

Blackmagic Web Presenter



Languages

To go directly to your preferred language, simply click on the hyperlinks listed in the contents below.

English	3
日本語	55
Français	108
Deutsch	161
Español	214
中文	267
한국어	320
Русский	373
Italiano	426
Português	479
Türkçe	532
Polski	585



Welcome

Thank you for purchasing your Blackmagic Web Presenter!

Blackmagic Web Presenter plugs directly into any SDI equipment, converts the signal into H.264 and lets you stream it on popular streaming services such as YouTube Live, Facebook Live and Twitch. You can also transmit broadcast quality video point to point using an optional ATEM Streaming Bridge. This makes transmission of professional video to remote locations easy using the internet!

This instruction manual shows you everything you need to know to get started with Blackmagic Web Presenter and how to use all the features and controls, including how to set everything up for YouTube Live, Facebook Live, Twitch, Zoom, Skype and more.

Check the support page on our website at www.blackmagicdesign.com for the latest version of this manual and for updates to your Blackmagic Web Presenter's internal software. When downloading the software, be sure to register with your information so we can keep you updated when new software is released.

We are continually working on new features and improvements, so we are keen hear from you!

A handwritten signature in black ink that reads "Grant Petty". The signature is written in a cursive, flowing style.

Grant Petty

CEO Blackmagic Design

Contents

Getting Started	5
Using Web Presenter's Front Panel	8
LCD Display	9
Using the Monitor Output	10
Using Web Presenter Setup	15
Live Stream Tab	16
Setup Tab	19
Network Settings	20
Setting Internet Sharing for Direct Streaming	20
Streaming Using Your Smartphone	21
Using Blackmagic Web Presenter as a Webcam	21
Setting up Open Broadcaster	21
Creating Video Links with ATEM Streaming Bridge	24
Creating the XML File	25
Exporting the XML File	25
Tally, Talkback and Camera Control	26
Connecting URSA Broadcast G2	27
Blackmagic Universal Rack Shelf	28
Contents	28
Mounting a Unit to the Rack Shelf	29
Attaching the 1/6 Blanking Panel	29
Attaching the Side 1/3 Width Blanking Panel	29
Updating the Internal Software	30
Developer Information	31
Blackmagic Web Presenter Ethernet Protocol	31
Protocol Blocks	33
Blackmagic Streaming XML Format	44
Overview	44
Streaming XML Definition	44
Help	51
Regulatory Notices	52
Safety Information	53
Warranty	54

Getting Started

Getting started with your Blackmagic Web Presenter is quick and easy! All you need to do is connect power, connect video and audio, connect the unit to your computer, then connect to the internet.

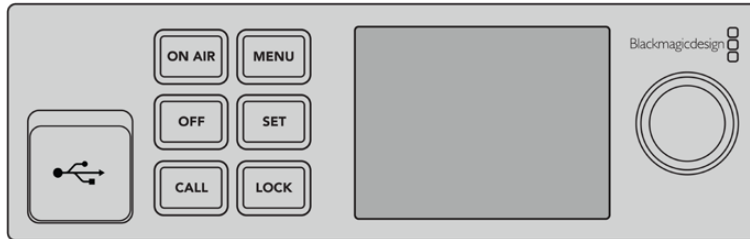

Blackmagic Web Presenter front panel

Connecting Power

Plug a standard IEC power cable into your Blackmagic Web Presenter's power input on the rear panel.

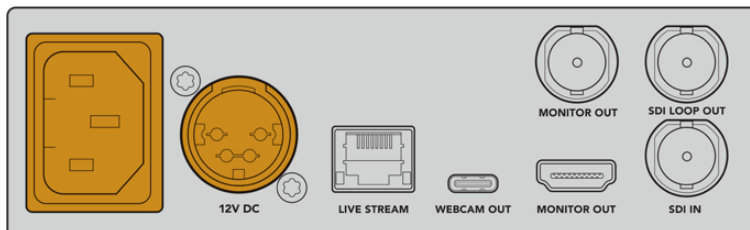

Blackmagic Web Presenter can be powered using the IEC or 12V DC power input

Web Presenter also has an additional 12V DC power input. You can use this input if you want to connect external power or redundancy via an external power supply, for example a UPS or external 12V battery.

Connecting Video and Audio

Plug your video source into Blackmagic Web Presenter's SDI input. When video is connected it will be displayed on your web presenter's built in LCD. Audio is embedded with the video on the SDI video signal and you can confirm it by observing the audio meters on the LCD.

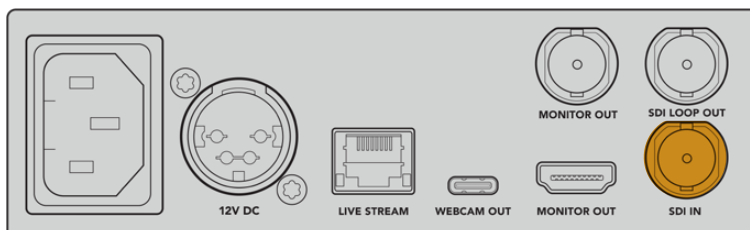

Connect video to your Blackmagic Web Presenter's SDI input

Blackmagic Web Presenter supports 12G-SDI and will automatically switch between HD and Ultra HD all the way up to 2160p60 when the video input changes. While Blackmagic Web Presenter 4K can stream in Ultra HD, Blackmagic Web Presenter HD will take virtually any video signal and convert down to 1080p.

Connecting a Monitor

Plug your HDMI television or SDI monitor into one of the monitor outputs. This lets you monitor your broadcast and observe important status information that updates constantly with your video stream. For more information on how to use the monitor output, refer to the 'Using the Monitor Output' section.

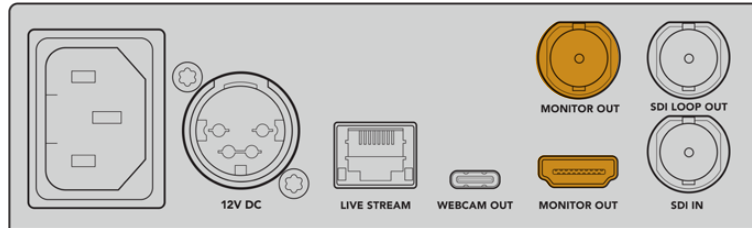

Connect a monitor to your web presenter's monitor output

Connecting to a Computer via USB

Connect your Web Presenter to your computer using the USB-C port on the front or rear panel. These USB ports are used for updating the unit and configuring it with the Blackmagic Web Presenter Setup utility. Once you have configured your Web Presenter for the first time, you can then disconnect the unit from the computer.

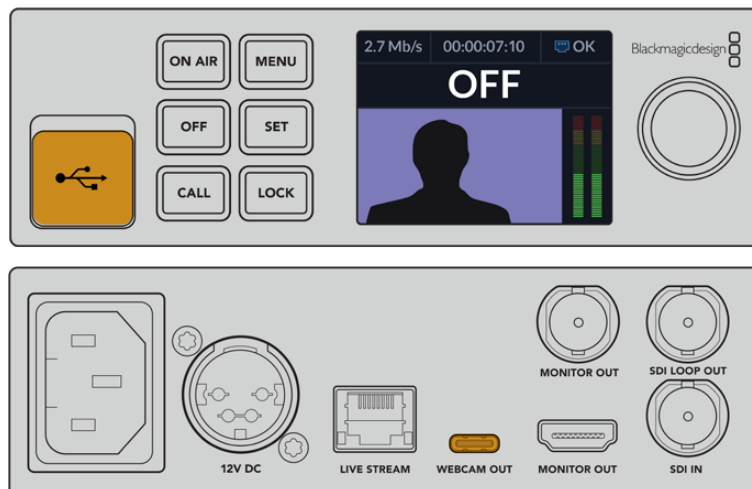

Connect your Blackmagic Web Presenter to your computer using the USB port on the front or rear panel

Connecting to the Internet

Connect your Blackmagic Web Presenter to the internet by plugging a network cable from the 'live stream' Ethernet port to an internet router or a network switch.

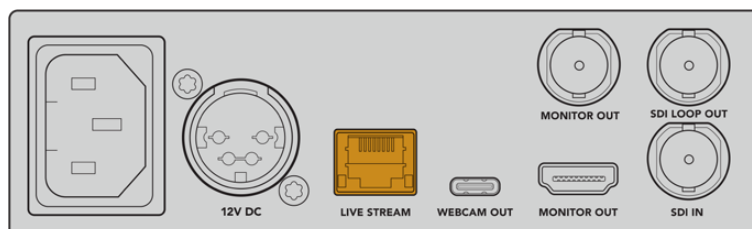

Connect your Blackmagic Web Presenter to your network via the Ethernet port on the rear panel

Setting up a Live Stream

You can now set up your Web Presenter to stream via any streaming platform such as YouTube Live, Facebook Live, Twitch and more. For this example, we will set up for a YouTube Live stream.

- 1 Copy your stream key from your YouTube Studio account.
- 2 Download the Blackmagic Web Presenter Setup utility from www.blackmagicdesign.com/support and install it on your computer. This software lets you configure streaming settings for the first time.
- 3 Launch the Blackmagic Web Presenter Setup utility and go to the 'live stream' page.
- 4 Set the platform to YouTube and the server to 'primary'. Paste your YouTube stream key into the 'key' field and select a streaming quality. Click 'save'.
- 5 You're now ready to start streaming to the world! Click the 'on air' button or press the 'on air' button on the unit's front panel. When your production has finished, press the 'off' button to stop your broadcast.

Using the SRT Streaming Protocol

The secure reliable transport protocol, or SRT, provides lower latency streaming when compared to RTMP. SRT also improves security by using a passphrase, which is like an encryption key.

When selecting the SRT protocol version of your streaming service, copy the passphrase and stream key from your streaming account and paste them into the 'key' and 'passphrase' fields of Blackmagic Web Presenter Setup utility.

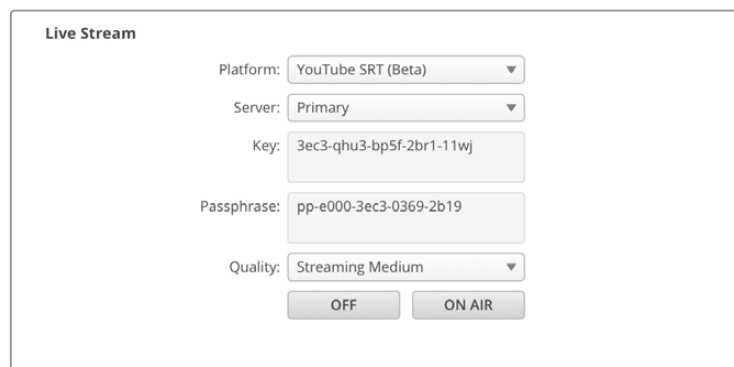

The screenshot shows the 'Live Stream' configuration window. It contains the following fields and controls:

- Platform: YouTube SRT (Beta) (dropdown menu)
- Server: Primary (dropdown menu)
- Key: 3ec3-qhu3-bp5f-2br1-11wj (text input field)
- Passphrase: pp-e000-3ec3-0369-2b19 (text input field)
- Quality: Streaming Medium (dropdown menu)
- OFF (button)
- ON AIR (button)

Paste your passphrase into the 'passphrase' field of setup utility

Both the protocol RTMP or SRT as well as the codec H.264 or H.265 can be changed in the XML file if technically experienced broadcasters want to customize streaming settings. For more information, refer to the 'Blackmagic Streaming XML Format' section.

Using Web Presenter's Front Panel

Use Blackmagic Web Presenter's front panel controls to start and stop streaming and change settings.

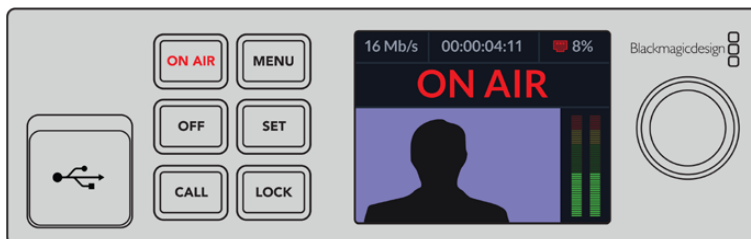

On Air - To start streaming, simply press the 'on air' button. The button will highlight red while streaming on air.



If the on air button flashes, it means a live stream has failed to start, or has stopped unexpectedly. This might be due to a problem with your internet connection or streaming settings. Check that your internet connection is working and your streaming settings are correct.

Off - To stop streaming, press the 'off' button.

Menu - Press the menu button to open the settings on the LCD.

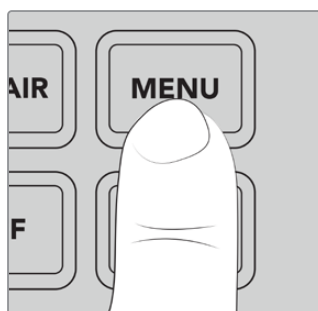

To change a setting:

- 1 Rotate the knob to select the setting you want to change, then press 'set'.

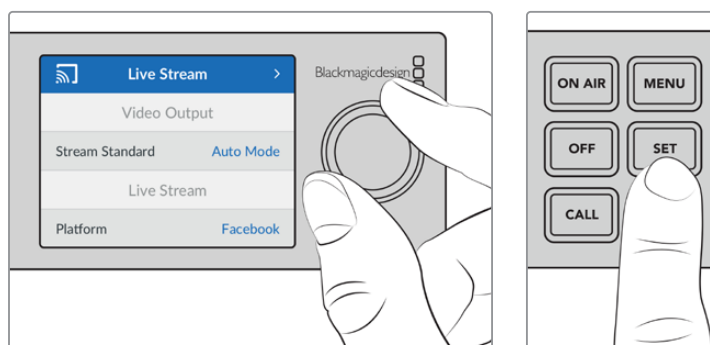

- 2 Rotate the knob to change your setting.
- 3 Press 'set' again to confirm the change.

Press the menu button to step back through the menu items and return to the home screen.

Call - This feature will be enabled in a future update.

Lock - Press and hold this button for 1 second to lock the panel. This disables the buttons, preventing anyone from accidentally going on air or stopping a stream. The button will illuminate red when active.



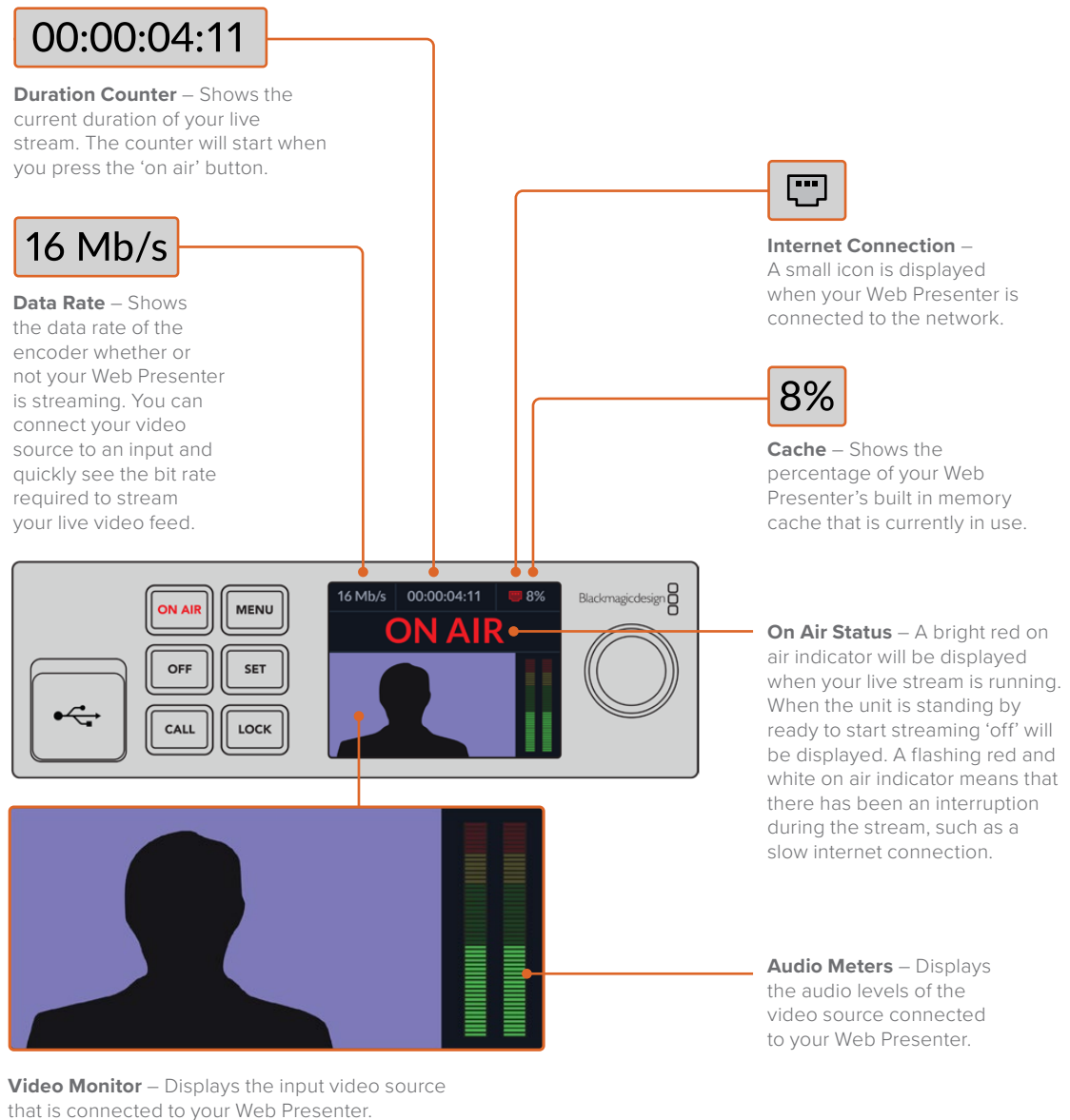

Press and hold for 2 seconds to unlock the panel.

LCD Display

The home screen is the first feature you'll see when you power up your Web Presenter. The home screen displays important information, including:



Internet Connection Icons

	A blue Ethernet icon is displayed when an Ethernet cable is connected and the Ethernet connection will be used for streaming.
	A red Ethernet icon is displayed when on air and streaming via Ethernet.
	A blue smartphone icon is displayed when a tethered smartphone's internet connection will be used for streaming.
	A red smartphone icon is displayed when on air and streaming via a tethered smartphone.

TIP If no icon is displayed then your Web Presenter is not connected to the network.

Using the Monitor Output

The monitor output lets you monitor the video input, audio levels, on air status, data rate and cache levels, plus technical information about the SDI input.



The screenshot shows the Blackmagic Web Presenter interface. At the top left, it says "ON AIR" with a timer at "00:00:00:02". Below this, the "Live Stream" section shows "Platform: YouTube", "Source: Primary", and "Protocol: RTMP". The "Video Input" section displays "Video Standard: 2160p24", "Colorspace: BT 709", and "OS: Android Data". The "Audio Input" section shows "Sample Frequency: 48kHz", "Sample Rate: 4,294,967,295", and "Main Audio". On the right, there is a vertical audio level meter ranging from -45 to +3. At the bottom, a "DATA RATE Mb/s" graph shows a value of "6.92" and a "CACHE" graph shows a value of "24%".

The monitor out on Blackmagic Web Presenter provides comprehensive information including data rate and cache status

The monitor output display is made up of 8 panels. Below is a description of each panel and the information it displays.

Input View

The main panel displays your current video input from the connected SDI video source.



On Air Status

Prior to streaming, the on air status indicator will display 'off' to let you know Web Presenter is standing by and ready to broadcast. When streaming begins, the indicator will display a bright red 'on air' status until streaming is stopped.

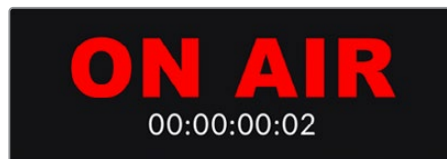

Underneath the on air indicator is the duration counter. When you press the on air button on your Web Presenter, the duration counter will start running.

If your Web Presenter is off air but will stream via a tethered smartphone, the 'off' indicator includes a blue smartphone icon in the corner. When on air, the smartphone icon will illuminate red.

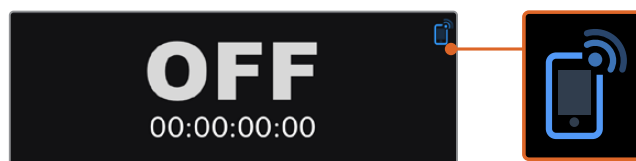

Live Stream

The live stream panel displays information about your live stream settings. This includes the streaming platform, server and protocol. It also displays the stream resolution and quality settings.

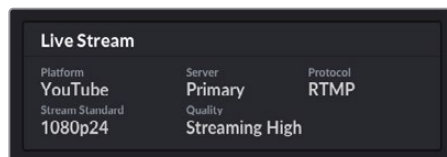

Video Input

The 5 mini viewers at the top of the video input panel show the previous 6 seconds of your live stream, each mini viewer represents 1.2 seconds of streaming time.

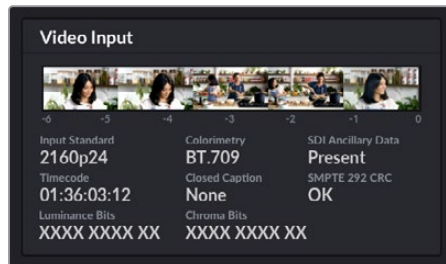

Below the mini viewers you can view detailed technical information about the video input source connected to your Web Presenter's SDI input.

Input Standard	Displays the resolution and frame rate of the SDI video input. Web Presenter supports up to 2160p60.
Colorimetry	Shows the color space of the SDI video input. Web Presenter supports Rec.601, Rec.709 and Rec.2020 color spaces.
SDI Ancillary Data	Ancillary data is data carried in the SDI video input that is in addition to video. This includes embedded audio, timecode and closed captions. If your SDI input includes ancillary data then 'Present' will be displayed.
Timecode	Displays the timecode from the SDI video input source.
Closed Captions	If your SDI video input includes Closed Captions the format will be displayed here. CEA-608 and CEA-708 formats are supported.
SMPTE 292 CRC	This is an error checking function for SDI video. If your Web Presenter detects a problem in the SDI video input it will display an error. CRC errors are usually caused by a faulty SDI cable or a cable that is too long.
Luminance Y Bits and Chroma Bits	<p>The indicators for 'luminance y bits' and 'chroma bits' show you the activity of the SDI video input signal. Each letter represents the state of one bit of the video signal.</p> <p>X - An 'X' indicates a constantly changing bit.</p> <p>L - A low bit.</p> <p>H - A high bit.</p> <p>SDI offsets are subtracted to make it easy to understand. For example, all bits are low when video is black.</p> <p>Generally, all 10 bits for your SDI video input will show 'X' to mean all the bits on your video stream are changing constantly. If your SDI input is 8 bit video, the two rightmost bits will always be 'L' as they don't have any data. If a bit stays 'L' or 'H' when you expect it to be 'X', this indicates a 'stuck bit' and could be the result of a fault in the upstream video.</p>

Audio Input

The audio waveform display at the top of the audio input panel shows the audio information for the past 6 seconds of your live stream. This is continually updated and scrolls from right to left.

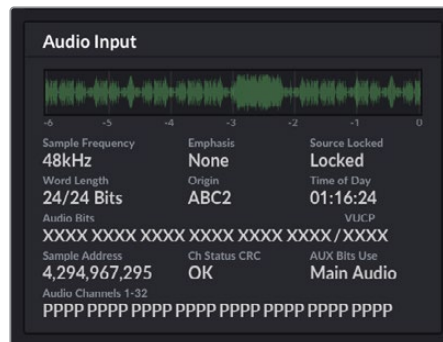

Below the audio waveform display you can view detailed technical information about the audio input.

Sample Frequency	Displays the sample frequency rate of the audio embedded in the SDI input.
Emphasis	Indicates if your audio source has its emphasis option enabled.
Audio Source Lock	Indicates whether the audio source frequency is locked to an external reference source.
Word Length	Shows the bit depth of the audio embedded in the SDI input.
Origin	These four characters indicate the channel origin.
Time of Day	Free run timecode.
Audio Bits	Shows the bit activity in the audio samples embedded in the SDI connection. Even if the audio channel status says you have 16, 20 or 24 bit audio, the audio bit activity will confirm it.
VUCP	Reading VUCP bits from left to right: the 'V' bit indicates 'valid', 'U' is the 'user' bit, 'C' is the 'channel status' bit, and 'P' is for 'parity'. This field is like 'audio bits'.
Sample Address	Audio sample counter.
AUX Bits Use	Indicates whether AUX bits are used for main audio.
Audio Channels 1-32	Each digit represents an embedded audio channel on the SDI input. A 'P' shows that an audio channel is in use and a '-' means that there is no audio on that channel.

Data Rate Display

The data rate display shows the current data rate of the encoder over the past 60 seconds. The data rate is measured in megabits per second. This indicator runs consistently, even when off air, so you can accurately gauge your bandwidth before going on air.

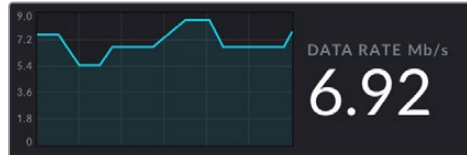

Cache Display

The cache display shows the percentage of your Web Presenter's built in memory buffer that is currently in use and the graph shows the amount used over the past 60 seconds. The cache is a small amount of internal memory that continuously records and plays the program output. It acts as a safety measure if the streaming data rate decreases below a level able to sustain video.

The variable nature of the internet is mostly due to network activity or wireless signal strength, so if the broadcast data rate decreases, the buffer data will increase accordingly. If the connection speed becomes slow enough that it cannot support the video stream, the cache will fill with video frames to compensate. However, once the cache is 100% full, the video stream will be compromised, so you will want to avoid a full cache where possible. You can run a test by connecting a video feed and watching the cache display in the monitor output without having to start the stream. If the cache frequently approaches 100%, choose a lower quality in the live stream settings.

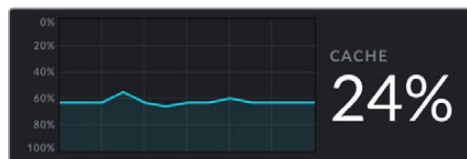

Audio Meters

You can monitor the levels of your audio source using the audio meters. These can be set to display either PPM or VU levels in the Web Presenter's menu settings. If your audio levels are too high the meters will illuminate red and may mean that the audio in your live stream could become distorted or clipped. Ideally try to keep your audio towards the top of the green section and occasionally in to the yellow section.

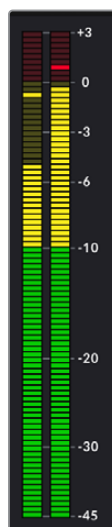

Using Web Presenter Setup

When your Blackmagic Web Presenter is connected to a network, any computer connected to the same network can be used to control your Web Presenter remotely. With Blackmagic Web Presenter Setup, you can access the same controls and settings that are available on the unit's front panel.

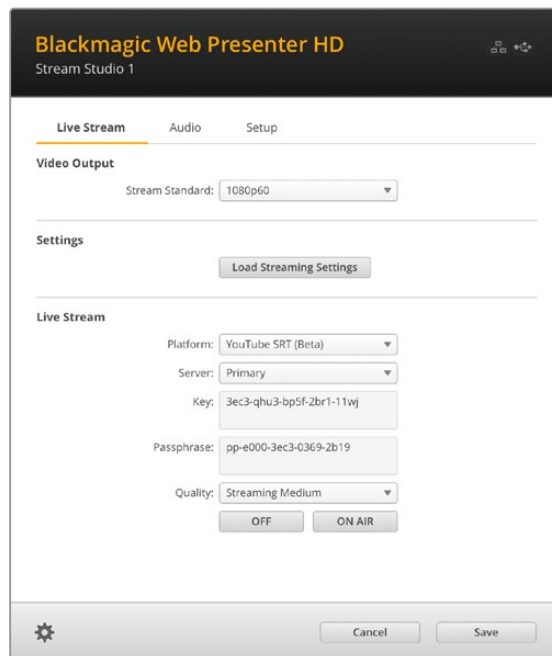
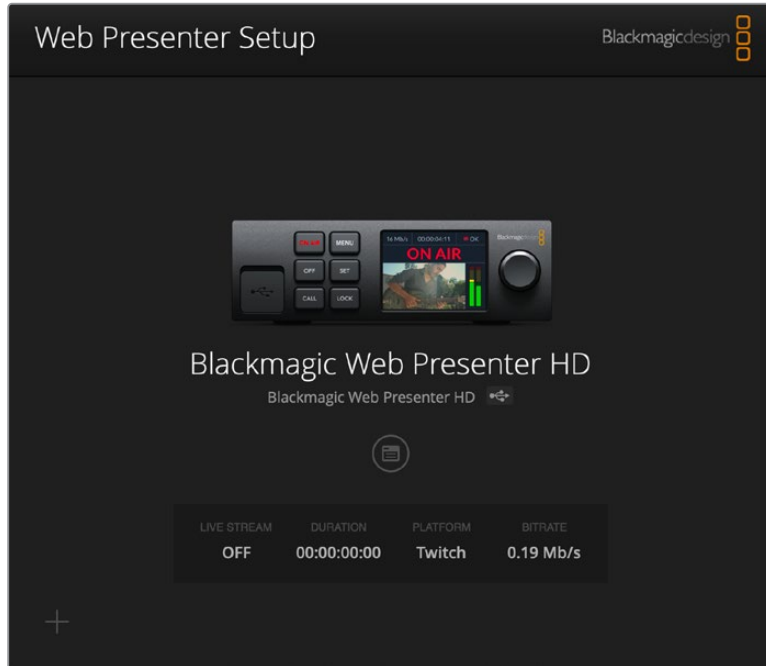

Live Stream Tab

Video Output

Stream Standard

Click on the 'stream standard' menu to select the video resolution setting for your stream. You can choose from 720p25 up to 1080p60 or 2160p60 depending on which Web Presenter model you are using.

Settings

If you have custom streaming settings, for example an XML file from a Blackmagic ATEM Streaming Bridge, you can import them by clicking the 'load streaming settings' button.

For more information on creating custom settings and connecting to ATEM Streaming Bridge, refer to the 'Creating Video Links with ATEM Streaming Bridge' section later in this manual.

Live Stream

Platform

Click the 'Platform' menu to select the streaming platform for your broadcast. Options include YouTube, Facebook and Twitch. If you have imported custom streaming settings they will also appear in the platform list.

To stream to a custom URL, select a custom URL option from the 'platform' menu. On Web Presenter 4K you can choose to stream to a custom URL using H.264 or H.265, on Web Presenter HD you can stream to a custom URL using H.264.

Server

Select the server that is closest to your location by selecting it from the list. The server list will vary depending on your chosen streaming platform.

If you are streaming to Instagram, Microsoft Teams, or to a custom URL, the server list will be an editable field. Enter the URL assigned from your streaming platform account or custom URL details.

Key

Enter the streaming key that has been assigned to your broadcast from the streaming platform.

Passphrase

If you are using a streaming service with the SRT streaming protocol, enter the passphrase assigned from your streaming platform account.

Quality

Select the streaming quality for HD or 4K, depending on which Web Presenter model you are using.

H.264	
HD	4K
HyperDeck High 45 to 70 Mb/s	HyperDeck High 95 to 220 Mb/s
HyperDeck Medium 25 to 45 Mb/s	HyperDeck Medium 66 to 150 Mb/s
HyperDeck Low 12 to 20 Mb/s	HyperDeck Low 38 to 80 Mb/s
Streaming High 6 to 9 Mb/s	Streaming High 34 to 51 Mb/s
Streaming Medium 4.5 to 7 Mb/s	Streaming Medium 23 to 35 Mb/s
Streaming Low 3 to 4.5 Mb/s	Streaming Low 13 to 20 Mb/s

H.265	
HD	4K
Streaming High 2.3 to 4.5 Mb/s	Streaming High 22.5 to 30 Mb/s
Streaming Medium 1.5 to 3 Mb/s	Streaming Medium 14 to 20 Mb/s
Streaming Low 0.8 to 2 Mb/s	Streaming Low 8 to 10 Mb/s

The data rate used by the quality setting will change depending on the video standard Web Presenter is using. For example, if you select 'streaming high' quality and are running at 1080p24 then it would use the 6 Mb/s data rate.

As you can see in the table, the streaming data rates are lower compared to the HyperDeck rates. This allows for transmitting data over the internet which typically uses a lower bandwidth compared to recording data on a disk.

You will notice that each setting has 2 data rates mentioned. The lower number is used for the lower frame rates of 24p, 25p and 30p, while the higher data rates are used when you are running higher frame rates of 50p and 60p. It's also worth noting that the default setting for the streaming quality is Streaming High, as this gives a very high quality streaming channel.

Off and On Air buttons

You can start or stop a live stream by using the 'off' and 'on air' buttons. The 'on air' button illuminates red when a live stream is in progress.

Remove Imported Settings

To remove all imported streaming settings from your Web Presenter, click the cog icon at the bottom left of the 'live stream' tab. To confirm your choice click 'remove'.

Audio Tab

The audio tab contains options to configure your Web Presenter's audio monitoring output and audio meters.

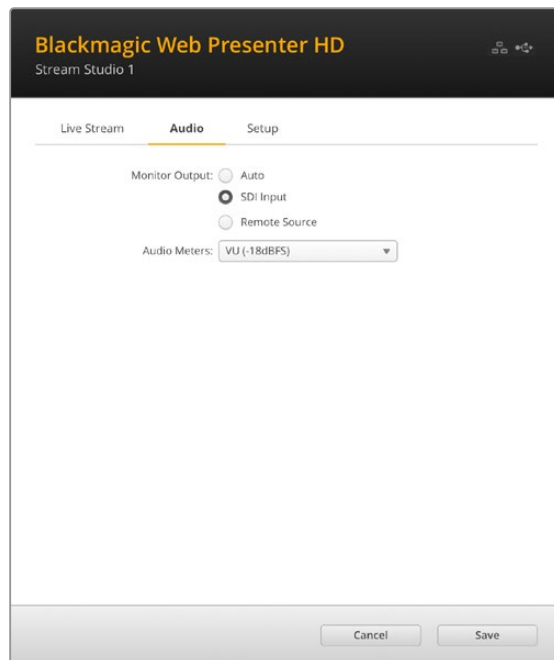

Monitor Output

Use the monitor output options to choose the audio source used for your Web Presenter's SDI and HDMI monitoring outputs.

Auto

When the monitor output is set to 'auto', your Web Presenter will automatically detect and monitor talkback audio being sent from an ATEM Switcher via an ATEM Streaming Bridge. If no talkback is detected, audio from the SDI input will be used.

SDI Input

Select 'SDI input' to monitor the audio from your Web Presenter's SDI input source, for example a connected Blackmagic Studio Camera.

Remote Source

Use this option to monitor talkback audio sent from a remote ATEM switcher or an ATEM Streaming Bridge.

Audio Meters

Choose the type of audio meter to display using the audio meters menu. The options available are VU -18dBFS, VU -20dBFS, PPM -18dBFS or PPM -20dBFS reference levels.

Setup Tab

The screenshot shows the 'Setup' tab of the Blackmagic Web Presenter HD interface. At the top, there are three tabs: 'Live Stream', 'Audio', and 'Setup', with 'Setup' being the active tab. Below the tabs, there are three input fields: 'Name' (containing 'Stream Studio 1'), 'Language' (a dropdown menu set to 'English'), and 'Software' (containing 'Version 3.3'). Below these is a 'Network' section with a refresh icon. It includes radio buttons for 'Protocol' (DCHP and Static IP, with Static IP selected), input fields for 'IP Address' (192.168.24.100), 'Subnet Mask' (255.255.255.0), 'Gateway' (192.168.24.1), 'Primary DNS' (8.8.8.8), and 'Secondary DNS' (8.8.4.4). There are also radio buttons for 'Connection Priority' (Ethernet and Mobile, with Mobile selected). At the bottom of the network section is a 'Reset' section with a 'Factory Reset' button. At the very bottom of the interface are 'Cancel' and 'Save' buttons.

Name

If you want to rename your Web Presenter, type a new name into the box and click 'save'.

Language

Lets you change the unit's language setting.

Software

Displays Web Presenter's current software version.

Network

These settings allow you to configure options such as choosing between connecting to a network over DHCP or using a static IP address. For more information on connecting your Web Presenter to a network, refer to the 'network settings' section.

Connection Priority - When Ethernet and a mobile phone are both connected to the Web Presenter, this setting lets you choose which connection will be used for streaming. For more information on mobile tethering, refer to the 'streaming using your smartphone' section

Reset

Reset your Web Presenter by clicking the 'factory reset' button.

Network Settings

Your Web Presenter can connect to the network using a static IP address or by using DHCP.

DHCP - will automatically set an IP address for your unit and connect it to your network without any settings changed.

The dynamic host configuration protocol, or DHCP, is a service on network servers and routers that automatically finds your Web Presenter and assigns an IP address. DHCP makes it easy to connect equipment via Ethernet and make sure that IP addresses do not conflict with each other. Most computers and network switches support DHCP.

Static IP - If you want to set the IP address yourself, simply set the protocol setting to 'static IP' and change the IP settings manually.

A static IP address is one that won't change even if your Web Presenter is rebooted.

Using a static IP address might be necessary if your connecting your Web Presenter to a corporate network. If you have a network administrator, it's possible your network might have custom IP addresses for all the equipment connected to it. It's best to check with your network administrator if they are managing your computers and network in your company.

Setting Internet Sharing for Direct Streaming

If you are unable to plug Web Presenter directly into a network switch or internet router, you can share your computer's internet connection with Web Presenter through its Ethernet port.

To set up Blackmagic Web Presenter for direct streaming:

- 1 Set your Web Presenter to use DHCP.
- 2 Configure your computer to share its internet connection through its Ethernet port.

Mac: in System Preferences, click 'sharing' then select 'internet sharing' from the 'service' list. In the 'share your connection from' menu, choose 'wi-fi' if your Mac is connected to the internet over wifi. In the 'to computers using' list, select 'ethernet'. In the 'service' list, tick the 'internet sharing' checkbox. When you are asked if you are sure you want to turn on internet sharing, click 'start'.

Windows: right click the 'start' icon and select 'network connections'. The 'network status' screen appears. Click on 'change adapter options'. This lists your computer's network connections. Right click on the internet connection and select 'properties'. On the 'sharing' tab, tick 'allow other network users to connect through this computer's internet connection'. Select a network connection in the menu then click 'OK'.

- 3 Plug Web Presenter into your computer's Ethernet port. After a few seconds, DHCP assigns an IP address to Web Presenter.
- 4 Confirm your Web Presenter is connected to the internet via Ethernet by observing Ethernet icon in the top right corner on the unit's LCD screen.

Streaming Using Your Smartphone

Blackmagic Web Presenter is able to stream by tethering to your smartphone. This means you can stream to the world from any location where your smartphone has a cellular connection.

To set up mobile tethering:

- 1 Connect your smartphone to Blackmagic Web Presenter using a USB-C cable. You can use the USB-C connector on the front or back panel.
- 2 Enable your smartphone's internet hotspot.

On your iOS device open settings > personal hotspot and make sure 'allow others to join' option is on. On your Android device swipe the screen to display the quick menu. Press and hold the hotspot icon and then turn on USB tethering.

Now you can press the 'on air' button on your Blackmagic Web Presenter to go live.

TIP Once you've finished streaming, we recommend you switch off tethering connections to save your smartphone's battery life.

If your Web Presenter had an Ethernet cable connected, you are advised to confirm it is configured to use mobile internet tethering. Open the Web Presenter Setup utility and go to the 'setup' tab. In the 'network' section, set the connection priority to 'mobile'.

Using Blackmagic Web Presenter as a Webcam

Software such as Skype or Zoom should automatically set Web Presenter as the webcam, so when you launch the application you will see video from your Web Presenter immediately. If the application doesn't select Web Presenter automatically, manually set it to use Web Presenter as the webcam and microphone.

Below is an example of how to set the webcam settings on Skype.

- 1 In Skype's menu bar, open the 'video and audio settings'.
- 2 Click on the 'Camera' menu and select your Web Presenter from the list. You will see the video from Web Presenter appear in the preview window.
- 3 Go to the 'Microphone' menu and select your Web Presenter as your audio source.

Setting up Open Broadcaster

Open Broadcaster is an open source application that works as a streaming platform between your Web Presenter and your favorite streaming software like YouTube, Twitch, Facebook Live and others. Open Broadcaster compresses your video to a bit rate that is easily managed by your streaming app.

Below is a demonstration of how to set up Open Broadcaster to stream the webcam output from your Web Presenter using YouTube Live as the streaming service.

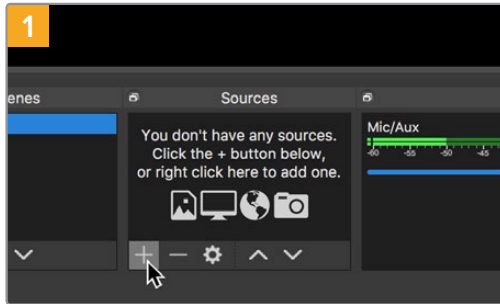

Launch Open Broadcaster and click on the plus symbol in the 'sources' box.

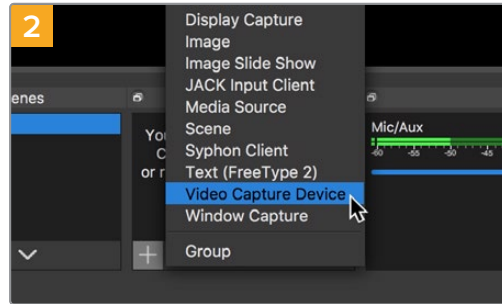

Select 'Video Capture Device'.

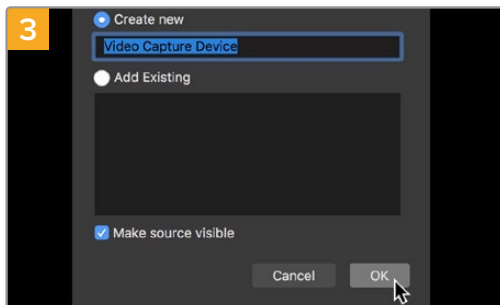

Name the new source and click 'OK'.

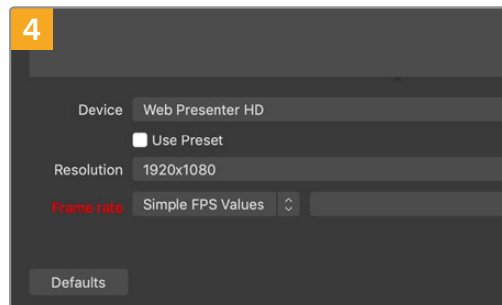

In the device menu, select your Web Presenter model and click 'OK'.

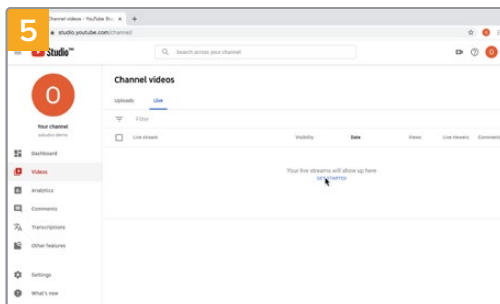

Now go to your YouTube account. Click on the 'go live' button then click 'stream'.

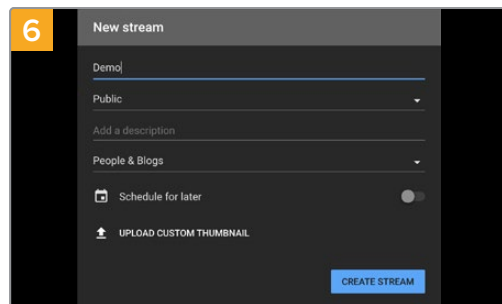

In the YouTube 'stream' options, enter your broadcast details and click 'create stream'.

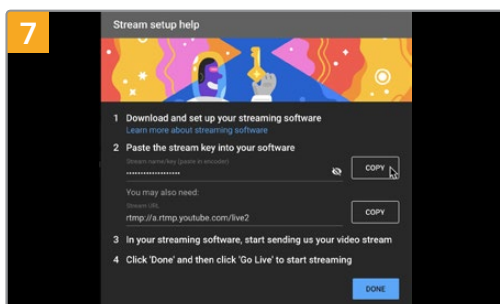

YouTube will now generate a stream key that will direct Open Broadcaster to your YouTube account.

Click the 'copy' button next to the stream key. Copy the stream key that you will now paste into Open Broadcaster.

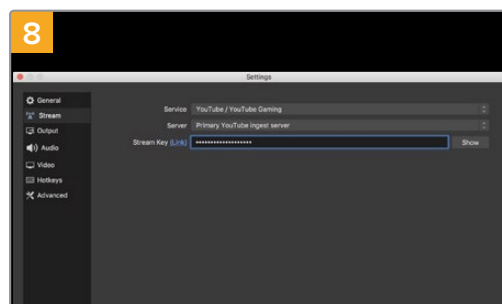

Return to Open Broadcaster and open the preferences by clicking on 'OBS/preferences' in the menu bar. Select 'stream'. Now paste in the stream key you copied from YouTube and click 'OK'.

You will now see the video from your Web Presenter in the Open Broadcaster streaming preview window.

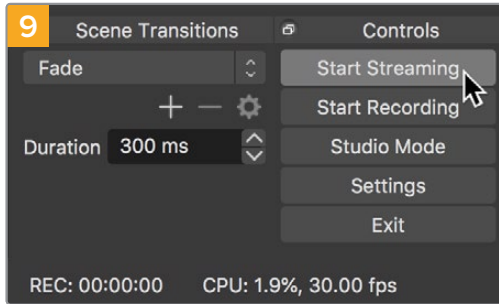

To connect Open Broadcaster's broadcast link to YouTube, click 'start streaming' in the bottom right corner of the screen. This establishes the link to YouTube from Open Broadcaster and from here everything will now be set using YouTube Live.

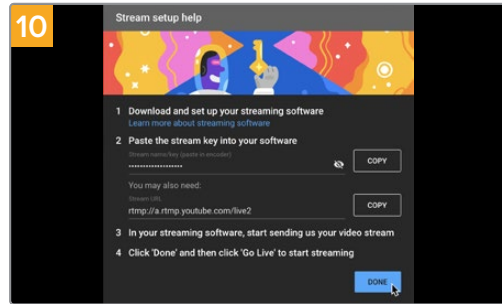

Go back to YouTube Live and you will see the webcam program output from your Web Presenter in the background. Click 'done'.

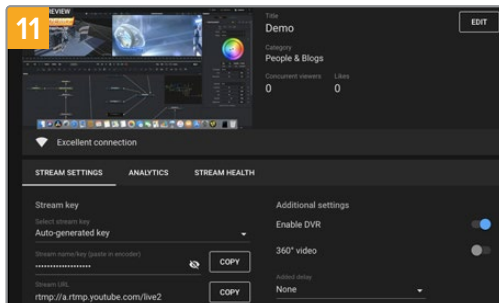

With Open Broadcaster now communicating with YouTube Live, you are ready to begin your broadcast. Now it's time to perform your final checks and make sure everything is good.

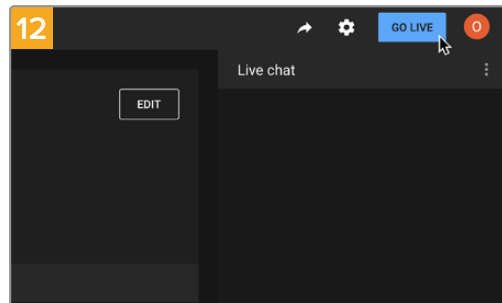

If you are all set, you can now begin your broadcast by clicking 'go live'.

You are now broadcasting live on YouTube with Open Broadcaster.

NOTE Due to the nature of internet streaming there can often be a delay, so it's important to watch the stream on YouTube and confirm your program has finished before clicking 'end stream' to make sure you don't accidentally cut the end of your broadcast short.

Creating Video Links with ATEM Streaming Bridge

The ATEM Streaming Bridge allows you to decode the streaming video from any Web Presenter and convert it back to SDI or HDMI video. It allows you to send video over your local network, or to anywhere in the world via the internet.

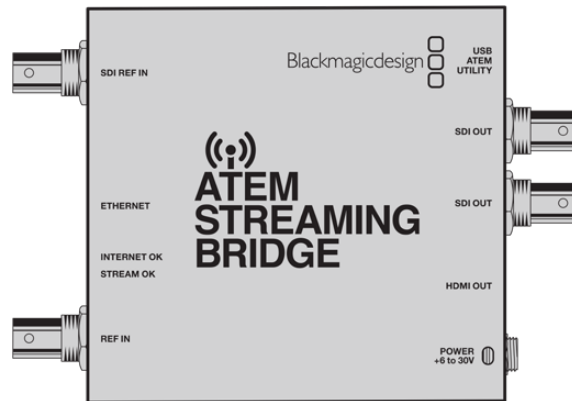

If your ATEM Streaming Bridge is connected to the same local network as your Web Presenter, it will be listed in the 'platform' menu on the live stream tab in Web Presenter Setup.

Otherwise, you can load a streaming setting XML file on a USB drive connected to the Web Presenter or via your computer using Web Presenter Setup.

A good example of how Blackmagic Web Presenter can work with ATEM Streaming Bridge is transmitting a weather report to a studio from a remote location. All you need for transmission from location is a Web Presenter and an internet connection, which could be your smartphone or by connecting to a network.

Back at the studio, the ATEM Streaming Bridge takes the internet feed and converts it to SDI so it can be connected to the main switcher at the studio.

The workflow setup for this example would be:

- 1 On location, the Blackmagic Web Presenter is connected to the Program SDI output on the switcher. For example an ATEM Constellation 8K.
- 2 Blackmagic Web Presenter is then connected to a Smartphone.
- 3 Back at the studio, ATEM Streaming Bridge is also connected to the internet via Ethernet.
- 4 The ATEM Streaming Bridge then sends the converted SDI video feed from the internet to the studio switcher's SDI input for the main news broadcast.

For your studio to connect ATEM Streaming Bridge to the Web Presenter's internet feed, you will need to launch the ATEM Setup utility and configure the internet settings. This includes generating an XML file containing all the streaming settings which are then loaded into the Web Presenter on location.

Creating the XML File

To create an XML settings file connect ATEM Streaming Bridge to the internet by plugging a network cable from the 'Ethernet' port to an internet router or network switch.

Connect ATEM Streaming Bridge to your computer using a USB-C cable and launch ATEM Setup.

In the setup tab, confirm the network settings are correct and select 'internet' from the 'stream service' options. You should see a 'visible worldwide' message in the internet status box. This means everything is working correctly.

A Note About Port Forwarding

If you see a port forwarding or UPnP error in the 'internet status' box you will need to ask your internet provider or network administrator to set up port forwarding on your internet connection to 'TCP port 1935'.

Exporting the XML File

Once you have confirmed your settings in the ATEM Setup tab and have successfully connected your ATEM Streaming Bridge to your network or the internet, you can export the XML setup file.

- 1 Click the 'external ATEM Mini Pro' tab in the top right of the window.

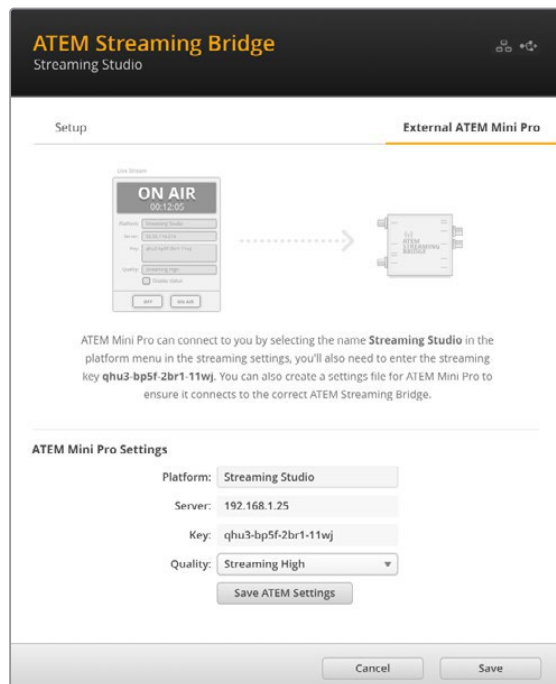

- 2 To give the platform a custom name, click in the 'platform' box and type a new name. This name will be the name listed in the remote Blackmagic unit's platform menu.
- 3 Select the quality you want to stream. This setting will set the quality setting in the remote Web Presenter.
- 4 Click the 'Save ATEM Settings' button, choose a location on your computer to save the XML file and click 'save'.
- 5 You can now email the saved XML file to the remote operator.

TIP You can use the talkback settings in ATEM Setup to select which audio channels you want to send back to the remote Web Presenter.

Loading the XML File

With the settings file emailed to the location, the location crew simply loads the XML into the Web Presenter using Blackmagic Web Presenter setup, then presses on air to start streaming the weather report to the studio!

It’s important to mention that once you have loaded the streaming XML file, you can then start and stop streaming without ever having to load it again. This makes it easy to set up a constant video link between the Web Presenter and the ATEM Streaming Bridge.

As long as the ATEM Streaming Bridge at the studio hasn’t changed the streaming and network settings and is still looking for that Web Presenter, it will always find it no matter where it is on the internet. At any location, you can simply plug your Web Presenter into the internet, press ‘on air’, and it will immediately be streaming to the ATEM Streaming Bridge back at the studio.

You can find more details on how to use ATEM Streaming Bridge in the ATEM Mini manual which can be downloaded at www.blackmagicdesign.com/support

Tally, Talkback and Camera Control

ATEM Streaming Bridge and Blackmagic Web Presenter also allow ATEM switchers to send tally, talkback and camera control information. This means any SDI based Blackmagic Design camera can be positioned at any location within your local network, or anywhere in the world via the Internet and still have tally, talkback and camera control functionality.

It is very simple to set up. The illustration below shows how to connect an URSA Mini Pro 4.6K to an ATEM Constellation 8K over a local network with tally, talkback and camera control.

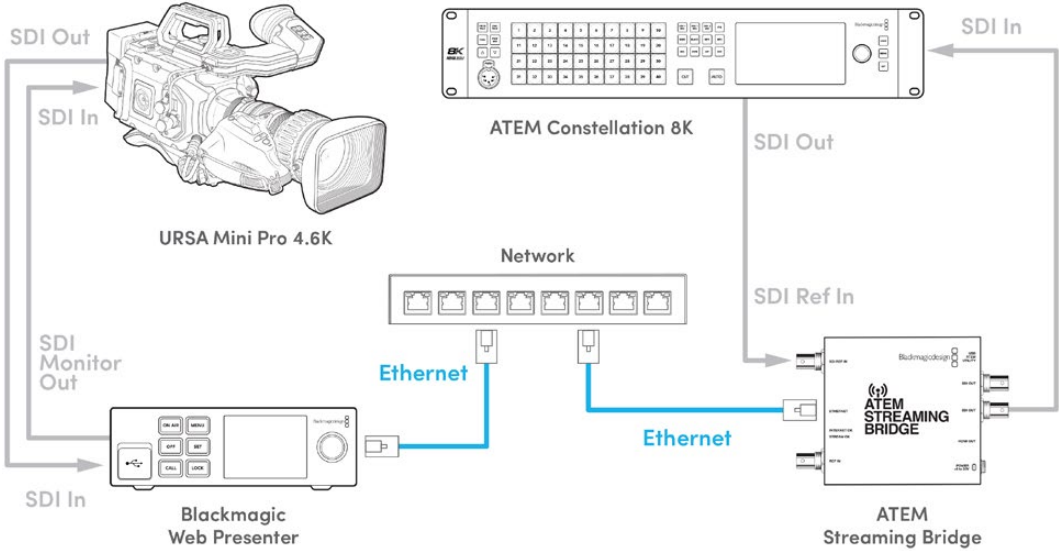

When everything is connected:

- 1 Press the 'menu' button on Blackmagic Web Presenter to open the LCD menu and navigate to the 'live stream' menu.
- 2 Select the ATEM Streaming Bridge in the 'platform' setting.
- 3 Press 'set' to confirm.

For tally to work, you need to make sure the camera has the ATEM camera ID set to match the input on the switcher. For information on how to set the ATEM Camera ID, refer to the URSA Mini manual.

You can test that tally is working by switching the camera to the program output on the ATEM switcher. If the ATEM camera ID is set correctly on your camera, you will see the tally light illuminate including a red tally border around the camera's LCD. Now switch the camera to the preview output and the tally will illuminate green.

Try adjusting the iris and pedestal in ATEM Software Control's camera page to test camera control.

Embedded SDI audio channels 15 and 16 are set as the default talkback channels but you can change them to engineering channels 13 and 14, or the program output using the ATEM Setup utility.

When transmitting over the Internet, an XML setup file is created using the ATEM Setup utility. This XML file is then loaded into Blackmagic Web Presenter so it can find the ATEM Streaming Bridge on the Internet. For more information on how to create and load the setup XML file, refer to the previous section in this manual.

Connecting URSA Broadcast G2

URSA Broadcast G2 has a built in streaming engine which means you don't need to use a Blackmagic Web Presenter as the camera can stream directly from its USB-C expansion port. Refer to the URSA Broadcast G2 manual for more information, including how to set the ATEM camera ID so tally works correctly.

Blackmagic Universal Rack Shelf

Blackmagic Universal Rack Shelf is a 1RU shelf that lets you install a broad range of Blackmagic Design equipment into a broadcast rack or road case. The modular design means you can build portable and practical equipment setups using products that share a single rack unit form factor.

The illustration below shows 3 Universal Rack Shelves installed in a small rack with a combination of compatible units mounted. The bottom shelf includes a 1/3 rack width blanking panel to fill unused space between units.

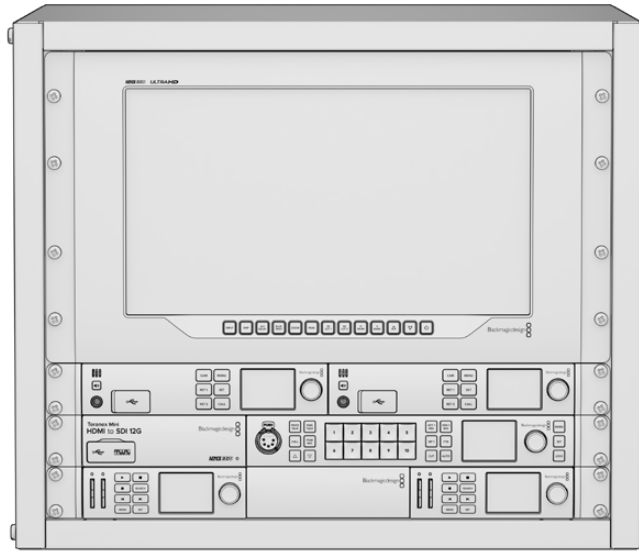

Contents

The Universal Rack Shelf Kit contains the following items.



1 x Blackmagic Universal Rack Shelf

A single rack unit, full width shelf for installing Blackmagic Design equipment.

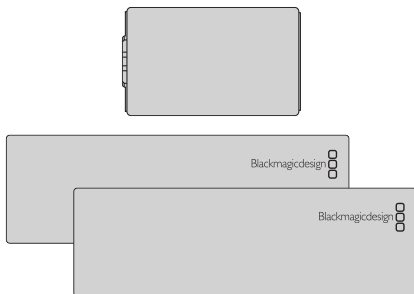

Blanking Panels

1 x 1/6 rack width and 2 x 1/3 rack width blanking panels to cover unused shelf space.

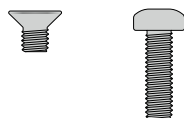

Screws

12 x M3 5mm countersunk mounting screws.

2 x M3 9mm flat screws for 1/6 blanking panels.

Mounting a Unit to the Rack Shelf

- 1 If rubber feet are attached, remove the feet from the base of the unit using a plastic edged scraping tool.
- 2 With both the rack shelf and the unit upside down, line up the rack shelf's pre drilled holes with the threaded mounting holes on the base of the Blackmagic Design unit. There are two central mounting points on 1/3 width units and up to three mounting points on larger, 1/2 rack width units.

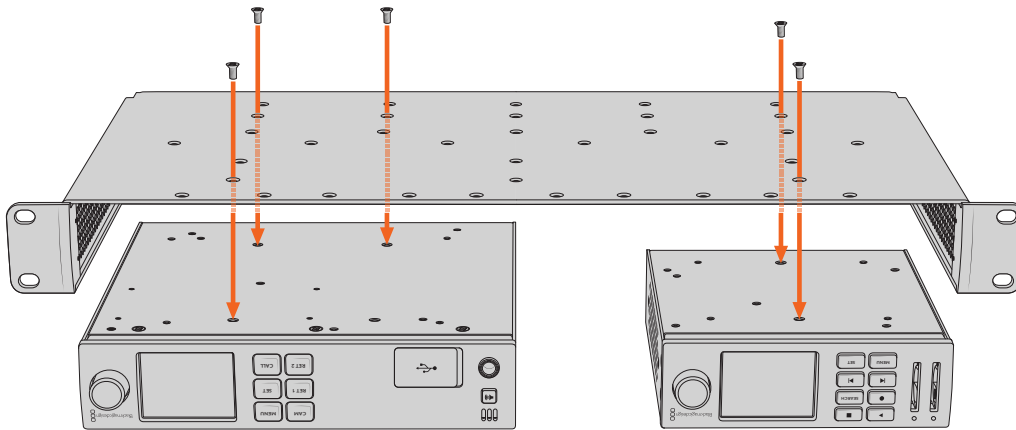

- 3 Using the supplied M3 5mm countersunk screws, fasten the unit to the rack shelf.
- 4 Once fastened, turn the rack shelf right side up and install into the rack via the built in rack ears.

The supplied blanking panels can be used to cover unused shelf space.

Attaching the 1/6 Blanking Panel

The small 1/6 blanking panel can be used to fill unused shelf space when mounting 1/2 and 1/3 rack width units. The panel can be attached to the sides of either unit. To improve airflow it's a good idea to mount the panel between units.

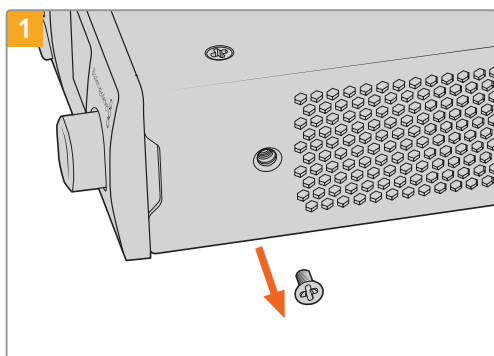

Remove the 5mm M3 screw near the front of the unit

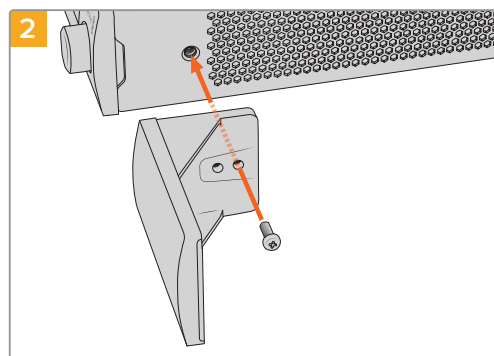

Line up the blanking panel and attach using the supplied M3 9mm nylon screw

Attaching the Side 1/3 Width Blanking Panel

The large 1/3 width blanking panels can be attached directly to either side of the rack shelf when mounting single units. To install a blanking panel, align the screw holes and anchor point at the base of the panel with the shelf and secure in place using two of the supplied M3 5mm countersunk screws.

Updating the Internal Software

The setup utility lets you update your Web Presenter's internal software in addition to configuring the streaming settings, network settings and streaming quality.

To update the internal software:

- 1 Download the newest Blackmagic Web Presenter installer from www.blackmagicdesign.com/support.
- 2 Run the Blackmagic Web Presenter installer and follow the onscreen instructions.
- 3 After installation is complete, connect your Web Presenter to the computer via the USB connector on the rear panel or on the front panel under the plastic dust cover.
- 4 Launch Blackmagic Web Presenter Setup and follow any onscreen prompt to update the internal software. If no prompt appears, the internal software is up to date and there is nothing further you need to do.

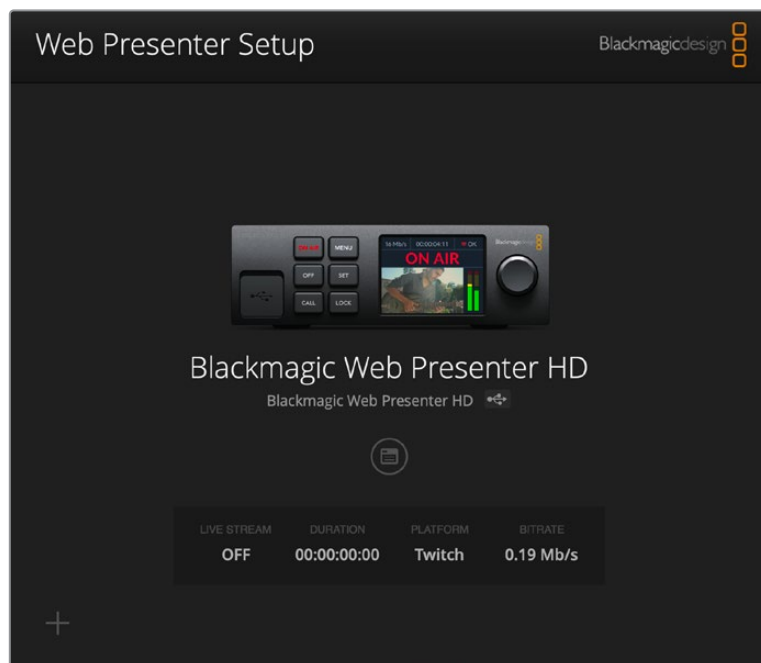

Download the latest setup utility for your Blackmagic Web Presenter from the Blackmagic Design support center at www.blackmagicdesign.com/support

Developer Information

Blackmagic Web Presenter Ethernet Protocol

v1.2

Protocol Details

Overview

The Blackmagic Web Presenter Ethernet Protocol is a line-oriented, text-based protocol to control a Web Presenter.

Lines from the Web Presenter server will be separated by an ASCII LF sequence.

Messages from the user may be separated by LF or CR LF.

Connection

The Web Presenter server is accessed by connecting to TCP port 9977 on a Web Presenter.

Connection Response

Upon connection, the Web Presenter server sends a dump of the device's state.

The Web Presenter server sends information in blocks, with each having an identifying header followed by a colon. A block spans multiple lines and is terminated by a blank line. Each line in the protocol is terminated by a newline character.

Following the header, a block contains either a single multi-line string or a sequence of key/value pairs arranged one per line. The first full-colon on a line is used to delimit the key and the value. A value may be a comma separated list. In this case, values in the list must have the “,” and “\” characters escaped with a “\” character.

To be resilient to future protocol changes, clients should ignore blocks they do not recognize, up to the trailing blank line. Within recognized blocks, clients should ignore keys they do not recognize.

Legend	
↵	End of line
...	and so on
Orange Text	Client Generated
Grey Text	Server Generated

The protocol preamble block is always the first block sent by the Web Presenter server:

```
PROTOCOL PREAMBLE:↵
Version: 1.2↵
↵
```

The version field indicates the protocol version. When the protocol is changed in a compatible way, the minor version number will be updated. If incompatible changes are made, the major version number will be updated.

The initial status dump is concluded by the end prelude block:

```
END PRELUDE:↵
↵
```

Status Updates

When any device parameter is changed on the Web Presenter server by any client, such as the Blackmagic Web Presenter Setup utility, the Web Presenter server resends the applicable status block, containing only the items that have changed. Status updates can also occur due to external changes such as tethering to a smartphone or when a streaming service is disconnected.

For example, if the input video mode is set to Auto, the following block will be sent:

```
STREAM SETTINGS:↵  
Video Mode: Auto↵  
↵
```

Requesting Changes

To change one or more parameters in a block, the client should send the appropriate block header in the same form the Web Presenter server sends, followed by the key/value pairs to be changed. For example, to change the input video format to 1080p59.94, the user should send the following block:

```
STREAM SETTINGS:↵  
Video Mode: 1080p59.94↵  
↵
```

The block must be terminated by a blank line. On receipt of a blank line, the Web Presenter server will either acknowledge the request by responding:

```
ACK↵  
↵
```

or if unable to parse the block responding with:

```
NACK↵  
↵
```

After a positive response, the client should expect to see a status update from the Web Presenter server showing the status change. This is likely to be the same as the command that was sent, sometimes followed by other blocks providing data specific to the change.

```
STREAM SETTINGS:↵  
Video Mode: 1080p59.94↵  
↵
```

If the Web Presenter server does not understand a key in the requested block, the key will be ignored. If an invalid value is provided for a known key, then the request is ignored and the Web Presenter will respond with the existing value for the key. In both cases the Web Presenter server will still respond with an ACK.

```
STREAM SETTINGS:↵  
Video Mode: UnsupportedMode↵  
↵  
ACK↵  
↵  
STREAM SETTINGS:↵  
Video Mode: 1080p59.94↵  
↵
```

Requesting a Status Dump

The user may request that the Web Presenter server resend the complete state of any status block by sending the block header, followed by a blank line. In the following example, the user requests the Web Presenter server resend the stream settings:

```
STREAM SETTINGS:↵
↵
ACK↵
↵
STREAM SETTINGS:↵
Video Mode: 1080p59.94↵
...
↵
```

Protocol Blocks

Identity Block

The identity block contains information to identify the connected Web Presenter.

Block Syntax

The following example shows the Identity Block for a Blackmagic Web Presenter HD.

```
IDENTITY:↵
Model: Blackmagic Web Presenter HD↵
Label: Blackmagic Web Presenter HD↵
Unique ID: 00112233445566778899AABBCCDDEEFF↵
↵
```

Parameters

Key	Read/Write	Description	Valid Values
Model	Read only	The Web Presenter model name	String
Label	Read/Write	A display name for the Web Presenter	String
Unique ID	Read only	A device specific unique identifier	Hexadecimal ID

Changing Device Label

A device label to identify the Web Presenter can be changed by sending an identity block with label key.

```
IDENTITY:↵
Label: My Web Presenter↵
↵
ACK↵
↵
IDENTITY:↵
Label: My Web Presenter↵
↵
```

Version Block

The version block contains hardware and software version information for the connected Web Presenter.

Block Syntax

```
VERSION:↵  
Product ID: BE73↵  
Hardware Version: 0100↵  
Software Version: 0123ABCD↵  
Software Release: 3.3↵  
↵
```

Parameters

Key	Read/Write	Description	Valid Values
Product ID	Read only	The Web Presenter product ID	Hexadecimal ID
Hardware Version	Read only	The Web Presenter hardware version	Hexadecimal version
Software Version	Read only	The Web Presenter software version	Hexadecimal version
Software Release	Read only	The Web Presenter software release version	Version Number

Network Blocks

The network block contains the TCP/IP networking configuration for the connected Web Presenter.

Block Syntax

This example shows the output for a connected Web Presenter. It displays 2 networking interfaces - the Gigabit Ethernet interface and option for a tethered smartphone.

The network settings prefixed with Current show the active TCP/IP settings, and are read-only. The Current settings reflect either the DHCP or Static configuration, depending on the Dynamic IP flag.

```
NETWORK:↵  
Interface Count: 2↵  
Default Interface: 0↵  
↵  
NETWORK INTERFACE 0:↵  
Name: Ethernet↵  
Priority: 1↵  
MAC Address: 00:11:22:33:44:55↵  
Dynamic IP: true↵  
Current Addresses: 192.168.1.10/255.255.255.0↵  
Current Gateway: 192.168.1.1↵  
Current DNS Servers: 192.168.1.1, 8.8.8.8, 8.8.4.4↵  
Static Addresses: 10.0.0.2/255.255.255.0↵  
Static Gateway: 10.0.0.1↵  
Static DNS Servers: 8.8.8.8, 8.8.4.4↵  
↵
```

```

NETWORK INTERFACE 1:↵
Name: USBEthernet↵
Priority: 0↵
MAC Address: 00:00:00:00:00:00↵
Dynamic IP: true↵
Current Addresses: 0.0.0.0/255.255.0.0↵
Current Gateway: 0.0.0.0↵
Current DNS Servers: ↵
Static Addresses: 10.0.0.2/255.255.255.0↵
Static Gateway: 10.0.0.1↵
Static DNS Servers: 8.8.8.8, 8.8.4.4↵
↵

```

Parameters

Network Block

Key	Read/Write	Description	Valid Values
Interface Count	Read only	The number of networking interfaces supported by the Web Presenter	Integer
Default Interface	Read only	The default networking interface	Integer

Network Interface Block

Key	Read/Write	Description	Valid Values
Name	Read only	The name of the networking interface	String
Priority	Read/Write	The priority of the network interface. When multiple network interfaces are available, the high priority interface will become the default	Unsigned integer. The higher number is the higher priority
MAC Address	Read Only	MAC address of the networking interface	IEEE 802 MAC address
Dynamic IP	Read/Write	Selects DHCP or Static IP configuration	true - DHCP enabled false - Static IP
Current Addresses	Read Only	The current IP address and Subnet mask	{IPv4 address}/{Subnet Mask}
Current Gateway	Read Only	The current IP gateway address	IPv4 address
Current DNS Servers	Read only	The IP addresses of the current DNS servers	Comma separated list of IPv4 addresses
Static Addresses	Read/Write	Status IP address and subnet mask when DHCP disabled	{IPv4 address}/{Subnet Mask}
Static Gateway	Read/Write	Static gateway address when DHCP disabled	IPv4 address
Static DNS Servers	Read/Write	The IP addresses of the static DNS servers	Comma separated list of IPv4 addresses

Changing Networking Settings

The network can be configured to use either DHCP or a static configuration. To enable DHCP on Network Interface 0:

```
NETWORK INTERFACE 0:↵
```

```
Dynamic IP: true↵
```

```
↵
```

```
ACK↵
```

```
↵
```

```
NETWORK INTERFACE 0:↵
```

```
Dynamic IP: true↵
```

```
↵
```

To set a fixed IP address, supply all static parameters:

```
NETWORK INTERFACE 0:↵
```

```
Dynamic IP: false↵
```

```
Static Addresses: 192.168.1.2/255.255.255.0↵
```

```
Static Gateway: 192.168.1.1↵
```

```
Static DNS Servers: 8.8.8.8, 8.8.4.4↵
```

```
↵
```

```
ACK↵
```

```
↵
```

```
NETWORK INTERFACE 0:↵
```

```
Dynamic IP: false↵
```

```
Static Addresses: 192.168.1.2/255.255.255.0↵
```

```
Static Gateway: 192.168.1.1↵
```

```
Static DNS Servers: 8.8.8.8, 8.8.4.4↵
```

```
↵
```

Changing network settings may cause the IP connection to be dropped.

UI Settings Block

The UI settings block contains the front panel LCD and monitor output settings for the connected Web Presenter.

Block Syntax

```
UI SETTINGS:↵
```

```
Available Locales: en_US.UTF-8, zh_CN.UTF-8, ja_JP.UTF-8, ko_KR.UTF-8, es_
ES.UTF-8, de_DE.UTF-8, fr_FR.UTF-8, ru_RU.UTF-8, it_IT.UTF-8, pt_BR.UTF-8,
tr_TR.UTF-8, pl_PL.UTF-8, uk_UA.UTF-8↵
```

```
Current Locale: en_US.UTF-8↵
```

```
Available Audio Meters: PPM -18dB, PPM -20dB, VU -18dB, VU -20dB↵
```

```
Current Audio Meter: PPM -20dB↵
```

```
↵
```

Parameters

Key	Read/Write	Description	Valid Values
Available Locales	Read only	The locales available in the Web Presenter	Comma separated list of locales
Current Locale	Read/Write	The current locale for Web Presenter	Refer to the locales from the Available Locales field
Available Audio Meters	Read only	The available audio meters supported by the Web Presenter	Comma separated list of audio meter types
Current Audio Meter	Read/Write	The current audio meter	Refer to the audio meters from the Available Audio Meters field

Stream Settings Block

The stream settings block contains the stream configuration for the connected Web Presenter.

Block syntax

This example shows the output for a connected Web Presenter. The stream settings prefixed with Current show the active stream settings and are writable. The stream settings prefixed by Available show the available stream settings for the device or platform and are read-only. To view the available servers or quality levels for a stream service, the Current Platform stream setting should be set first.

```
STREAM SETTINGS:↵
Available Video Modes: Auto, 1080p23.98, 1080p24, 1080p25, 1080p29.97,
1080p30, 1080p50, 1080p59.94, 1080p60, 720p25, 720p30, 720p50, 720p60↵
Video Mode: 1080p59.94↵
Current Platform: YouTube↵
Current Server: Primary↵
Current Quality Level: Streaming Medium↵
Stream Key: abc1-def2-ghi3-jkl4-mno5↵
Password: ↵
Current URL: srt://192.168.8.51
Customizable URL: true
Available Default Platforms: YouTube RTMP, YouTube SRT (Beta), Facebook,
Twitch, Twitter, Restream.IO, Vimeo, BoxCast, CastR, AfreecaTV, Bilibili,
DouYu, Weibo↵
Available Custom Platforms: My Platform↵
Available Servers: Primary, Secondary↵
Available Quality Levels: HyperDeck High, HyperDeck Medium, HyperDeck Low,
Streaming High, Streaming Medium, Streaming Low↵
↵
```

Parameters

Key	Read/Write	Description	Valid Values
Available Video Modes	Read only	The video modes available in the Web Presenter	Comma separated list of video modes
Video Mode	Read/Write	The current video mode	Refer to the video modes from the <i>Available Video Modes</i> field
Current Platform	Read/Write	The selected streaming platform	Refer to the platforms from the <i>Available Default Platforms</i> and <i>Available Custom Platforms</i> fields
Current Server	Read/Write	The current server for the streaming platform	Server is dependent on selected Current Platform
Current Quality Level	Read/Write	The current streaming quality level	Quality level is dependent on selected Current Platform
Stream Key	Read/Write	The stream key for the streaming platform	String
Password	Read/Write	The passphrase for an encrypted SRT stream	String
Current URL	Read/Write	The current URL for the streaming platform. This field is writable if <i>Customizable URL</i> field is true.	String
Customizable URL	Read only	A boolean specifying whether custom URLs are supported by the streaming platform	true - Custom URLs are supported false - Custom URLs are not supported
Available Default Platforms	Read only	The available default streaming platforms	Comma separated list of default platforms
Available Custom Platforms	Read only	The custom streaming platforms loaded in the Web Presenter	Comma separated list of custom platforms
Available Servers	Read only	The available servers for the selected streaming platform	Comma separated list of servers
Available Quality Levels	Read only	The available quality levels for the selected streaming platform	Comma separated list of quality levels

Changing Stream Settings

The stream settings can be changed by providing a stream settings block. The following is an example of streaming a 1080p59.94 input on Twitch with a medium stream quality.

```

STREAM SETTINGS:↵
Video Mode: 1080p59.94↵
Current Platform: Twitch↵
Current Server: US West: Los Angeles, CA↵
Current Quality Level: Streaming Medium↵
Stream Key: live_123456789_1aB2cD3eF4gH5iJ6kL7mN8oP9qR0sT↵
↵
ACK↵
↵
STREAM SETTINGS:↵
Video Mode: 1080p59.94↵
Current Platform: Twitch↵
Current Server: US West: Los Angeles, CA↵
Current Quality Level: Streaming Medium↵
Stream Key: live_123456789_1aB2cD3eF4gH5iJ6kL7mN8oP9qR0sT↵
↵

```

Stream XML Block

The stream XML block allows users to configure the Web Presenter with a custom configuration file in XML format.

Block syntax

The following example shows an XML file - Custom.xml has been loaded to configure the stream settings in the Web Presenter.

```
STREAM XML:↵  
Files: Custom.xml↵  
↵
```

Parameters

Key	Read/Write	Description	Valid Values
Files	Read/Write	The XML files loaded in Web Presenter	Comma separated list of filenames
Action	Write only	The stream XML action	Remove Remove All

Adding a Stream XML file

An XML file can be loaded onto a Web Presenter by sending the stream xml command with a filename, then provide the contents of the XML file. After adding the XML file, the Available Custom Platforms field in the STREAM SETTINGS block will be updated with the new platforms, however the Current items will remain unchanged.

For the Stream XML block to be parsed correctly, any blank lines should be removed from the XML files.

Refer to the `Blackmagic Stream XML File Format` section in this manual for description of the Stream XML file format.

```
STREAM XML Custom.xml:↵  
<?xml version="1.0" encoding="UTF-8"?>↵  
<streaming>↵  
    <service>↵  
        <name>My Custom Platform</name>↵  
        ...  
    </service>↵  
</streaming>↵  
↵  
ACK↵  
↵  
STREAM XML Custom.xml:↵  
<?xml version="1.0" encoding="UTF-8"?>↵  
<streaming>↵  
    <service>↵  
        <name>My Custom Platform</name>↵  
        ...  
    </service>↵  
</streaming>↵  
↵
```

```
STREAM XML:↵
Files: Custom.xml↵
↵
STREAM SETTINGS:↵
Available Custom Platforms: My Custom Platform↵
↵
```

Removing a Stream XML file

An XML file can be removed from the Web Presenter by sending the stream xml command with the remove action.

```
STREAM XML:↵
Action: Remove↵
Files: Custom.xml↵
↵
ACK↵
↵
STREAM XML:↵
Files:↵
↵
STREAM SETTINGS:↵
Available Custom Platforms:↵
↵
```

Removing all Stream XML files

All XML files can be removed from the Web Presenter by sending the stream xml command with the remove all action. In the example, following the remove all action, the loaded stream XML files and available custom platforms are both displayed as empty.

```
STREAM XML:↵
Action: Remove All↵
↵
ACK↵
↵
STREAM XML:↵
Files: ↵
↵
STREAM SETTINGS:↵
Available Custom Platforms:↵
↵
```

Stream State Block

The stream state block provides the streaming status of the Web Presenter.

The Web Presenter server will send a stream state block update whenever there is a change to the Status field. Due to frequency of changes to Duration, Bitrate and Cache Used fields, these fields need to be polled by the client by requesting a Stream State block.

Block syntax

```
STREAM STATE:↵↵
Status: Idle↵↵
Bitrate: 161672↵↵
Duration: 00:00:00:00↵↵
Cache Used: 0↵↵
↵↵
```

Parameters

Key	Read/Write	Description	Valid Values
Status	Read only	The stream state of the Web Presenter, updated when the stream status changes	Idle Connecting Streaming Interrupted
Action	Write only	The Web Presenter stream state action.	Start Stop
Duration	Read only	The duration of the active stream	String in format of DD:HH:MM:SS
Bitrate	Read only	The bitrate of the active stream	Integer bits per second
Cache Used	Read only	The current usage of the streaming cache	Integer as a percentage

Starting Stream

The stream is started by providing a stream state block with start action.

```
STREAM STATE:↵↵
Action: Start↵↵
↵↵
ACK↵↵
↵↵
STREAM STATE:↵↵
Status: Connecting↵↵
↵↵
STREAM STATE:↵↵
Status: Streaming↵↵
↵↵
```

Stopping stream

The stream is stopped by providing a Stream State block with stop action.

```
STREAM STATE:↵↵
Action: Stop↵
↵
ACK↵
↵
STREAM STATE:↵↵
Status: Idle↵
↵
```

Audio Settings Block

The Audio Settings block contains the audio configuration for the connected Web Presenter.

Block syntax

This example shows the output for a connected Web Presenter. The stream settings prefixed with Current show the active audio settings and are writable. The stream settings prefixed by Available show the available audio settings for the device or platform and are read-only.

```
AUDIO SETTINGS:↵↵
Current Monitor Out Audio Source: Auto↵
Available Monitor Out Audio Sources: Auto, SDI In, Remote Source↵
↵
```

Parameters

Key	Read/Write	Description	Valid Values
Current Monitor Out Audio Source	Read/Write	The current audio source on the monitor output	Refer to the audio sources from the <i>Available Monitor Out Audio Sources</i> field
Available Monitor Out Audio Sources	Read only	The available audio sources that can be routed to the monitor output	Comma separated list of audio sources

Changing Audio Settings

The audio settings can be changed by providing an audio settings block. The following is an example of setting the monitor output audio source to remote.

```
AUDIO SETTINGS:↵↵
Current Monitor Out Audio Source: Remote Source↵
↵
ACK↵
↵
AUDIO SETTINGS:↵↵
Current Monitor Out Audio Source: Remote Source↵
↵
```

Shutdown Block

The Shutdown block provides power control of the Web Presenter. The Shutdown block is write-only and not presented in the preamble.

Parameters

Key	Read/Write	Description	Valid Values
Action	Write only	The Web Presenter shutdown action.	Reboot Factory Reset

Reboot

The Web Presenter can be rebooted by providing a Shutdown block with reboot action.

```
SHUTDOWN:↵
```

```
Action: Reboot↵
```

```
↵
```

```
ACK↵
```

```
↵
```

On reboot action, the Web Presenter server will be stopped and clients will be disconnected.

Factory Reset

The Web Presenter can be factory reset by providing a Shutdown block with factory reset action. On factory reset action, all settings are set to factory defaults.

```
SHUTDOWN:↵
```

```
Action: Factory Reset↵
```

```
↵
```

```
ACK↵
```

```
↵
```

Blackmagic Streaming XML Format

Overview

The Blackmagic Streaming XML allows users to specify streaming services in addition to the default services provided by the Web Presenter.

The Streaming XML can be loaded into the Web Presenter with Web Presenter Setup. Refer to the 'Using Web Presenter Setup' section earlier in this manual

The Streaming XML can also be loaded by copying the contents into the Stream XML block with the Blackmagic Web Presenter Ethernet Protocol.

The following is a minimal example of a Streaming XML file:

```
<?xml version="1.0" encoding="UTF-8"?>
<streaming>
  <service>
    <name>My Streaming Service</name>
    <servers>
      <server>
        <name>My Streaming Server</name>
        <url>rtmp://my.streaming-server.com/live</url>
      </server>
    </servers>
    <profiles>
      <profile>
        <name>My Streaming Quality</name>
        <config resolution="1080p" fps="60" codec="H264">
          <bitrate>7500000</bitrate>
        </config>
      </profile>
    </profiles>
  </service>
</streaming>
```

Streaming XML Definition

The Streaming XML file follows standard XML format and shall begin with XML declaration.

```
<?xml version="1.0" encoding="UTF-8"?>
```

Streaming Element

The Streaming XML file shall be contained by the <streaming> element. The <streaming> element will consist of 1 or more <service> child elements.

The following is an example of a <streaming> element block that defines 2 streaming services.

```
<streaming>
  <service>
    <name>Service 1</name>
    <!-- Streaming settings for "Service 1" -->
  </service>
  <service>
    <name>Service 2</name>
    <!-- Streaming settings for "Service 2" -->
  </service>
</streaming>
```

Service Element

The <service> element provides a description of the streaming service. If multiple streaming services are used, it is possible to define multiple <service> elements within each <streaming> element block.

The following is an example of a <service> element block in the Stream XML file.

```
<streaming>
  <service customizable-url="true">
    <name>My Streaming Service</name>
    <key>abc1-def2-ghi3-jkl4-mno5</key>
    <servers>
      <!-- Streaming server settings -->
    </servers>
    <profiles default="Streaming High">
      <!-- Streaming quality settings-->
    </profiles>
    <credentials>
      <!-- Streaming username and password settings -->
    </credentials>
  </service>
  <!-- <service> elements blocks for other streaming services -->
</streaming>
```

Attributes

Attribute	Optional/Required	Description
customizable-url	Optional	The service supports specifying custom URLs - supported = "true" or unsupported = "false" (default)

Child Elements

Element	Optional/Required	Description
<name>	Required	The name of the streaming service
<key>	Optional	The stream key for the streaming service
<servers>	Optional	The RTMP/SRT server settings of the streaming service (see below). May be omitted if customizable-url is true.
<profiles>	Required	The quality settings of the streaming service (see below)
<credentials>	Optional	The username and password of the streaming service (see below)

Servers Element

The <servers> element consists of 1 or more <server> child elements for defining the streaming server(s). The <servers> element is a required child of the <service> element. Defining multiple servers allows specifying localized and/or backup servers within a single XML description

The following is an example of a <servers> element block that defines a primary and secondary URL for the SRT server.

```
<service>
  ...
  <servers>
    <server group="Primary">
      <name>My Streaming Service Server</name>
      <url>srt://srt.my-streaming-service.com:2010</url>
      <srt-extensions>
        ...
      </srt-extensions>
    </server>
    <server group="Secondary">
      <name>My Streaming Service Backup Server</name>
      <url>srt://srt-backup.my-streaming-service.com:2010</url>
      <srt-extensions>
        ...
      </srt-extensions>
    </server>
    <!-- Additional <server> element blocks defining other
servers for streaming service -->
  </servers>
  ...
</service>
```

Attributes

Attribute	Optional/Required	Description
group	Optional	The logical grouping for the server

Child Elements

Element	Optional/Required	Description
<name>	Required	The name of the RTMP/SRT streaming server
<url>	Required	The URL of the RTMP/SRT streaming server
<srt-extensions>	Optional	Extended service block specific to SRT streaming server (see below)

SRT Extensions Element

The <srt-extensions> element consists of 1 or more child elements that define SRT specific parameters.

The following is an example of a <srt-extensions> element block for a primary stream identifier.

```
<service>
  ...
  <servers>
    <server group="Primary">
      ...
      <srt-extensions>
        <stream-id>
          <item key="copy" value="0"/>
        </stream-id>
      </srt-extensions>
    </server>
  </servers>
  ...
</service>
```

Child Elements

Element	Optional/Required	Description
<stream-id>	Required	Provides element with custom parameters for the stream ID. Each child element of stream-id has 1 or more item elements with a key/value pair.

Profiles Element

The <profiles> element consists of 1 or more <profile> child elements that define streaming quality. The <profiles> element is a required child of the <service> element. Defining multiple profiles allows specifying custom bitrates for different streaming qualities.

The following is an example of a <profiles> element block that defines 3 profiles.

```
<service>
  ...
  <profiles default="Streaming High">
    <profile>
      <name>Streaming High</name>
      <!-- Define <config> elements to specify target
bitrates for Streaming High profile -->
    </profile>
    <profile>
      <name>Streaming Medium</name>
      <!-- Define <config> elements to specify target
bitrates for Streaming Medium profile -->
    </profile>
  </profiles>
  ...
</service>
```

Attributes

Attribute	Optional/Required	Description
default	Optional	The name of the default profile

Child Elements

Element	Optional/Required	Description
<name>	Required	The name of the profile
<config>	Required	Video mode dependent quality settings for profile (see below)

Config Element

The <config> element defines a mapping between the video resolution and frame rate and the target bitrate for the quality level. The <config> element is a child of the <profile> element.

The following is an example of a <config> element block for setting the target bitrate for a high quality stream with 720p60 and 1080p60 video inputs.

```
<profile>
  <name>Streaming High</name>
  <config resolution="720p" fps="60" codec="H264">
    <bitrate>6000000</bitrate>
    <audio-bitrate>128000</audio-bitrate>
  </config>
  <config resolution="1080p" fps="60" codec="H264">
    <bitrate>8000000</bitrate>
    <audio-bitrate>128000</audio-bitrate>
  </config>
  <!-- <config> elements for other resolutions and frame rates -->
</profile>
```

Attributes

Attribute	Optional/Required	Description
resolution	Required	The resolution of the streaming video mode
fps	Required	The frame rate of the streaming video mode (frames per second)
codec	Optional	The codec for encoding the streaming video - "H264" (default) or "H265"

Child Elements

Element	Optional/Required	Description
<bitrate>	Required	The target bitrate of the streaming video (bits per second)
<audio-bitrate>	Optional	The target bitrate of the streaming audio (bits per second)

The supported streaming quality bitrates can be found in section `Using Web Presenter Setup` section earlier in this manual.

TIP For each <config> element block, choose a maximum resolution and fps to cover all video modes for the target bitrate. For example, defining a <config> element with resolution="1080p" and fps = "30" will apply for video modes 1080p23.98, 1080p24, 1080p25, 1080p29.97 and 1080p30.

For audio bitrate, only 128 Kb/s is supported.

Credentials Element

The <credentials> element allows specifying an RTMP session username and password if required by the service. The <credentials> element is an optional child to service element.

The following is an example of a <credentials> element block that defines a username and password for the streaming service.

```
<service>
  ...
  <credentials>
    <username>myusername</username>
    <password>abcd1234</password>
  </credentials>
  ...
</service>
```

Child Elements

Element	Optional/Required	Description
<username>	Required	RTMP session username
<password>	Required	RTMP/SRT session password

Help

Getting Help

The fastest way to obtain help is to go to the Blackmagic Design online support pages and check the latest support material available for your Blackmagic Web Presenter.

Blackmagic Design Online Support Pages

The latest manual can be found at the Blackmagic Design support center at www.blackmagicdesign.com/support

Blackmagic Design Forum

The Blackmagic Design forum on our website is a helpful resource you can visit for more information and creative ideas. This can also be a faster way of getting help as there may already be answers you can find from other experienced users and Blackmagic Design staff which will keep you moving forward. You can visit the forum at <https://forum.blackmagicdesign.com>

Contacting Blackmagic Design Support

If you can't find the help you need in our support material or on the forum, please use the 'send us an email' button on the support page to email a support request. Alternatively, click on the 'find your local support team' button on the support page and call your nearest Blackmagic Design support office.

Regulatory Notices



Disposal of waste of electrical and electronic equipment within the European union.

The symbol on the product indicates that this equipment must not be disposed of with other waste materials. In order to dispose of your waste equipment, it must be handed over to a designated collection point for recycling. The separate collection and recycling of your waste equipment at the time of disposal will help conserve natural resources and ensure that it is recycled in a manner that protects human health and the environment. For more information about where you can drop off your waste equipment for recycling, please contact your local city recycling office or the dealer from whom you purchased the product.



This equipment has been tested and found to comply with the limits for a Class A digital device, pursuant to Part 15 of the FCC rules. These limits are designed to provide reasonable protection against harmful interference when the equipment is operated in a commercial environment. This equipment generates, uses, and can radiate radio frequency energy and, if not installed and used in accordance with the instructions, may cause harmful interference to radio communications. Operation of this product in a residential area is likely to cause harmful interference, in which case the user will be required to correct the interference at personal expense.

Operation is subject to the following two conditions:

- 1 This device may not cause harmful interference.
- 2 This device must accept any interference received, including interference that may cause undesired operation.



R-R-BMD-20201201001
R-R-BMD-20201201002

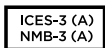

ISED Canada Statement

This device complies with Canadian standards for Class A digital apparatus.

Any modifications or use of this product outside its intended use could void compliance to these standards.

Connection to HDMI interfaces must be made with high quality shielded HDMI cables.

This equipment has been tested for compliance with the intended use in a commercial environment. If the equipment is used in a domestic environment, it may cause radio interference.

Safety Information

This equipment must be connected to a mains socket outlet with a protective earth connection.

To reduce the risk of electric shock, do not expose this equipment to dripping or splashing.

This equipment is suitable for use in tropical locations with an ambient temperature of up to 40°C.

Storage temperature range is -20°C to 60°C and relative humidity 0% to 90% non-condensing.

Ensure that adequate ventilation is provided around the product and is not restricted.

When rack mounting, ensure the ventilation is not restricted by adjacent equipment.

No operator serviceable parts inside. Refer servicing to your local Blackmagic Design service centre.



Use only at altitudes not more than 2000m above sea level.

State of California statement

This product can expose you to chemicals such as trace amounts of polybrominated biphenyls within plastic parts, which is known to the state of California to cause cancer and birth defects or other reproductive harm.

For more information go to www.P65Warnings.ca.gov.

Warranty

36 Month Limited Warranty

Blackmagic Design warrants that Blackmagic Web Presenter will be free from defects in materials and workmanship for a period of 36 months from the date of purchase excluding connectors, cables, fiber optic modules, fuses and batteries which will be free from defects in materials and workmanship for a period of 12 months from the date of purchase. If the product proves to be defective during this warranty period, Blackmagic Design, at its option, either will repair the defective product without charge for parts and labor, or will provide a replacement in exchange for the defective product.

In order to obtain service under this warranty, you the Customer, must notify Blackmagic Design of the defect before the expiration of the warranty period and make suitable arrangements for the performance of service. The Customer shall be responsible for packaging and shipping the defective product to a designated service center nominated by Blackmagic Design, with shipping charges pre paid. Customer shall be responsible for paying all shipping charges, insurance, duties, taxes, and any other charges for products returned to us for any reason.

This warranty shall not apply to any defect, failure or damage caused by improper use or improper or inadequate maintenance and care. Blackmagic Design shall not be obligated to furnish service under this warranty: a) to repair damage resulting from attempts by personnel other than Blackmagic Design representatives to install, repair or service the product, b) to repair damage resulting from improper use or connection to incompatible equipment, c) to repair any damage or malfunction caused by the use of non Blackmagic Design parts or supplies, or d) to service a product that has been modified or integrated with other products when the effect of such a modification or integration increases the time or difficulty of servicing the product. THIS WARRANTY IS GIVEN BY BLACKMAGIC DESIGN IN LIEU OF ANY OTHER WARRANTIES, EXPRESS OR IMPLIED. BLACKMAGIC DESIGN AND ITS VENDORS DISCLAIM ANY IMPLIED WARRANTIES OF MERCHANTABILITY OR FITNESS FOR A PARTICULAR PURPOSE. BLACKMAGIC DESIGN'S RESPONSIBILITY TO REPAIR OR REPLACE DEFECTIVE PRODUCTS IS THE WHOLE AND EXCLUSIVE REMEDY PROVIDED TO THE CUSTOMER FOR ANY INDIRECT, SPECIAL, INCIDENTAL OR CONSEQUENTIAL DAMAGES IRRESPECTIVE OF WHETHER BLACKMAGIC DESIGN OR THE VENDOR HAS ADVANCE NOTICE OF THE POSSIBILITY OF SUCH DAMAGES. BLACKMAGIC DESIGN IS NOT LIABLE FOR ANY ILLEGAL USE OF EQUIPMENT BY CUSTOMER. BLACKMAGIC IS NOT LIABLE FOR ANY DAMAGES RESULTING FROM USE OF THIS PRODUCT. USER OPERATES THIS PRODUCT AT OWN RISK.

© Copyright 2023 Blackmagic Design. All rights reserved. 'Blackmagic Design', 'DeckLink', 'HDLINK', 'Workgroup Videohub', 'Multibridge Pro', 'Multibridge Extreme', 'Intensity' and 'Leading the creative video revolution' are registered trademarks in the US and other countries. All other company and product names may be trade marks of their respective companies with which they are associated.

Thunderbolt and the Thunderbolt logo are trademarks of Intel Corporation in the U.S. and/or other countries.

Blackmagic Web Presenter





ようこそ

このたびはBlackmagic Web Presenterをお買い求めいただき誠にありがとうございました。

Blackmagic Web Presenterは、あらゆるSDI機器に直接接続でき、信号をH.264に変換し、YouTube Live、Facebook Live、Twitchなどの人気の配信サービスでビデオを配信できます。また、ATEM Streaming Bridgeを使用することで、放送品質のビデオを2地点間で発信できます。これにより、インターネットを使用して、プロフェッショナルなビデオを離れた場所に簡単に送信できます。

このマニュアルには、Blackmagic Web Presenterを使用する上で必要な情報がすべて記載されています。また、YouTube Live、Facebook Live、Twitch、Zoom、Skypeなどを使用するためのセットアップ方法など、あらゆる機能とコントロールの使用方法も説明しています。

弊社ウェブサイト www.blackmagicdesign.com/jp のサポートページで、このマニュアルの最新バージョン、およびBlackmagic Web Presenterの内部ソフトウェアのアップデートを確認できます。ソフトウェアをダウンロードする際にユーザー登録していただければ、新しいソフトウェアのリリース時にお知らせいたします。

常に新機能の開発および製品の改善に努めていますので、ユーザーの皆様からご意見をいただければ幸いです。

A cursive signature in black ink that reads "Grant Petty". The signature is fluid and stylized, with the first letters of "Grant" and "Petty" being larger and more prominent.

Blackmagic Design CEO

グラント・ペティ

目次

はじめに	58
Web Presenterのフロントパネルの使用方法	61
LCDディスプレイ	62
モニター出力の使用	63
Web Presenter Setupの使用	68
Live Stream (ライブ配信) タブ	69
Setup (セットアップ) タブ	72
ネットワーク設定	73
直接配信のためにインターネットの共有を設定する	73
スマートフォンを使用した配信	74
Blackmagic Web Presenter HDをウェブカメラとして使用する	74
Open Broadcasterのセットアップ	74
ATEM Streaming Bridgeでビデオリンクを構築	77
XMLファイルの作成	78
XMLファイルの書き出し	78
タリー、トークバック、カメラコントロール	79
URSA Broadcast G2の接続	80
Blackmagic Universal Rack Shelf	81
同梱物	81
Universal Rack Shelfにユニットをマウントする	82
1/6ラック幅ブランクパネルの取り付け	82
1/3ラック幅ブランクパネルの取り付け	82
内部ソフトウェアのアップデート	83
Developer Information	84
Blackmagic Web Presenter Ethernet Protocol	84
Protocol Blocks	86
Blackmagic Streaming XML Format	97
Overview	97
Streaming XML Definition	97
ヘルプ	104
規制に関する警告	105
安全情報	106
保証	107

はじめに

Blackmagic Web Presenterは簡単に使い始められます! 必要な作業は、電源につなぎ、ビデオおよびオーディオを接続し、コンピューターにユニットを接続し、その後インターネットに接続するだけです。

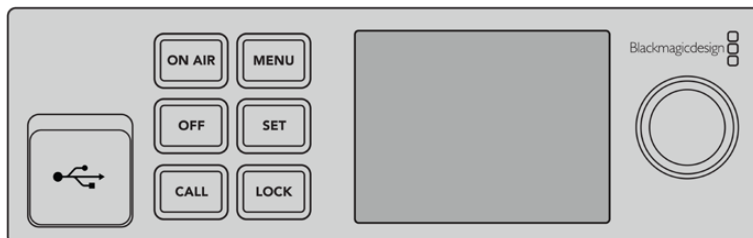

Blackmagic Web Presenterのフロントパネル

電源の接続

Blackmagic Web Presenterのリアパネルの電源入力に標準IEC電源ケーブルを接続します。

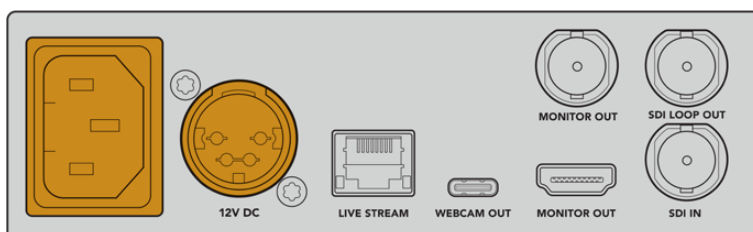

Blackmagic Web Presenterは、IECまたは12V DC電源入力から給電可能

Web Presenterには、12V DC電源入力も搭載されています。外部電源を接続したい場合、あるいは外部電源（連続電力供給可能なUPSや外付け12Vバッテリーなど）からのリダンダント電源を接続したい場合は、この12V DC入力を使用できます。

ビデオとオーディオを接続

ビデオソースをBlackmagic Web PresenterのSDI入力に接続 ビデオが接続されると、Web Presenterの内蔵LCDに表示されます。オーディオは、SDIビデオ信号でビデオにエンベッドされます。これは、LCDのオーディオメーターで確認できます。

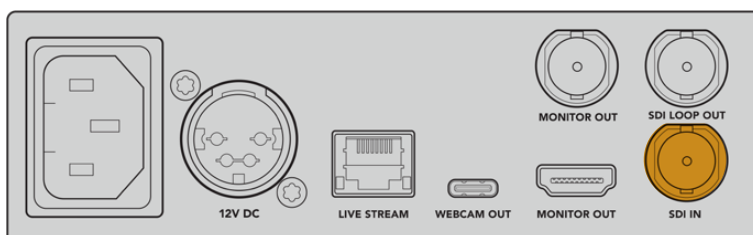

ビデオをBlackmagic Web PresenterのSDI入力に接続

Blackmagic Web Presenterは12G-SDIに対応しており、ビデオ入力が変わった場合に、HDとUltra HD（最大2160p60まで）を自動的に切り替えます。Blackmagic Web Presenter 4KはUltra HDを配信でき、Blackmagic Web Presenter HDでは事実上あらゆるビデオ信号を1080pに変換できます。

モニターを接続

HDMIテレビまたはSDIモニターをモニター出力のひとつに接続します。これにより、放送をモニタリングでき、重要なステータス情報も確認できます。ステータスは、ビデオストリームと共に表示され、常に更新されます。モニター出力の使用の詳細は、「モニター出力の使用」セクションを参照してください。

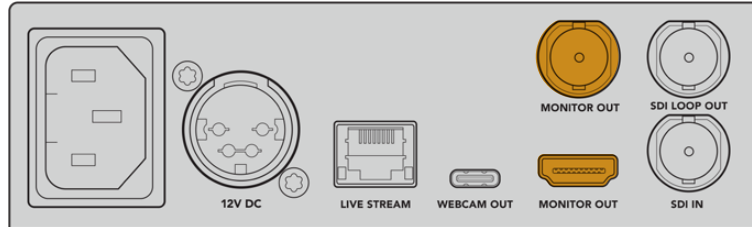

Web Presenterのモニター出力にモニターを接続

USB経由でコンピューターを接続

Web PresenterのフロントパネルまたはリアパネルのUSBポートを使用して、コンピューターに接続します。これらのUSBポートは、ユニットのアップデートとBlackmagic Web Presenter Setup Utilityでのコンフィギュレーションに使用します。Web Presenterの最初のコンフィギュレーションを行ったら、コンピューターとユニットの接続を外せます。

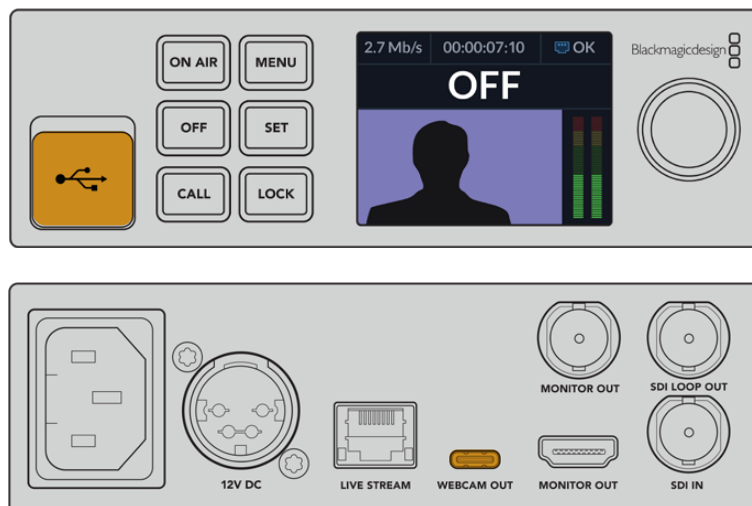

Blackmagic Web PresenterのフロントパネルまたはリアパネルのUSBポートを使用してコンピューターに接続

インターネットに接続

Blackmagic Web Presenterの「LIVE STREAM」というラベルが付いたイーサネットポートに繋いだネットワークケーブルを、インターネットルーターまたはネットワークスイッチと接続し、インターネットに接続します。

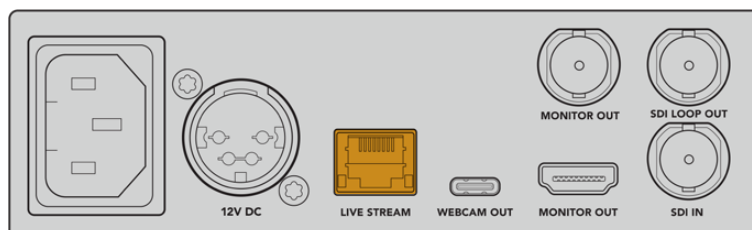

Blackmagic Web Presenterをリアパネルのイーサネットポートでネットワークに接続

ライブ配信のセットアップ

次は、Web Presenterをセットアップして、YouTube Live、Facebook Live、Twitchなどの配信プラットフォームを介して配信できます。この例では、YouTube Liveでの配信のセットアップを行います。

- 1 YouTube Studioのアカウントからストリームキーをコピーします。
- 2 Blackmagic Web Presenter Setup Utilityをwww.blackmagicdesign.com/jp/supportからダウンロードし、コンピューターにインストールします。このソフトウェアで、最初の配信設定をコンフィギュレーションできます。
- 3 Blackmagic Web Presenter Setup Utilityを立ち上げ、「Live Stream (ライブ配信)」ページに進みます。
- 4 プラットフォームをYouTube、サーバーを「Primary (プライマリー)」に設定します。YouTubeのストリームキーをコピーし、「Key (キー)」フィールドにペーストして、配信品質を選択します。「Save」をクリックします。
- 5 これで、世界に向けて配信する準備が整いました！「ON AIR」ボタンをクリックするか、フロントパネルの「ON AIR」ボタンを押します。放送が終了したら、「OFF」ボタンを押すと配信を停止できます。

SRT配信プロトコルの使用

SRT (Secure Reliable Transport) では、RTMPと比較して、低遅延の配信が行えます。また、SRTは暗号鍵に似たパスフレーズを使用するので安全性が高いのが特徴です。

配信サービスのSRTプロトコルのバージョンを選択する際は、配信サービスのアカウントからパスフレーズおよびストリームキーをコピーし、Blackmagic Web Presenter Setup Utilityの「Passphrase (パスフレーズ)」と「Key (キー)」フィールドにペーストします。

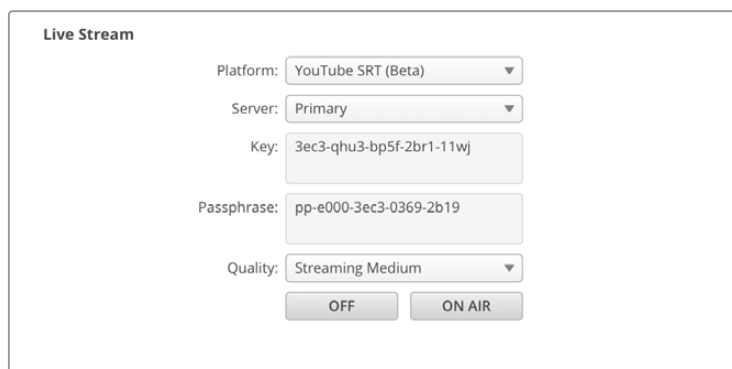

The screenshot shows a window titled "Live Stream" with the following fields and buttons:

- Platform: YouTube SRT (Beta) (dropdown menu)
- Server: Primary (dropdown menu)
- Key: 3ec3-qhu3-bp5f-2br1-11wj (text input)
- Passphrase: pp-e000-3ec3-0369-2b19 (text input)
- Quality: Streaming Medium (dropdown menu)
- Buttons: OFF and ON AIR

Setup Utilityの「Passphrase」フィールドにパスフレーズをペースト

技術的な知識が豊富なスタッフが配信設定をカスタマイズしたい場合、XMLファイルでプロトコルをRTMPまたはSRT、コーデックをH.264またはH.265に変更することが可能です。詳細は「Blackmagic Streaming XML Format」セクションを参照してください。

Web Presenterのフロントパネルの使用方法

Blackmagic Web Presenterのフロントパネルコントロールを使用して、配信の開始と停止や設定の変更を行えます。

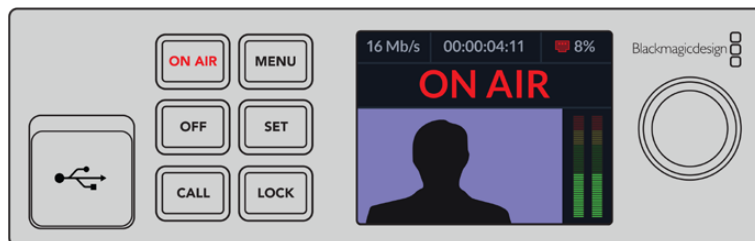

ON AIR – 「ON AIR」 ボタンを押すと配信を開始できます。オンエア中はボタンが赤に点灯します。



「ON AIR」ボタンが点滅している場合、ライブ配信の開始に失敗したか、予期せずライブ配信が停止したことを意味します。これは、インターネット接続または配信設定が原因となっている可能性があります。インターネット接続が機能しているか、配信設定が適切か確認してください。

OFF – 「OFF」 ボタンを押すと配信を停止できます。

MENU – 「MENU」 ボタンを押してLCDの設定を開きます。

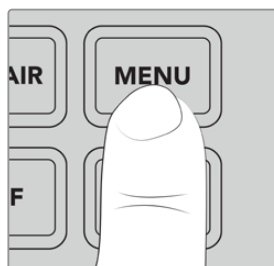

設定を変更する：

- 1 ノブを回転させて、変更したい設定を選択し、「SET」 ボタンを押します。



- 2 ノブを回して、設定を変更します。
- 3 「SET」を押して変更を確定します。

メニューを遡ってホームスクリーンに戻るには「MENU」ボタンを使用します。

CALL – この機能は、将来的なアップデートで使用可能になる予定です。

LOCK – パネルをロックするには、このボタンを1秒間長押しします。これにより、ボタンが使用できなくなるため、誤ってオンエアになったり、配信が止まることを防ぎます。アクティブになっている場合は、ボタンが赤に点灯します。

パネルのロックを解除するには、2秒間長押しします。

LCDディスプレイ

ホームスクリーンは、Web Presenterを起動した際に最初に表示される画面です。ホームスクリーンには以下の情報が表示されます：

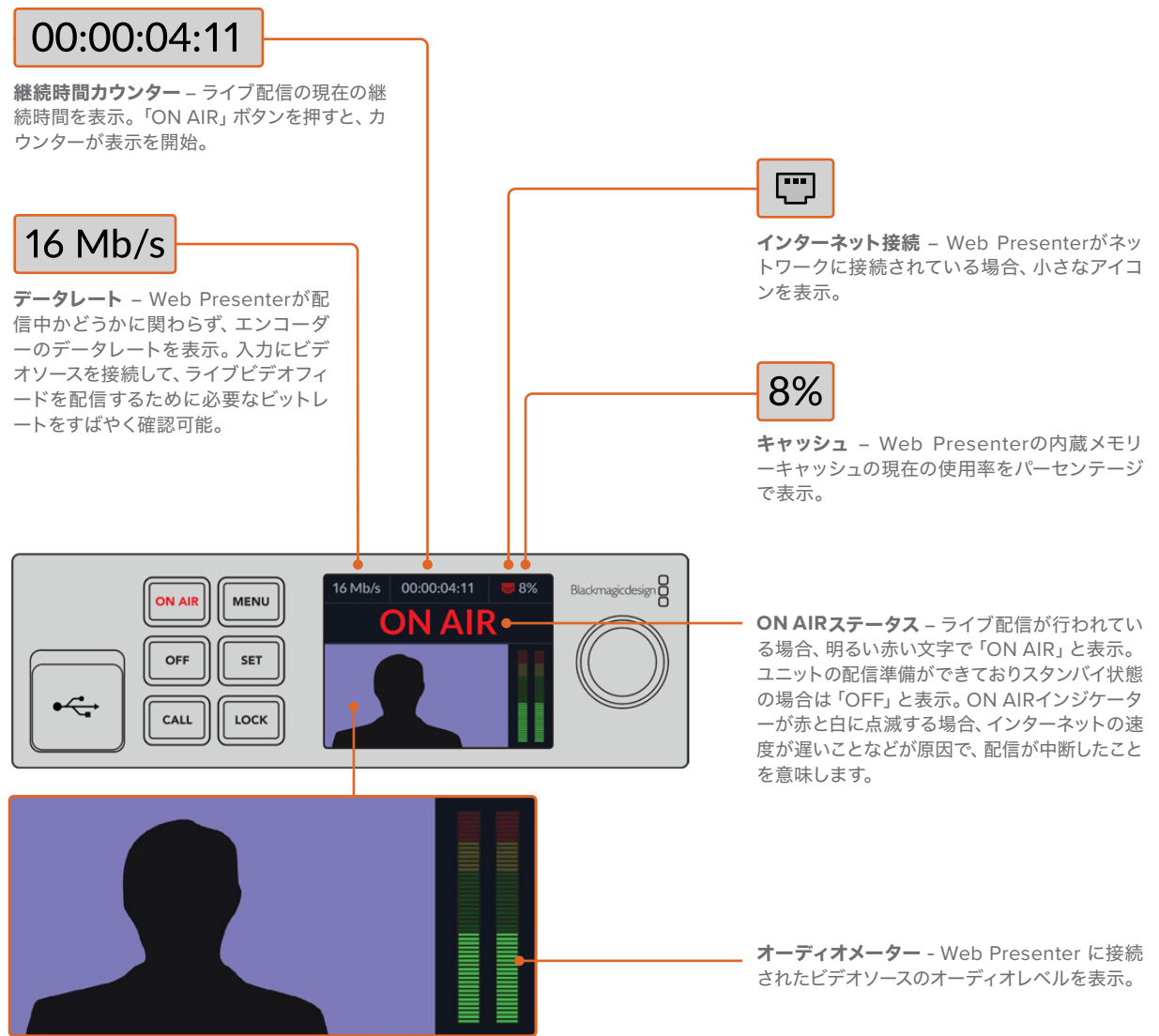

ビデオモニター – Web Presenterに接続された入力ビデオソースを表示。

インターネット接続アイコン



青のイーサネットアイコンは、イーサネットケーブルが接続されており、イーサネット接続での配信準備ができている場合に表示されます。



赤のイーサネットアイコンは、オンエア中で、イーサネット経由で配信されている場合に表示されます。



青のスマートフォンアイコンは、テザリングしているスマートフォンのインターネット接続が配信に使用される準備ができている場合に表示されます。



赤のスマートフォンアイコンは、オンエア中で、テザリングしているスマートフォンを介して配信されている場合に表示されます。

作業のこつ アイコンが表示されない場合、Web Presenterがネットワークに接続されていません。

モニター出力の使用

モニター出力は、ビデオ入力、オーディオレベル、オンエア・ステータス、データレートおよびキャッシュレベル、SDI入力の技術情報などをモニタリングできます。



Blackmagic Web Presenterのモニター出力は、データレートおよびキャッシュステータスなどの総合的な情報を表示

モニター出力の表示画面は8つのパネルで構成されています。以下は各パネルの説明とそれぞれに表示される情報です。

入力ビュー

メインパネルは、接続されているSDIビデオソースからの現在のビデオ入力を表示します。



オンエア・ステータス

配信が行われていない状態では、インジケータは「OFF」と表示し、Web Presenterが放送する準備ができていて、スタンバイ状態であることを示します。配信が始まると、インジケータは明るい赤で「ON AIR」と表示され、配信が停止されると表示が変わります。



ON AIRインジケータの下は、継続時間カウンターです。Web Presenterで「ON AIR」ボタンを押すと、継続時間カウンターがスタートします。

Web Presenterがオフエアで、携帯電話でテザリングして配信される予定の場合、「OFF」の文字の横に青のスマートフォンアイコンが表示されます。オンエア中は、スマートフォンのアイコンは赤に点灯します。

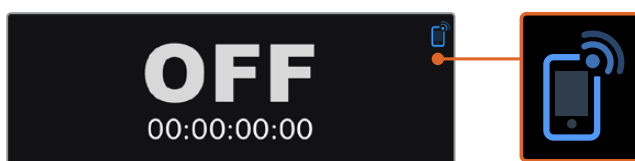

ライブ配信

ライブ配信パネルには、ライブ配信の設定に関する情報が表示されます。これには、配信プラットフォーム、サーバー、プロトコルが含まれます。また、配信の解像度および品質設定も表示します。

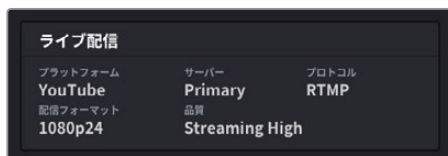

ビデオ入力

ビデオ入力パネル上部に表示される5つのミニビューアは、ライブ配信の過去6秒を表示します。各ミニビューアは1.2秒の配信時間を表します。



ミニビューアの下では、Web PresenterのSDI入力に接続されたビデオ入力ソースに関する技術情報の詳細が確認できます。

入力フォーマット	SDIビデオ入力の解像度とフレームレートを表示します。Web Presenterは2160p60まで対応しています。
カラリメトリ	SDIビデオ入力のカラースペースを表示します。Web Presenterは、Rec.601、Rec.709、Rec.2020カラースペースをサポートしています。
SDI補助データ	補助データは、SDIビデオ入力にビデオに加えて送信されるデータです。これには、エンベデッドオーディオ、タイムコード、クローズドキャプションが含まれます。SDI入力に補助データが含まれている場合、「あり」と表示されます。
タイムコード	SDIビデオ入力ソースからのタイムコードを表示します。
クローズドキャプション	SDIビデオ入力にクローズドキャプションが含まれる場合、フォーマットが表示されます。CEA-608およびCEA-708フォーマットがサポートされています。
SMPTE 292 CR	SDIビデオに対するエラーチェック機能です。Web PresenterがSDIビデオ入力の問題を検出すると、エラーを表示します。CRCエラーは、通常、SDIケーブルに問題がある場合やケーブルが長過ぎる場合に生じます。
輝度Yビットおよびクロマビット	<p>「輝度Yビット」および「クロマビット」のインジケータは、SDIビデオ入力信号のアクティビティを表示します。各文字は、ビデオ信号の1ビットの状態を表します。</p> <p>X – 「X」は、絶えず変化するビットを意味します。</p> <p>L – 低ビット</p> <p>H – 高ビット</p> <p>理解しやすいように、SDIオフセットは取り除かれています。例えば、ビデオがブラックの場合、すべてのビットが低くなります。</p> <p>通常、SDIビデオ入力の全10ビットはXで表示されます。これは、ビデオストリームのすべてのビットが常に変化していることを意味します。SDI入力が8ビットのビデオである場合、右端2桁のビットにはデータが存在しないため、常に「L」と表示されます。ビットが「X」であるべきなのに、「L」や「H」として表示され続ける場合、「変化のないビット」であることを意味し、アップストリームビデオに問題がある可能性があります。</p>

オーディオ入力

オーディオ入力パネルの上部のオーディオ波形は、ライブ配信の過去6秒間のオーディオ情報を表示します。波形は継続的に更新され、右から左にスクロールします。

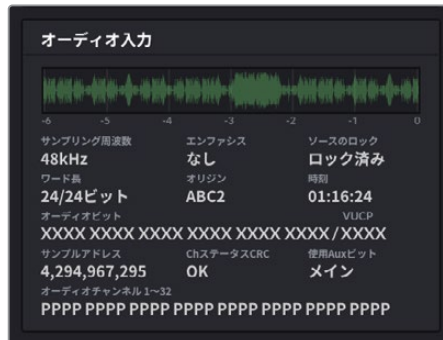

オーディオ波形表示の下では、オーディオ入力に関する技術情報の詳細を確認できます。

サンプリング周波数	SDI入力にエンベッドされているオーディオのサンプリング周波数レートを表示します。
エンファシス	オーディオソースのエンファシスオプションが有効になっているか表示します。
ソースのロック	オーディオソース周波数が外部リファレンスソースにロックされているか確認できます。
ワード長	SDI入力にエンベッドされているオーディオのビット深度を表示します。
オリジン	4文字でチャンネルの起点を表します。
時刻	フリーランタイムコード。
オーディオビット	SDI接続にエンベッドされたオーディオサンプルのビットアクティビティを表示します。オーディオチャンネルのステータスでオーディオが16、20、24ビットのいずれかで表示されていても、オーディオビットアクティビティで、実際のビット数を確認できます。
VUCP	VUCPビットは左から右に読みます。「V」は「Valid (有効性)」、「U」は「User (ユーザー)」、「C」は「Channel Status (チャンネルステータス)」、「P」は「Parity (パリティ)」を意味します。このフィールドはオーディオビットと同様に機能します。
サンプルアドレス	オーディオサンプルカウンター。
使用Auxビット	メインオーディオにAuxビットが使用されているかどうかを表示します。
オーディオチャンネル	1~32 各文字は、SDI入力にエンベッドされたオーディオチャンネルを意味します。「P」は、オーディオチャンネルが使用されていることを示し、「-」は該当のチャンネルにオーディオがないことを意味します。

データレート

過去60秒間のエンコーダーの現在のデータレートを表示します。データレートは、メガビット/秒 (Mb/s) で測定されます。このインジケータは、オフエアでも常に表示されます。これにより、オンエア前に帯域幅を正確に確認できます。

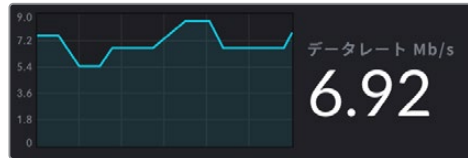

キャッシュ

Web Presenterに内蔵されたメモリーバッファの現在の使用率を表示します。グラフは過去60秒間の使用量を示します。キャッシュは、小容量の内蔵メモリーで、プログラム出力を継続的に保存および再生します。これは、配信データレートがビデオを持続できるレベルを下回った場合に、安全対策として機能します。

インターネットの不安定さは、多くの場合、ネットワークの使用状況やワイヤレス信号の弱さが原因です。そのため、データレートが下がった場合、それに応じてバッファデータが増加します。接続速度がビデオ配信をサポートできなくなるまで遅くなった場合、キャッシュがビデオフレームを埋め合わせます。しかし、キャッシュが100%フルに達すると、ビデオ配信に影響が出るため、キャッシュがフルになることは可能な限り回避する必要があります。ビデオフィードを接続し、配信を始めない状態で、モニター出力のキャッシュ表示を確認することでテストできます。キャッシュが頻繁に100%に近づくようであれば、ライブ配信設定で低品質を選択します。

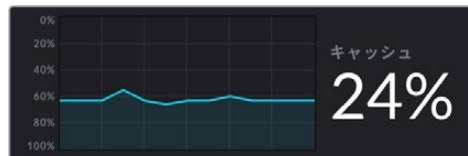

オーディオメーター

オーディオソースのレベルは、オーディオメーターでモニタリングできます。メーターは、Web Presenterのメニュー設定でPPMまたはVUレベルで表示するように設定できます。オーディオレベルが高過ぎる場合、メーターが赤くなります。これは、ライブ配信のオーディオが歪んだり、クリッピングが生じている可能性があることを意味します。オーディオが緑のセクションの上部付近に留まり、たまに黄色のセクションに達するように保つことが理想的です。

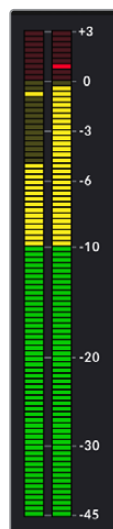

Web Presenter Setupの使用

Blackmagic Web Presenterがネットワークに接続されている場合、同じネットワーク上のあらゆるコンピュータを使用して、リモートでWeb Presenterを操作できます。Blackmagic Web Presenter Setupでは、ユニットのフロントパネルに搭載されているのと同じコントロールと設定にアクセスできます。

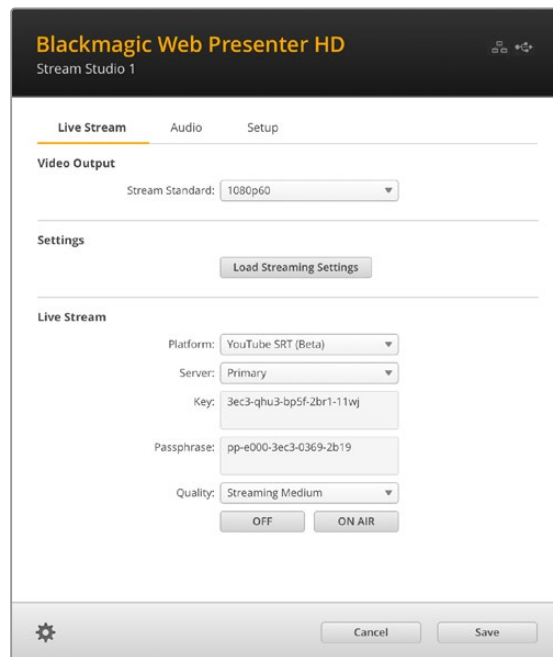
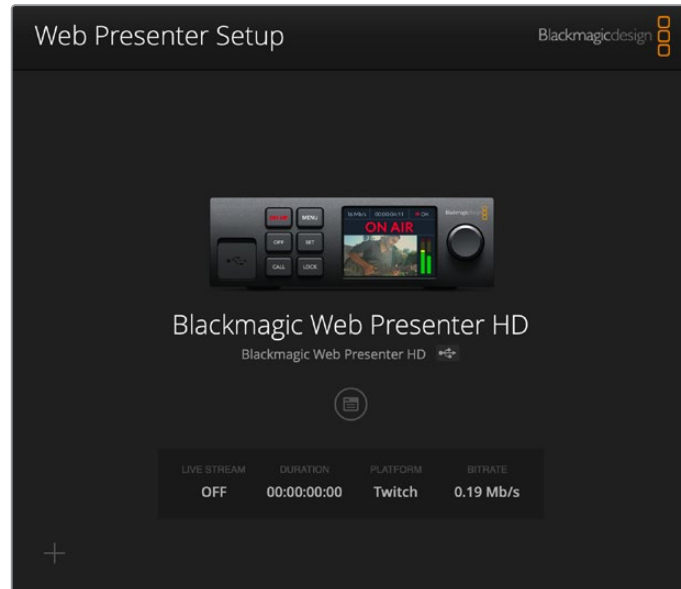

Live Stream (ライブ配信) タブ

Video Output (ビデオ出力)

Stream Standard (配信フォーマット)

「Stream Standard」メニューをクリックして、配信に使用するビデオ解像度を選択します。Web Presenterの機種によって、720p25から1080p60まで、または2160p60までを選択できます。

Settings (設定)

カスタム配信設定 (Blackmagic ATEM Streaming BridgeからのXMLファイルなど) がある場合、「Load Streaming Settings (配信設定をロード)」ボタンをクリックすると読み込みを実行できます。

カスタム設定の作成方法およびATEM Streaming Bridgeへの接続方法は、後述の「ATEM Streaming Bridgeでビデオリンクを構築」セクションを参照してください。

Live Stream (ライブ配信)

Platform (プラットフォーム)

「Platform」メニューをクリックして、放送に使用する配信プラットフォームを選択します。YouTube、Facebook、Twitchなどのオプションがあります。カスタム配信設定を読み込んでいる場合、ここにリストアップされます。

カスタムURLに配信するには、「プラットフォーム (Platform)」メニューからカスタムURLのオプションを選択します。Web Presenter 4KではカスタムURLにH.264またはH.265、Web Presenter HDではカスタムURLにH.264で配信できます。

Server (サーバー)

最寄りのサーバーをリストから選択します。サーバーのリストは、選択した配信プラットフォームにより異なります。

Instagram、Microsoft Teams、カスタムURLに配信している場合、サーバーのリストは編集可能なフィールドになります。配信プラットフォームのアカウントから割り当てられたURL、またはカスタムURLの詳細を入力します。

Key (キー)

配信プラットフォームから配信用に割り当てられたストリームキーを入力します。

Passphrase (パスフレーズ)

SRT配信プロトコルに対応した配信サービスを使用している場合、配信プラットフォームから割り当てられたパスフレーズを入力します。

Quality (品質)

Web Presenterの機種によって、HDまたは4Kから配信品質を選択します。

H.264	
HD	4K
HyperDeck High 45 to 70 Mb/s	HyperDeck High 95 to 220 Mb/s
HyperDeck Medium 25 to 45 Mb/s	HyperDeck Medium 66 to 150 Mb/s
HyperDeck Low 12 to 20 Mb/s	HyperDeck Low 38 to 80 Mb/s
Streaming High 6 to 9 Mb/s	Streaming High 34 to 51 Mb/s
Streaming Medium 4.5 to 7 Mb/s	Streaming Medium 23 to 35 Mb/s
Streaming Low 3 to 4.5 Mb/s	Streaming Low 13 to 20 Mb/s

H.265	
HD	4K
Streaming High 2.3 to 4.5 Mb/s	Streaming High 22.5 to 30 Mb/s
Streaming Medium 1.5 to 3 Mb/s	Streaming Medium 14 to 20 Mb/s
Streaming Low 0.8 to 2 Mb/s	Streaming Low 8 to 10 Mb/s

品質設定に使用されるデータレートは、Web Presenterが使用しているビデオフォーマットによって変わります。例えば「Streaming High」の品質を選択し、1080p24を使用している場合は、6 Mb/sのデータレートが使用されます。

表を見て分かる通り、配信データレートはHyperDeckレートより低くなっています。これにより、ディスクにデータを記録するのと比較して、概して低い帯域幅を使用するインターネットを介してデータを送信できます。

各設定で、2つの数値がデータレートとして記載されていますが、低い方の数値は低いフレームレート（24p、25p、30p）に使用され、高い方の数値は高いフレームレート（50p、60p）に使用されます。配信品質のデフォルト設定は、「Streaming High」です。この設定は、非常に高品質のチャンネル配信が可能です。

OFFおよびON AIRボタン

ライブ配信の開始と停止は「OFF」および「ON AIR」ボタンで操作できます。ライブ配信中、「ON AIR」ボタンは赤く点灯します。

読み込んだ設定の削除

読み込んだすべての設定をWeb Presenterから削除するには、「Live Stream (ライブ配信)」タブの左下にあるギアのアイコンをクリックします。削除を確定するには「Remove (削除)」をクリックします。

Audio (オーディオ) タブ

このタブには、Web Presenterのオーディオモニタリング出力やオーディオメーターに関する設定が含まれています。

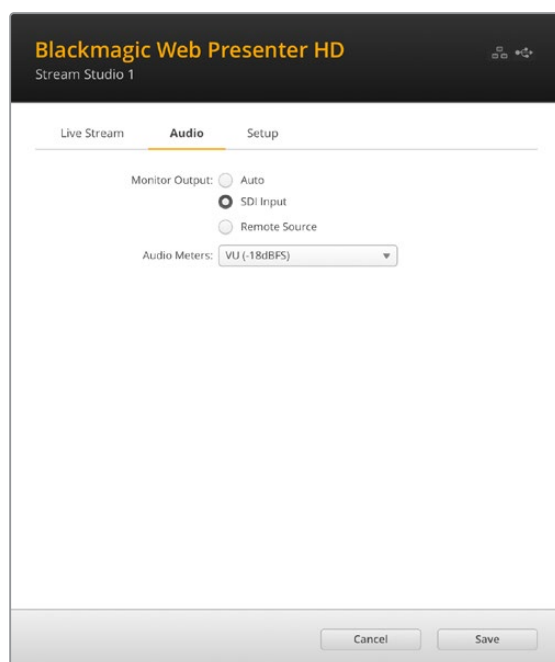

Monitor Output (モニター出力)

Web PresenterのSDIおよびHDMIモニター出力に使用するオーディオソースを選択します。

Auto (オート)

モニター出力が「Auto」に設定されていると、Web PresenterはATEMスイッチャーからATEM Streaming Bridgeを介して送信されているトークバックオーディオを自動的に検出してモニタリングします。トークバックが検出されない場合、SDI入力からのオーディオが使用されます。

SDI Input (SDI入力)

「SDI Input」を選択すると、Web PresenterのSDI入力ソース（例えば、接続されているBlackmagic Studio Cameraなど）からのオーディオをモニタリングできます。

Remote Source (リモートソース)

遠隔のATEMスイッチャーまたはATEM Streaming Bridgeからのトークバックオーディオをモニタリングする際に選択します。

Audio Meters (オーディオメーター)

オーディオメーターのメニューを使用して、表示するオーディオメーターのタイプを選択します。リファレンスレベルとして選択できるオプションは、VU -18dBFS、VU -20dBFS、PPM -18dBFS、PPM -20dBFSです。

Setup (セットアップ) タブ

Blackmagic Web Presenter HD
Stream Studio 1

Live Stream Audio **Setup**

Name: Stream Studio 1
Language: English
Software: Version 3.3

Network

Protocol: DHCP Static IP
IP Address: 192.168.24.100
Subnet Mask: 255.255.255.0
Gateway: 192.168.24.1
Primary DNS: 8.8.8.8
Secondary DNS: 8.8.4.4
Connection Priority: Ethernet Mobile

Reset

Factory Reset

Cancel Save

Name (名前)

Web Presenterに名前を付けたい場合は、ボックスに新しい名前を入力し、「Save」をクリックします。

Language (言語)

Web Presenter HDの言語設定を変更できます。

Software (ソフトウェア)

Web Presenterの現在のソフトウェアのバージョンを表示します。

Network (ネットワーク)

ネットワークのコンフィギュレーションに関するオプション（DHCPを介したネットワークへの接続、または静的IPアドレスの使用など）を選択できます。Web Presenterをネットワークに接続する方法に関しては「ネットワーク設定」セクションを参照してください。

Connection Priority (優先接続)

Web Presenterにイーサネットと携帯電話の両方が接続されている場合、配信に使用する接続をこの設定で選択できます。携帯電話でのテザリングに関しては「スマートフォンを使用した配信」セクションを参照してください。

Reset (リセット)

「Factory Reset (出荷時設定にリセット)」ボタンをクリックすると、Web Presenterをリセットできます。

ネットワーク設定

Web Presenterは、静的IPアドレスまたはDHCPでネットワークに接続できます。

DHCP – 使用しているユニットに自動的にIPアドレスを設定し、その他の設定を変更することなくネットワークに接続します。

DHCP (ダイナミック・ホスト・コンフィギュレーション・プロトコル) は、ネットワークサーバー上のサービスで、Web Presenterを自動的に検出してIPアドレスを割り当てます。DHCPは、イーサネット経由で機材を簡単に接続し、IPアドレスの競合が生じません。コンピューターやネットワークスイッチの多くは、DHCPをサポートしています。

Static IP Address (静的IPアドレス) – IPアドレスを自分で設定したい場合は、「Protocol (プロトコル)」設定を「Static IP Address」に設定し、マニュアルでIP設定を変更します。

静的IPアドレスは、Web Presenterを再起動しても変わりません。

Web Presenterを企業のネットワークに接続する際は、静的IPアドレスを使用する必要がある場合があります。ネットワーク管理者がいる場合、ネットワークに接続されたすべての機器にカスタムIPアドレスが割り当てられている可能性があります。ネットワーク管理者が会社のコンピューターおよびネットワークを管理している場合は、ネットワーク管理者に確認するのが一番です。

直接配信のためにインターネットの共有を設定する

Web Presenterをネットワークスイッチやインターネットルーターに直接接続できない場合は、コンピューターのインターネット接続をイーサネットを介してWeb Presenterと共有することが可能です。

Blackmagic Web Presenterで直接配信を実行できるように設定する：

- 1 Web PresenterがDHCPを使用するように設定します。
- 2 イーサネットポートを通じてインターネット接続を共有できるようにコンピューターを設定します。
Mac: システム環境設定で「Sharing」をクリックし、「Service」リストから「Internet Sharing」を選択します。使用しているMacがWifiでインターネットに接続されている場合、「Share your connection from」メニューで「Wifi」を選択します。「To computers using」リストで「Ethernet」を選択します。「Service」リストで「Internet Sharing」のチェックボックスをチェックします。インターネットの共有をオンにしたいか確認されるので、「Start」をクリックします。
Windows: スタートボタンを右クリックし、「ネットワーク接続」を選択します。「ネットワークの接続」スクリーンが表示されます。「アダプターのオプションを変更する」をクリックします。コンピューターのネットワーク接続がリストアップされます。インターネット接続を右クリックし、「プロパティ」を選択します。「共有」タブで「ネットワークのほかのユーザーに、このコンピューターのインターネット接続をとおしての接続を許可する」をクリックします。メニューでネットワーク接続を選択して「OK」をクリックします。
- 3 Web Presenterをコンピューターのイーサネットポートに接続します。数秒後、DHCPがWeb PresenterにIPアドレスを割り当てます。
- 4 ユニットのLCDスクリーンの右上にイーサネットアイコンが表示されるか確認して、Web Presenterがイーサネット経由でインターネットに接続しているかチェックします。

スマートフォンを使用した配信

Blackmagic Web Presenterは、スマートフォンでテザリングして配信を実行できます。つまり、スマートフォンのサービスエリア内であれば、あらゆる場所から世界に向けて配信が行えます。

携帯電話のテザリングをセットアップする:

- 1 スマートフォンをUSB-CケーブルでBlackmagic Web Presenterに接続します。USB-Cコネクタは、フロントまたはバックパネルのどちらでも使用できます。
- 2 スマートフォンのインターネットホットスポットを有効にします。

iOSデバイスでは「Settings」に進み、「Personal Hotspot」を開きます。「Allow Others to Join」を有効にします。Androidデバイスでは、スクリーンをスワイプして、クイック設定パネルを表示します。ホットスポットアイコンを長押しして、USBテザリングを有効にします。

Web Presenterの「ON AIR」ボタンを押すと、ライブ配信を行う準備が整います。

作業のこつ 配信が終了したら、スマートフォンのバッテリーを節約するためにテザリング接続をオフにすることをお勧めします。

Web Presenterにイーサネットケーブルが接続されている場合、携帯電話のインターネットテザリングを使用するように設定されていることを確認するメッセージが表示されます。Web Presenter Setup Utilityを開き、「Setup」タブに進みます。「Network」セクションで「Connection Priority (優先接続)」で「Mobile (携帯)」を選択します。

Blackmagic Web Presenter HDをウェブカメラとして使用する

SkypeやZoomなどのソフトウェアは、Web Presenterをウェブカメラとして自動的に設定するので、アプリケーションを立ち上げると、Web Presenterからのビデオが即座に表示されます。アプリケーションがWeb Presenterを自動的に選択しない場合、アプリケーションがWeb Presenterをウェブカメラとマイクとして使用するようマニュアルで設定します。

以下は、Skypeでウェブカメラを設定する方法です。

- 1 Skypeのメニューバーで、「Audio & Video Settings」を開きます。
- 2 「Camera」メニューをクリックし、リストからWeb Presenterを選択します。プレビューウィンドウにWeb Presenterの映像が表示されます。
- 3 「Microphone」メニューでWeb Presenterをオーディオソースとして選択します。

Open Broadcasterのセットアップ

Open Broadcasterは、オープンソースのアプリケーションです。YouTube、Twitch、Facebook Liveなどのお気に入りの配信ソフトウェアとWeb Presenterの間に配信プラットフォームとして機能します。Open Broadcasterは、配信アプリが管理しやすいビットレートにビデオを圧縮します。

ここでは、配信サービスとしてYouTube Liveを使用して、Web Presenterのウェブカム出力を配信するように、Open Broadcasterをセットアップする方法を説明します。

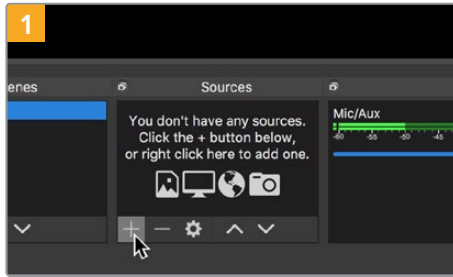

1 Open Broadcasterを起動し、「Sources」ボックスのプラスボタンを押します。

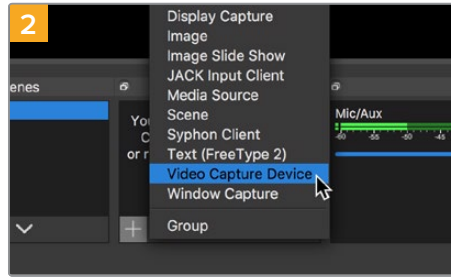

2 「Video Capture Device」を選択します。

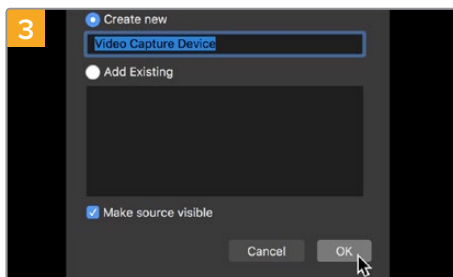

3 新しいソースに名前を付けて「OK」をクリックします。

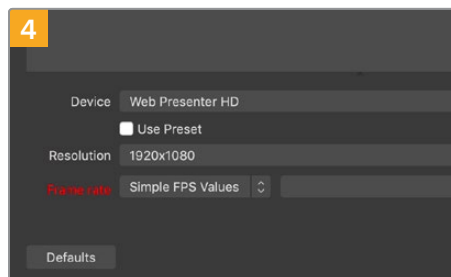

4 「Device」メニューで使用しているWeb Presenterの機種を選択して「OK」をクリックします。

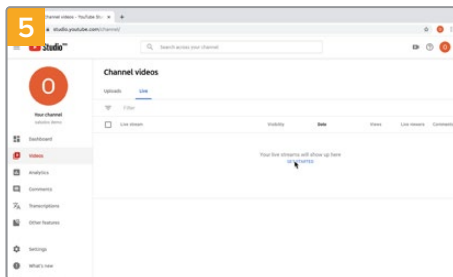

5 YouTubeのアカウントへ行きます。「Go live」ボタンを押して、「Stream」をクリックします。

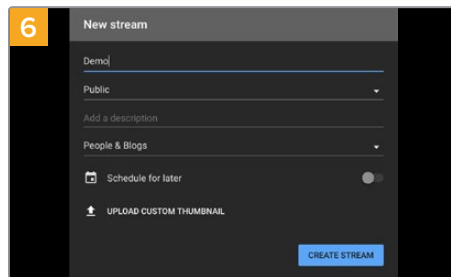

6 YouTubeの「Stream」オプションで、配信の詳細を入力し、「Create Stream」をクリックします。

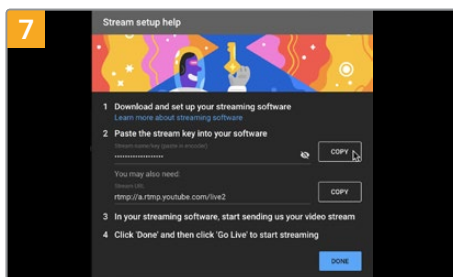

7 YouTubeは、使用するYouTubeアカウントにOpen Broadcasterがアクセスできるようにするためのストリームキーを生成します。

ストリームキーの横にある「COPY」ボタンをクリックします。コピーしたストリームキーは、次のステップでOpen Broadcasterにペーストします。

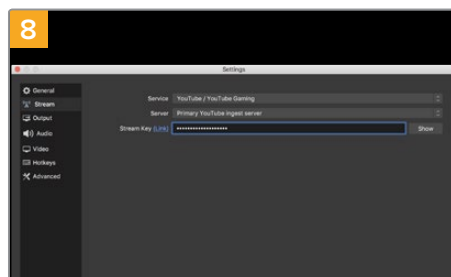

8 Open Broadcasterに戻り、メニューバーの「OBS/Preferences」をクリックして環境設定を開きます。「Stream」を選択します。YouTubeでコピーしたストリームキーを「Stream Key」にペーストして「OK」をクリックします。

Open Broadcasterの配信プレビューウィンドウにWeb Presenterの映像が表示されます。

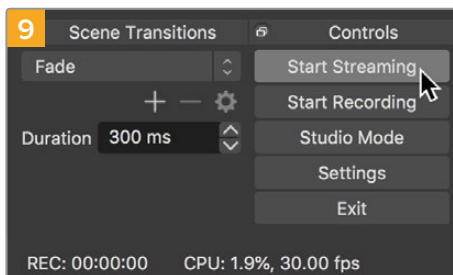

Open Broadcasterの放送リンクをYouTubeに接続するには、スクリーン右下で「Start Streaming」をクリックします。これで、Open BroadcasterからYouTubeへのリンクが構築されました。ここからは、すべてがYouTube Liveを使って設定されます。

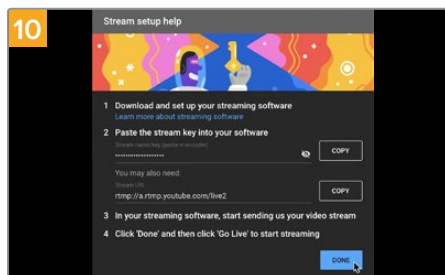

YouTube Liveに戻ると、Web Presenterのウェブカメラプログラム出力がバックグラウンドに表示されます。「DONE」をクリックします。

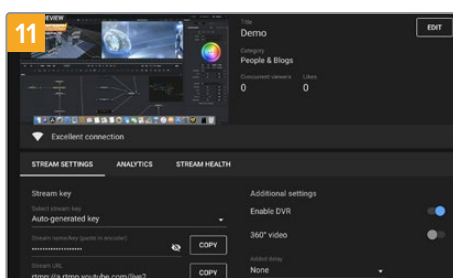

Open BroadcasterがYouTube Liveと通信している状態になったので、放送を開始できます。すべてが適切に設定されているか、最終チェックを行ってください。

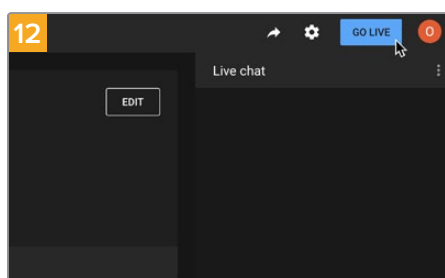

準備が整ったら、「GO LIVE」をクリックして放送を開始します。

Open Broadcasterを使ったYouTubeでのライブ配信が始まりました。

メモ インターネットの性質上、配信に遅延が生じることが多々あります。放送の最後の部分をカットしてしまわないよう、「End Stream」をクリックする前に、実際のYouTubeの配信を見て、プログラムが終了したことを確認することが重要です。

ATEM Streaming Bridgeでビデオリンクを構築

ATEM Streaming Bridgeは、Web Presenterからの配信ビデオをデコードし、SDIまたはHDMIビデオに変換します。これにより、ローカルネットワークを介して、または世界中にインターネットを介して、ビデオを送信できます。

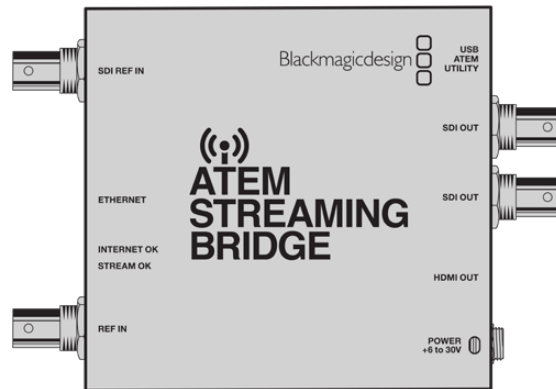

ATEM Streaming BridgeがWeb Presenterと同じローカルネットワークに接続されている場合、Web Presenter Setupの「Live Stream (ライブ配信)」タブの「Platform (プラットフォーム)」メニューに表示されます。

別の方法として、配信設定のXMLファイルが保存されたUSBドライブをWeb Presenterに接続するか、Web Presenter Setupを使用してコンピューターを介して、ファイルの設定をロードすることも可能です。

例えば、Blackmagic Web PresenterをATEM Streaming Bridgeと使用すると、天気予報を遠隔地からスタジオに送信できます。ロケ先から送信するために必要なものは、Web Presenterとインターネット接続だけです。スマートフォンでのテザリング、またはネットワークへの接続のいずれかでインターネットに接続します。

スタジオでは、ATEM Streaming Bridgeがインターネットフィードを受信し、SDIに変換するので、スタジオにあるメインのスイッチャーに接続できます。

この例のワークフローをセットアップする：

- 1 ロケ地で、Blackmagic Web PresenterをスイッチャーのSDIプログラム出力に接続します。例えば、ATEM Constellation 8Kです。
- 2 Blackmagic Web Presenterをスマートフォンに接続します。
- 3 スタジオで、ATEM Streaming Bridgeをイーサネットインターネットに接続します。
- 4 ATEM Streaming BridgeはインターネットからのSDIビデオフィード変換し、ニュース放送用にスタジオのスイッチャーのSDI入力に送信します。

スタジオでATEM Streaming BridgeをWeb Presenterのインターネットフィードに接続するには、ATEM Setup Utilityを起動し、インターネット設定をコンフィギュレーションする必要があります。これには、配信の全設定を含むXMLファイルの生成も含まれます。このXMLファイルは、ロケ地にあるWeb Presenterでロードできます。

XMLファイルの作成

XML設定ファイルを作成するには、ATEM Streaming Bridgeの「ETHERNET」ポートからネットワークケーブルをインターネットルーターまたはネットワークスイッチにつなげて、インターネットに接続します。

ATEM Streaming BridgeをUSB-Cケーブルでコンピューターに接続し、ATEM Setupを立ち上げます。

「Setup (セットアップ)」タブで、ネットワーク設定が正しいか確認し、「Stream Service (配信サービス)」で「Internet (インターネット)」を選択します。インターネットステータスに「Visible Worldwide」と表示されます。これは、すべてが正常に機能していることを意味します。

ポート転送に関して

「Internet Status (インターネットステータス)」に、ポート転送やUPnPにおけるエラーが表示されている場合、インターネットプロバイダーまたはネットワーク管理者に、使用しているインターネット接続でポート転送を「TCP port 1935」に設定するように依頼する必要があります。

XMLファイルの書き出し

ATEM Setupのタブで設定を確認し、ATEM Streaming Bridgeをネットワークまたはインターネットに接続したら、XML設定ファイルを書き出せます。

- 1 ウィンドウの右上にある「External ATEM Mini Pro (外部ATEM Mini Pro)」タブをクリックします。

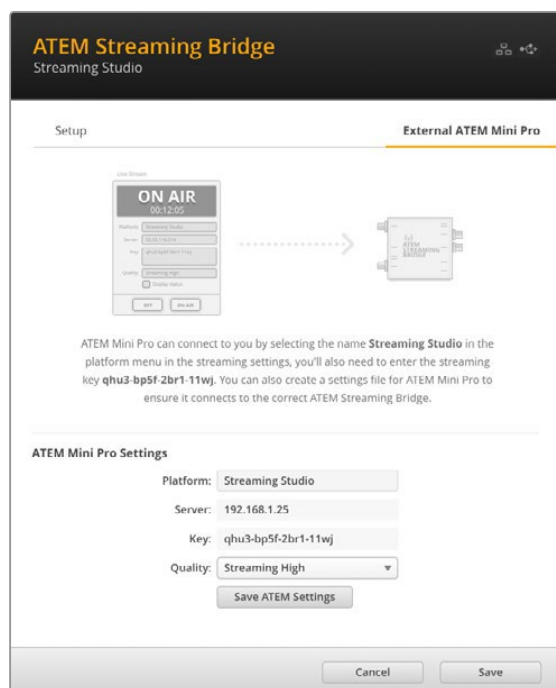

- 2 プラットフォームの名前をカスタマイズするには、「Platform (プラットフォーム)」をクリックし、新しい名前を入力します。この名前は、リモートのBlackmagicユニットのプラットフォームメニューのリストに表示されます。
- 3 配信の品質を選択します。これにより、リモートのWeb Presenterの品質が設定されます。
- 4 「Save ATEM Settings (ATEMの設定を保存)」ボタンをクリックし、XMLファイルの保存先を選択したら、「Save」をクリックします。
- 5 保存したXMLファイルは、遠隔で作業する担当者にメールで送信できます。

作業のこつ ATEM Setupのトークバック設定を使用すると、リモートのWeb Presenterに返送するオーディオチャンネルを選択できます。

XMLファイルのローディング

ロケ先に設定ファイルを電子メールで送信すると、ロケ地のスタッフはBlackmagic Web Presenter Setupを使用して、XMLをWeb Presenterにロードできます。その後は、ON AIRを押すだけで、スタジオへの天気予報の配信を開始できます！

配信用のXMLファイルを一度ロードしたら、その後ロードを繰り返すことなく配信を開始・停止できます。これにより、Web PresenterおよびATEM Streaming Bridgeを繋ぐ、継続的なビデオリンクを簡単にセットアップできます。

スタジオにあるATEM Streaming Bridgeの配信およびネットワーク設定が変更されず、またATEM Streaming BridgeがWeb Presenterを探し続ける限り、インターネット上の場所に関わらず、必ずWeb Presenterを見つけることができます。ロケ先など、場所を問わず、Web Presenterをインターネットに接続し、「ON AIR」を押すと、スタジオのATEM Streaming Bridgeに即座に配信を開始します。

ATEM Streaming Bridgeの使用の詳細は、ATEM Miniマニュアルを参照してください。同マニュアルは、www.blackmagicdesign.com/jp/supportからダウンロードできます。

タリー、トークバック、カメラコントロール

ATEM Streaming BridgeおよびBlackmagic Web Presenterは、ATEMスイッチャーからのタリー、トークバック、カメラコントロールの情報を送信できます。つまり、SDIベースのBlackmagic Designカメラをローカルネットワーク内や、インターネットを介して世界各地のあらゆる場所にセットアップして、タリー、トークバック、カメラコントロール機能を使用できます。

設定は極めてシンプルです。以下の図は、URSA Mini Pro 4.6Kをローカルネットワークを介して、ATEM Constellation 8Kに接続し、タリー、トークバック、カメラコントロールを使用する方法です。

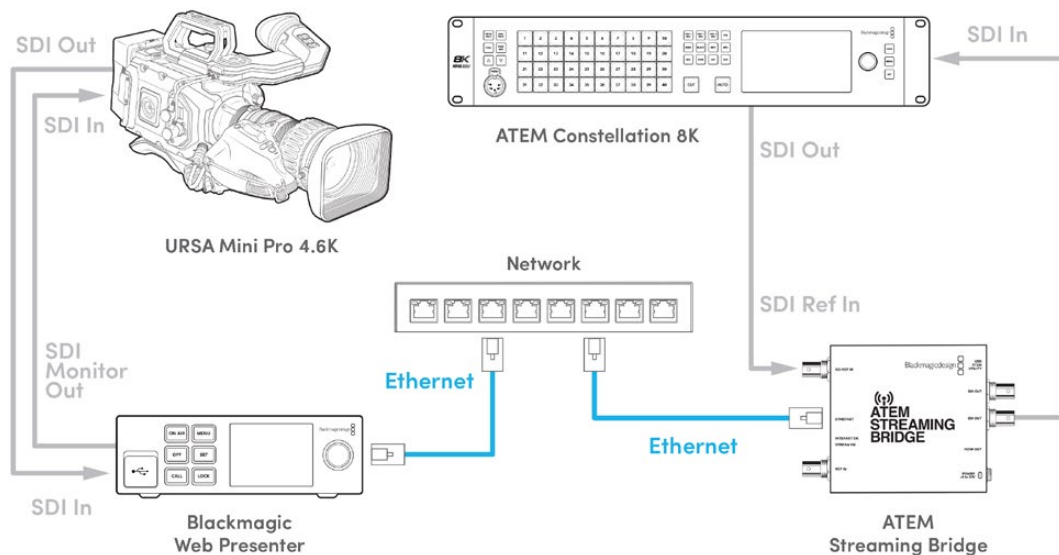

すべての機器が接続されたら以下を実行します：

- 1 Blackmagic Web Presenterの「MENU」ボタンを押してLCDメニューを開き、「ライブ配信」メニューに進みます。
- 2 「プラットフォーム」でATEM Streaming Bridgeを選択します。
- 3 「SET」を押して確定します。

タリーを機能させるためには、カメラのATEMカメラIDをスイッチャーの入力にマッチさせる必要があります。ATEMカメラIDの設定方法に関しては、URSA Miniマニュアルを参照してください。

カメラをATEMスイッチャーのプログラム出力に切り替えることで、タリーが機能しているかテストできます。カメラでATEMカメラIDが適切に設定されている場合、タリーライトが点灯し、カメラのLCDの周囲にタリーの赤い枠が表示されます。カメラをプレビュー出力に切り替えると、タリーが緑に点灯します。

ATEM Software Controlのカメラページで、アイリスとペDESTALを調整し、カメラコントロールが機能しているかテストします。

エンベッドされたSDIオーディオチャンネルの15と16が、デフォルトのトークバックチャンネルとして設定されていますが、エンジニアチャンネルの13と14、またはATEM Setupユーティリティでプログラム出力に変更することが可能です。

インターネット経由で送信している場合、ATEM SetupユーティリティでXML設定ファイルが作成されます。このXMLファイルは、Blackmagic Web Presenterにロードされるので、インターネット上でATEM Streaming Bridgeを検出することが可能です。XML設定ファイルの作成およびローディング方法に関しては、前のセクションを参照してください。

URSA Broadcast G2の接続

URSA Broadcast G2には配信エンジンが内蔵されており、カメラのUSB-C拡張ポートから直接配信できるため、Blackmagic Web Presenterを使用する必要はありません。タリーを適切に機能させるためにATEMカメラIDを設定する方法などは、URSA Broadcast G2マニュアルを参照してください。

Blackmagic Universal Rack Shelf

Blackmagic Universal Rack Shelfは1Uラックの棚で、様々なBlackmagic Design機器を放送用ラックやロードケースに設置できます。モジュラー方式なので、同じ1Uラックの形状の製品を設置して、ポータブルで、実用的な機材のセットアップを構築できます。

以下の図は、3つのUniversal Rack Shelfを小さなラックに設置し、互換性のある様々なユニットをマウントした例です。一番下の棚には1/3ラック幅のブランクパネルが取り付けられており、ユニット間の使用されていないスペースをカバーしています。

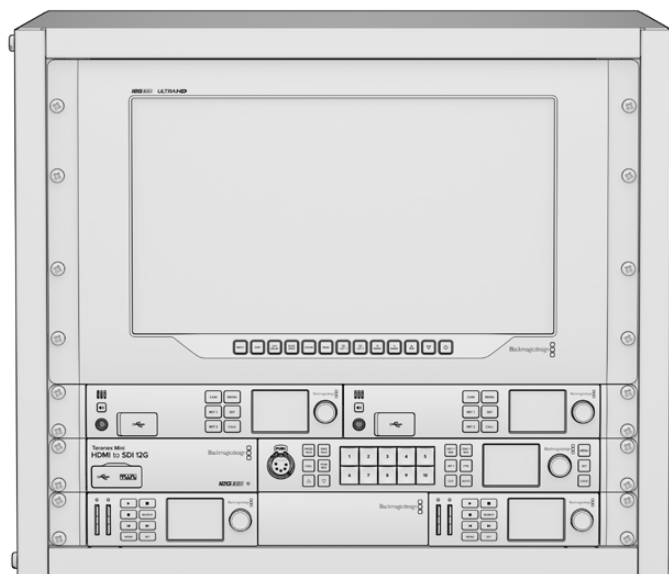

同梱物

Universal Rack Shelf Kitには、以下が含まれています。



Blackmagic Universal Rack Shelf x1

Blackmagic Designの製品を設置するための1Uラックの棚。

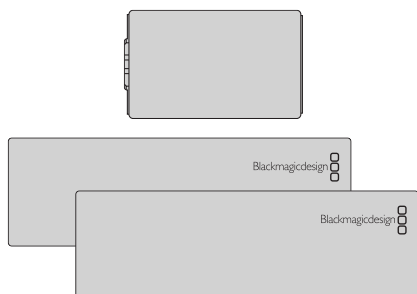

ブランクパネル

1/6ラック幅 x1、1/3ラック幅 x2。空いているスペースをカバーするブランクパネル。

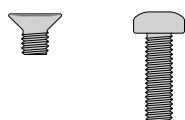

ネジ

M3 (5mm) 皿頭マウント用ネジ x12 M3 (9mm) ネジ (1/6ラック幅ブランクパネル用) x2

Universal Rack Shelfにユニットをマウントする

- 1 ゴム製の脚が付いている場合は、先端がプラスチックのスクレーパーでユニットから脚を取り外します。
- 2 棚とユニットの両方を上下逆さまにして置き、棚のプレートの穴とBlackmagic Design製品のマウント用のネジ穴が揃うように配置します。1/3ラック幅の製品には中央に2つのマウントポイント、1/2ラック幅の製品には最大3つのマウントポイントがあります。

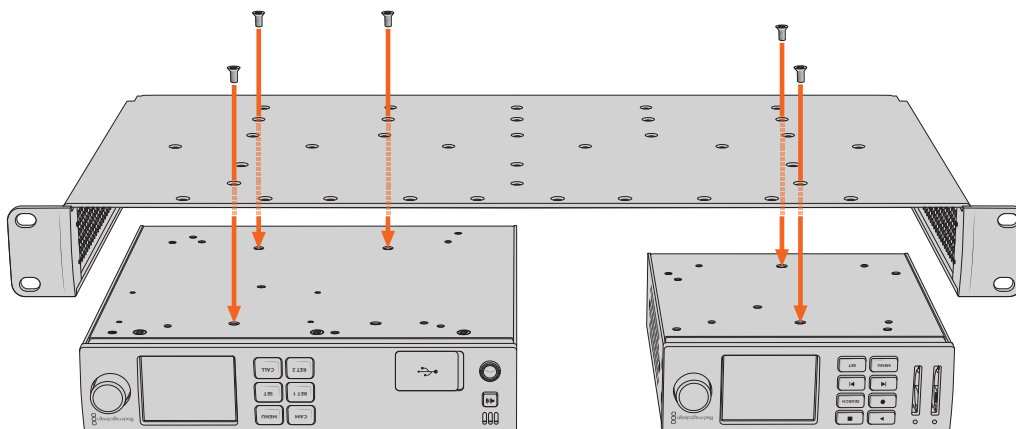

- 3 同梱のM3 (5mm) 皿頭ネジで、ユニットを棚にネジ留めします。
- 4 固定されたら、棚の向きを元に戻して、両側の取り付け金具でラックに取り付けます。

同梱のブラックパネルは、空いているラックスペースをカバーできます。

1/6ラック幅ブラックパネルの取り付け

1/6ラック幅ブラックパネルは、1/2ラック幅と1/3ラック幅のユニットを共にマウントする際に、空いているスペースをカバーするために使用できます。このパネルは、ユニットの側面に取り付けられます。空気の循環を考慮して、ユニットとユニットの間にパネルを設置することをお勧めします。

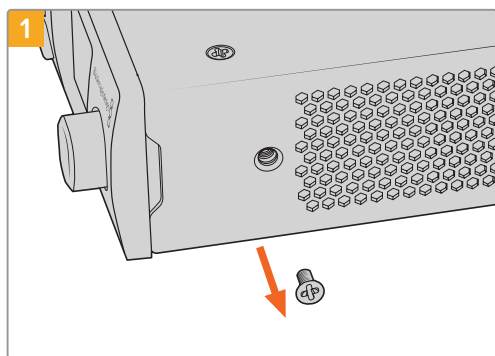

1 フロントの前面近くにあるM3 (5mm) 皿頭ネジを取り除きます。

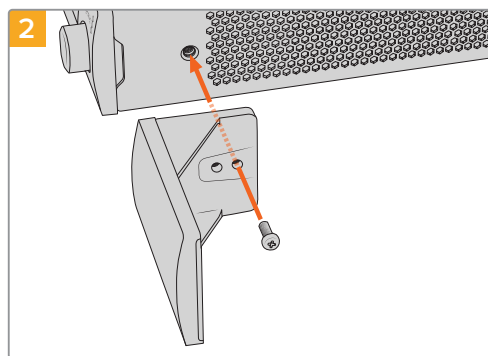

2 ブラックパネルをネジ穴に揃え、同梱のM3 (9mm) ネジで固定します。

1/3ラック幅ブラックパネルの取り付け

1/3ラック幅ブラックパネルは、1台のユニットをマウントする場合に、棚の両側に取り付けられます。ブラックパネルを取り付けるには、パネル底部のネジ穴と固定ポイントを棚と揃え、同梱のM3 (5mm) 皿頭ネジを2本使ってパネルを固定します。

内部ソフトウェアのアップデート

Setup Utilityでは、Web Presenterの内部ソフトウェアをアップデートでき、配信、ネットワーク、配信品質の設定も行えます。

内部ソフトウェアのアップデート：

- 1 最新のBlackmagic Web Presenterインストーラーをwww.blackmagicdesign.com/jp/supportからダウンロードします。
- 2 Blackmagic Web Presenterインストーラーを起動し、画面に表示される指示に従います。
- 3 インストールが完了したら、Web Presenterをリアパネルまたはフロントパネル（プラスチックのカバー付き）のUSBコネクタ経由でコンピューターに接続します。
- 4 Blackmagic Web Presenter Setupを起動し、画面に表示される指示に従って内部ソフトウェアをアップデートします。内部ソフトウェアが最新で何もする必要がない場合、指示は表示されません。

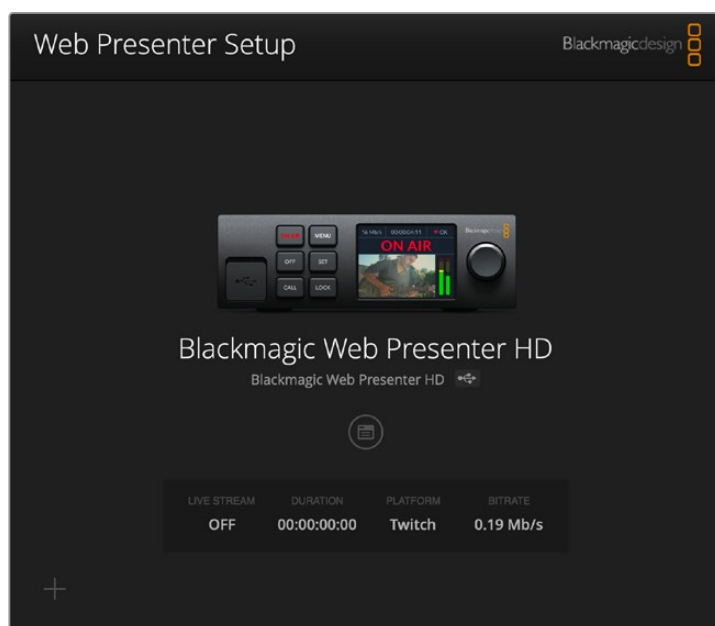

Blackmagic Web Presenter用の最新のSetup Utilityは、Blackmagic Designサポートセンター (www.blackmagicdesign.com/jp/support) でダウンロード可能。

Developer Information

Blackmagic Web Presenter Ethernet Protocol

v1.2

Protocol Details

Overview

The Blackmagic Web Presenter Ethernet Protocol is a line-oriented, text-based protocol to control a Web Presenter.

Lines from the Web Presenter server will be separated by an ASCII LF sequence.

Messages from the user may be separated by LF or CR LF.

Connection

The Web Presenter server is accessed by connecting to TCP port 9977 on a Web Presenter.

Connection Response

Upon connection, the Web Presenter server sends a dump of the device's state.

The Web Presenter server sends information in blocks, with each having an identifying header followed by a colon. A block spans multiple lines and is terminated by a blank line. Each line in the protocol is terminated by a newline character.

Following the header, a block contains either a single multi-line string or a sequence of key/value pairs arranged one per line. The first full-colon on a line is used to delimit the key and the value. A value may be a comma separated list. In this case, values in the list must have the “,” and “\” characters escaped with a “\” character.

To be resilient to future protocol changes, clients should ignore blocks they do not recognize, up to the trailing blank line. Within recognized blocks, clients should ignore keys they do not recognize.

Legend	
↵	End of line
...	and so on
Orange Text	Client Generated
Grey Text	Server Generated

The protocol preamble block is always the first block sent by the Web Presenter server:

```
PROTOCOL PREAMBLE:↵
```

```
Version: 1.2↵
```

```
↵
```

The version field indicates the protocol version. When the protocol is changed in a compatible way, the minor version number will be updated. If incompatible changes are made, the major version number will be updated.

The initial status dump is concluded by the end prelude block:

```
END PRELUDE:↵
```

```
↵
```

Status Updates

When any device parameter is changed on the Web Presenter server by any client, such as the Blackmagic Web Presenter Setup utility, the Web Presenter server resends the applicable status block, containing only the items that have changed. Status updates can also occur due to external changes such as tethering to a smartphone or when a streaming service is disconnected.

For example, if the input video mode is set to Auto, the following block will be sent:

```
STREAM SETTINGS:↵  
Video Mode: Auto↵  
↵
```

Requesting Changes

To change one or more parameters in a block, the client should send the appropriate block header in the same form the Web Presenter server sends, followed by the key/value pairs to be changed. For example, to change the input video format to 1080p59.94, the user should send the following block:

```
STREAM SETTINGS:↵  
Video Mode: 1080p59.94↵  
↵
```

The block must be terminated by a blank line. On receipt of a blank line, the Web Presenter server will either acknowledge the request by responding:

```
ACK↵  
↵
```

or if unable to parse the block responding with:

```
NACK↵  
↵
```

After a positive response, the client should expect to see a status update from the Web Presenter server showing the status change. This is likely to be the same as the command that was sent, sometimes followed by other blocks providing data specific to the change.

```
STREAM SETTINGS:↵  
Video Mode: 1080p59.94↵  
↵
```

If the Web Presenter server does not understand a key in the requested block, the key will be ignored. If an invalid value is provided for a known key, then the request is ignored and the Web Presenter will respond with the existing value for the key. In both cases the Web Presenter server will still respond with an ACK.

```
STREAM SETTINGS:↵  
Video Mode: UnsupportedMode↵  
↵  
ACK↵  
↵  
STREAM SETTINGS:↵  
Video Mode: 1080p59.94↵  
↵
```

Requesting a Status Dump

The user may request that the Web Presenter server resend the complete state of any status block by sending the block header, followed by a blank line. In the following example, the user requests the Web Presenter server resend the stream settings:

```
STREAM SETTINGS:↵
↵
ACK↵
↵
STREAM SETTINGS:↵
Video Mode: 1080p59.94↵
...
↵
```

Protocol Blocks

Identity Block

The identity block contains information to identify the connected Web Presenter.

Block Syntax

The following example shows the Identity Block for a Blackmagic Web Presenter HD.

```
IDENTITY:↵
Model: Blackmagic Web Presenter HD↵
Label: Blackmagic Web Presenter HD↵
Unique ID: 00112233445566778899AABBCCDDEEFF↵
↵
```

Parameters

Key	Read/Write	Description	Valid Values
Model	Read only	The Web Presenter model name	String
Label	Read/Write	A display name for the Web Presenter	String
Unique ID	Read only	A device specific unique identifier	Hexadecimal ID

Changing Device Label

A device label to identify the Web Presenter can be changed by sending an identity block with label key.

```
IDENTITY:↵
Label: My Web Presenter↵
↵
ACK↵
↵
IDENTITY:↵
Label: My Web Presenter↵
↵
```

Version Block

The version block contains hardware and software version information for the connected Web Presenter.

Block Syntax

```
VERSION:↵  
Product ID: BE73↵  
Hardware Version: 0100↵  
Software Version: 0123ABCD↵  
Software Release: 3.3↵  
↵
```

Parameters

Key	Read/Write	Description	Valid Values
Product ID	Read only	The Web Presenter product ID	Hexadecimal ID
Hardware Version	Read only	The Web Presenter hardware version	Hexadecimal version
Software Version	Read only	The Web Presenter software version	Hexadecimal version
Software Release	Read only	The Web Presenter software release version	Version Number

Network Blocks

The network block contains the TCP/IP networking configuration for the connected Web Presenter.

Block Syntax

This example shows the output for a connected Web Presenter. It displays 2 networking interfaces - the Gigabit Ethernet interface and option for a tethered smartphone.

The network settings prefixed with Current show the active TCP/IP settings, and are read-only. The Current settings reflect either the DHCP or Static configuration, depending on the Dynamic IP flag.

```
NETWORK:↵  
Interface Count: 2↵  
Default Interface: 0↵  
↵  
NETWORK INTERFACE 0:↵  
Name: Ethernet↵  
Priority: 1↵  
MAC Address: 00:11:22:33:44:55↵  
Dynamic IP: true↵  
Current Addresses: 192.168.1.10/255.255.255.0↵  
Current Gateway: 192.168.1.1↵  
Current DNS Servers: 192.168.1.1, 8.8.8.8, 8.8.4.4↵  
Static Addresses: 10.0.0.2/255.255.255.0↵  
Static Gateway: 10.0.0.1↵  
Static DNS Servers: 8.8.8.8, 8.8.4.4↵  
↵
```

```

NETWORK INTERFACE 1:↵
Name: USBEthernet↵
Priority: 0↵
MAC Address: 00:00:00:00:00:00↵
Dynamic IP: true↵
Current Addresses: 0.0.0.0/255.255.0.0↵
Current Gateway: 0.0.0.0↵
Current DNS Servers: ↵
Static Addresses: 10.0.0.2/255.255.255.0↵
Static Gateway: 10.0.0.1↵
Static DNS Servers: 8.8.8.8, 8.8.4.4↵
↵

```

Parameters

Network Block

Key	Read/Write	Description	Valid Values
Interface Count	Read only	The number of networking interfaces supported by the Web Presenter	Integer
Default Interface	Read only	The default networking interface	Integer

Network Interface Block

Key	Read/Write	Description	Valid Values
Name	Read only	The name of the networking interface	String
Priority	Read/Write	The priority of the network interface. When multiple network interfaces are available, the high priority interface will become the default	Unsigned integer. The higher number is the higher priority
MAC Address	Read Only	MAC address of the networking interface	IEEE 802 MAC address
Dynamic IP	Read/Write	Selects DHCP or Static IP configuration	true - DHCP enabled false - Static IP
Current Addresses	Read Only	The current IP address and Subnet mask	{IPv4 address}/{Subnet Mask}
Current Gateway	Read Only	The current IP gateway address	IPv4 address
Current DNS Servers	Read only	The IP addresses of the current DNS servers	Comma separated list of IPv4 addresses
Static Addresses	Read/Write	Status IP address and subnet mask when DHCP disabled	{IPv4 address}/{Subnet Mask}
Static Gateway	Read/Write	Static gateway address when DHCP disabled	IPv4 address
Static DNS Servers	Read/Write	The IP addresses of the static DNS servers	Comma separated list of IPv4 addresses

Changing Networking Settings

The network can be configured to use either DHCP or a static configuration. To enable DHCP on Network Interface 0:

```
NETWORK INTERFACE 0:↵  
Dynamic IP: true↵  
↵  
ACK↵  
↵  
NETWORK INTERFACE 0:↵  
Dynamic IP: true↵  
↵
```

To set a fixed IP address, supply all static parameters:

```
NETWORK INTERFACE 0:↵  
Dynamic IP: false↵  
Static Addresses: 192.168.1.2/255.255.255.0↵  
Static Gateway: 192.168.1.1↵  
Static DNS Servers: 8.8.8.8, 8.8.4.4↵  
↵  
ACK↵  
↵  
NETWORK INTERFACE 0:↵  
Dynamic IP: false↵  
Static Addresses: 192.168.1.2/255.255.255.0↵  
Static Gateway: 192.168.1.1↵  
Static DNS Servers: 8.8.8.8, 8.8.4.4↵  
↵
```

Changing network settings may cause the IP connection to be dropped.

UI Settings Block

The UI settings block contains the front panel LCD and monitor output settings for the connected Web Presenter.

Block Syntax

```
UI SETTINGS:↵  
Available Locales: en_US.UTF-8, zh_CN.UTF-8, ja_JP.UTF-8, ko_KR.UTF-8, es_↵  
ES.UTF-8, de_DE.UTF-8, fr_FR.UTF-8, ru_RU.UTF-8, it_IT.UTF-8, pt_BR.UTF-8,↵  
tr_TR.UTF-8, pl_PL.UTF-8, uk_UA.UTF-8↵  
Current Locale: en_US.UTF-8↵  
Available Audio Meters: PPM -18dB, PPM -20dB, VU -18dB, VU -20dB↵  
Current Audio Meter: PPM -20dB↵  
↵
```

Parameters

Key	Read/Write	Description	Valid Values
Available Locales	Read only	The locales available in the Web Presenter	Comma separated list of locales
Current Locale	Read/Write	The current locale for Web Presenter	Refer to the locales from the Available Locales field
Available Audio Meters	Read only	The available audio meters supported by the Web Presenter	Comma separated list of audio meter types
Current Audio Meter	Read/Write	The current audio meter	Refer to the audio meters from the Available Audio Meters field

Stream Settings Block

The stream settings block contains the stream configuration for the connected Web Presenter.

Block syntax

This example shows the output for a connected Web Presenter. The stream settings prefixed with Current show the active stream settings and are writable. The stream settings prefixed by Available show the available stream settings for the device or platform and are read-only. To view the available servers or quality levels for a stream service, the Current Platform stream setting should be set first.

```
STREAM SETTINGS:↵
Available Video Modes: Auto, 1080p23.98, 1080p24, 1080p25, 1080p29.97,
1080p30, 1080p50, 1080p59.94, 1080p60, 720p25, 720p30, 720p50, 720p60↵
Video Mode: 1080p59.94↵
Current Platform: YouTube↵
Current Server: Primary↵
Current Quality Level: Streaming Medium↵
Stream Key: abc1-def2-ghi3-jkl4-mno5↵
Password: ↵
Current URL: srt://192.168.8.51
Customizable URL: true
Available Default Platforms: YouTube RTMP, YouTube SRT (Beta), Facebook,
Twitch, Twitter, Restream.IO, Vimeo, BoxCast, CastR, AfreecaTV, Bilibili,
DouYu, Weibo↵
Available Custom Platforms: My Platform↵
Available Servers: Primary, Secondary↵
Available Quality Levels: HyperDeck High, HyperDeck Medium, HyperDeck Low,
Streaming High, Streaming Medium, Streaming Low↵
↵
```

Parameters

Key	Read/Write	Description	Valid Values
Available Video Modes	Read only	The video modes available in the Web Presenter	Comma separated list of video modes
Video Mode	Read/Write	The current video mode	Refer to the video modes from the <i>Available Video Modes</i> field
Current Platform	Read/Write	The selected streaming platform	Refer to the platforms from the <i>Available Default Platforms</i> and <i>Available Custom Platforms</i> fields
Current Server	Read/Write	The current server for the streaming platform	Server is dependent on selected Current Platform
Current Quality Level	Read/Write	The current streaming quality level	Quality level is dependent on selected Current Platform
Stream Key	Read/Write	The stream key for the streaming platform	String
Password	Read/Write	The passphrase for an encrypted SRT stream	String
Current URL	Read/Write	The current URL for the streaming platform. This field is writable if <i>Customizable URL</i> field is true.	String
Customizable URL	Read only	A boolean specifying whether custom URLs are supported by the streaming platform	true - Custom URLs are supported false - Custom URLs are not supported
Available Default Platforms	Read only	The available default streaming platforms	Comma separated list of default platforms
Available Custom Platforms	Read only	The custom streaming platforms loaded in the Web Presenter	Comma separated list of custom platforms
Available Servers	Read only	The available servers for the selected streaming platform	Comma separated list of servers
Available Quality Levels	Read only	The available quality levels for the selected streaming platform	Comma separated list of quality levels

Changing Stream Settings

The stream settings can be changed by providing a stream settings block. The following is an example of streaming a 1080p59.94 input on Twitch with a medium stream quality.

```

STREAM SETTINGS:↵
Video Mode: 1080p59.94↵
Current Platform: Twitch↵
Current Server: US West: Los Angeles, CA↵
Current Quality Level: Streaming Medium↵
Stream Key: live_123456789_1aB2cD3eF4gH5iJ6kL7mN8oP9qR0sT↵
↵
ACK↵
↵
STREAM SETTINGS:↵
Video Mode: 1080p59.94↵
Current Platform: Twitch↵
Current Server: US West: Los Angeles, CA↵
Current Quality Level: Streaming Medium↵
Stream Key: live_123456789_1aB2cD3eF4gH5iJ6kL7mN8oP9qR0sT↵
↵

```

Stream XML Block

The stream XML block allows users to configure the Web Presenter with a custom configuration file in XML format.

Block syntax

The following example shows an XML file - Custom.xml has been loaded to configure the stream settings in the Web Presenter.

```
STREAM XML:↵  
Files: Custom.xml↵  
↵
```

Parameters

Key	Read/Write	Description	Valid Values
Files	Read/Write	The XML files loaded in Web Presenter	Comma separated list of filenames
Action	Write only	The stream XML action	Remove Remove All"

Adding a Stream XML file

An XML file can be loaded onto a Web Presenter by sending the stream xml command with a filename, then provide the contents of the XML file. After adding the XML file, the Available Custom Platforms field in the STREAM SETTINGS block will be updated with the new platforms, however the Current items will remain unchanged.

For the Stream XML block to be parsed correctly, any blank lines should be removed from the XML files.

Refer to the `Blackmagic Stream XML File Format` section in this manual for description of the Stream XML file format.

```
STREAM XML Custom.xml:↵  
<?xml version="1.0" encoding="UTF-8"?>↵  
<streaming>↵  
    <service>↵  
        <name>My Custom Platform</name>↵  
        ...  
    </service>↵  
</streaming>↵  
↵  
ACK↵  
↵  
STREAM XML Custom.xml:↵  
<?xml version="1.0" encoding="UTF-8"?>↵  
<streaming>↵  
    <service>↵  
        <name>My Custom Platform</name>↵  
        ...  
    </service>↵  
</streaming>↵  
↵
```

```
STREAM XML:↵
Files: Custom.xml↵
↵
STREAM SETTINGS:↵
Available Custom Platforms: My Custom Platform↵
↵
```

Removing a Stream XML file

An XML file can be removed from the Web Presenter by sending the stream xml command with the remove action.

```
STREAM XML:↵
Action: Remove↵
Files: Custom.xml↵
↵
ACK↵
↵
STREAM XML:↵
Files:↵
↵
STREAM SETTINGS:↵
Available Custom Platforms:↵
↵
```

Removing all Stream XML files

All XML files can be removed from the Web Presenter by sending the stream xml command with the remove all action. In the example, following the remove all action, the loaded stream XML files and available custom platforms are both displayed as empty.

```
STREAM XML:↵
Action: Remove All↵
↵
ACK↵
↵
STREAM XML:↵
Files: ↵
↵
STREAM SETTINGS:↵
Available Custom Platforms:↵
↵
```

Stream State Block

The stream state block provides the streaming status of the Web Presenter.

The Web Presenter server will send a stream state block update whenever there is a change to the Status field. Due to frequency of changes to Duration, Bitrate and Cache Used fields, these fields need to be polled by the client by requesting a Stream State block.

Block syntax

```
STREAM STATE:↵↵
Status: Idle↵↵
Bitrate: 161672↵↵
Duration: 00:00:00:00↵↵
Cache Used: 0↵↵
↵↵
```

Parameters

Key	Read/Write	Description	Valid Values
Status	Read only	The stream state of the Web Presenter, updated when the stream status changes	Idle Connecting Streaming Interrupted
Action	Write only	The Web Presenter stream state action.	Start Stop
Duration	Read only	The duration of the active stream	String in format of DD:HH:MM:SS
Bitrate	Read only	The bitrate of the active stream	Integer bits per second
Cache Used	Read only	The current usage of the streaming cache	Integer as a percentage

Starting Stream

The stream is started by providing a stream state block with start action.

```
STREAM STATE:↵↵
Action: Start↵↵
↵↵
ACK↵↵
↵↵
STREAM STATE:↵↵
Status: Connecting↵↵
↵↵
STREAM STATE:↵↵
Status: Streaming↵↵
↵↵
```

Stopping stream

The stream is stopped by providing a Stream State block with stop action.

```
STREAM STATE:↵↵
Action: Stop↵
↵
ACK↵
↵
STREAM STATE:↵↵
Status: Idle↵
↵
```

Audio Settings Block

The Audio Settings block contains the audio configuration for the connected Web Presenter.

Block syntax

This example shows the output for a connected Web Presenter. The stream settings prefixed with Current show the active audio settings and are writable. The stream settings prefixed by Available show the available audio settings for the device or platform and are read-only.

```
AUDIO SETTINGS:↵↵
Current Monitor Out Audio Source: Auto↵
Available Monitor Out Audio Sources: Auto, SDI In, Remote Source↵
↵
```

Parameters

Key	Read/Write	Description	Valid Values
Current Monitor Out Audio Source	Read/Write	The current audio source on the monitor output	Refer to the audio sources from the <i>Available Monitor Out Audio Sources</i> field
Available Monitor Out Audio Sources	Read only	The available audio sources that can be routed to the monitor output	Comma separated list of audio sources

Changing Audio Settings

The audio settings can be changed by providing an audio settings block. The following is an example of setting the monitor output audio source to remote.

```
AUDIO SETTINGS:↵↵
Current Monitor Out Audio Source: Remote Source↵
↵
ACK↵
↵
AUDIO SETTINGS:↵↵
Current Monitor Out Audio Source: Remote Source↵
↵
```

Shutdown Block

The Shutdown block provides power control of the Web Presenter. The Shutdown block is write-only and not presented in the preamble.

Parameters

Key	Read/Write	Description	Valid Values
Action	Write only	The Web Presenter shutdown action.	Reboot Factory Reset

Reboot

The Web Presenter can be rebooted by providing a Shutdown block with reboot action.

```
SHUTDOWN:↵
```

```
Action: Reboot↵
```

```
↵
```

```
ACK↵
```

```
↵
```

On reboot action, the Web Presenter server will be stopped and clients will be disconnected.

Factory Reset

The Web Presenter can be factory reset by providing a Shutdown block with factory reset action. On factory reset action, all settings are set to factory defaults.

```
SHUTDOWN:↵
```

```
Action: Factory Reset↵
```

```
↵
```

```
ACK↵
```

```
↵
```

Blackmagic Streaming XML Format

Overview

The Blackmagic Streaming XML allows users to specify streaming services in addition to the default services provided by the Web Presenter.

The Streaming XML can be loaded into the Web Presenter with Web Presenter Setup. Refer to the 'Using Web Presenter Setup' section earlier in this manual

The Streaming XML can also be loaded by copying the contents into the Stream XML block with the Blackmagic Web Presenter Ethernet Protocol.

The following is a minimal example of a Streaming XML file:

```
<?xml version="1.0" encoding="UTF-8"?>
<streaming>
  <service>
    <name>My Streaming Service</name>
    <servers>
      <server>
        <name>My Streaming Server</name>
        <url>rtmp://my.streaming-server.com/live</url>
      </server>
    </servers>
    <profiles>
      <profile>
        <name>My Streaming Quality</name>
        <config resolution="1080p" fps="60" codec="H264">
          <bitrate>7500000</bitrate>
        </config>
      </profile>
    </profiles>
  </service>
</streaming>
```

Streaming XML Definition

The Streaming XML file follows standard XML format and shall begin with XML declaration.

```
<?xml version="1.0" encoding="UTF-8"?>
```

Streaming Element

The Streaming XML file shall be contained by the <streaming> element. The <streaming> element will consist of 1 or more <service> child elements.

The following is an example of a <streaming> element block that defines 2 streaming services.

```
<streaming>
  <service>
    <name>Service 1</name>
    <!-- Streaming settings for "Service 1" -->
  </service>
  <service>
    <name>Service 2</name>
    <!-- Streaming settings for "Service 2" -->
  </service>
</streaming>
```

Service Element

The <service> element provides a description of the streaming service. If multiple streaming services are used, it is possible to define multiple <service> elements within each <streaming> element block.

The following is an example of a <service> element block in the Stream XML file.

```
<streaming>
  <service customizable-url="true">
    <name>My Streaming Service</name>
    <key>abc1-def2-ghi3-jkl4-mno5</key>
    <servers>
      <!-- Streaming server settings -->
    </servers>
    <profiles default="Streaming High">
      <!-- Streaming quality settings-->
    </profiles>
    <credentials>
      <!-- Streaming username and password settings -->
    </credentials>
  </service>
  <!-- <service> elements blocks for other streaming services -->
</streaming>
```

Attributes

Attribute	Optional/Required	Description
customizable-url	Optional	The service supports specifying custom URLs - supported = "true" or unsupported = "false" (default)

Child Elements

Element	Optional/Required	Description
<name>	Required	The name of the streaming service
<key>	Optional	The stream key for the streaming service
<servers>	Optional	The RTMP/SRT server settings of the streaming service (see below). May be omitted if customizable-url is true.
<profiles>	Required	The quality settings of the streaming service (see below)
<credentials>	Optional	The username and password of the streaming service (see below)

Servers Element

The <servers> element consists of 1 or more <server> child elements for defining the streaming server(s). The <servers> element is a required child of the <service> element. Defining multiple servers allows specifying localized and/or backup servers within a single XML description

The following is an example of a <servers> element block that defines a primary and secondary URL for the SRT server.

```
<service>
  ...
  <servers>
    <server group="Primary">
      <name>My Streaming Service Server</name>
      <url>srt://srt.my-streaming-service.com:2010</url>
      <srt-extensions>
        ...
      </srt-extensions>
    </server>
    <server group="Secondary">
      <name>My Streaming Service Backup Server</name>
      <url>srt://srt-backup.my-streaming-service.com:2010</url>
      <srt-extensions>
        ...
      </srt-extensions>
    </server>
    <!-- Additional <server> element blocks defining other
servers for streaming service -->
  </servers>
  ...
</service>
```

Attributes

Attribute	Optional/Required	Description
group	Optional	The logical grouping for the server

Child Elements

Element	Optional/Required	Description
<name>	Required	The name of the RTMP/SRT streaming server
<url>	Required	The URL of the RTMP/SRT streaming server
<srt-extensions>	Optional	Extended service block specific to SRT streaming server (see below)

SRT Extensions Element

The <srt-extensions> element consists of 1 or more child elements that define SRT specific parameters.

The following is an example of a <srt-extensions> element block for a primary stream identifier.

```
<service>
  ...
  <servers>
    <server group="Primary">
      ...
      <srt-extensions>
        <stream-id>
          <item key="copy" value="0"/>
        </stream-id>
      </srt-extensions>
    </server>
  </servers>
  ...
</service>
```

Child Elements

Element	Optional/Required	Description
<stream-id>	Required	Provides element with custom parameters for the stream ID. Each child element of stream-id has 1 or more item elements with a key/value pair.

Profiles Element

The <profiles> element consists of 1 or more <profile> child elements that define streaming quality. The <profiles> element is a required child of the <service> element. Defining multiple profiles allows specifying custom bitrates for different streaming qualities.

The following is an example of a <profiles> element block that defines 3 profiles.

```
<service>
  ...
  <profiles default="Streaming High">
    <profile>
      <name>Streaming High</name>
      <!-- Define <config> elements to specify target
bitrates for Streaming High profile -->
    </profile>
    <profile>
      <name>Streaming Medium</name>
      <!-- Define <config> elements to specify target
bitrates for Streaming Medium profile -->
    </profile>
  </profiles>
  ...
</service>
```

Attributes

Attribute	Optional/Required	Description
default	Optional	The name of the default profile

Child Elements

Element	Optional/Required	Description
<name>	Required	The name of the profile
<config>	Required	Video mode dependent quality settings for profile (see below)

Config Element

The <config> element defines a mapping between the video resolution and frame rate and the target bitrate for the quality level. The <config> element is a child of the <profile> element.

The following is an example of a <config> element block for setting the target bitrate for a high quality stream with 720p60 and 1080p60 video inputs.

```
<profile>
  <name>Streaming High</name>
  <config resolution="720p" fps="60" codec="H264">
    <bitrate>6000000</bitrate>
    <audio-bitrate>128000</audio-bitrate>
  </config>
  <config resolution="1080p" fps="60" codec="H264">
    <bitrate>8000000</bitrate>
    <audio-bitrate>128000</audio-bitrate>
  </config>
  <!-- <config> elements for other resolutions and frame rates -->
</profile>
```

Attributes

Attribute	Optional/Required	Description
resolution	Required	The resolution of the streaming video mode
fps	Required	The frame rate of the streaming video mode (frames per second)
codec	Optional	The codec for encoding the streaming video - "H264" (default) or "H265"

Child Elements

Element	Optional/Required	Description
<bitrate>	Required	The target bitrate of the streaming video (bits per second)
<audio-bitrate>	Optional	The target bitrate of the streaming audio (bits per second)

The supported streaming quality bitrates can be found in section `Using Web Presenter Setup` section earlier in this manual.

TIP For each <config> element block, choose a maximum resolution and fps to cover all video modes for the target bitrate. For example, defining a <config> element with resolution="1080p" and fps = "30" will apply for video modes 1080p23.98, 1080p24, 1080p25, 1080p29.97 and 1080p30.

For audio bitrate, only 128 Kb/s is supported.

Credentials Element

The <credentials> element allows specifying an RTMP session username and password if required by the service. The <credentials> element is an optional child to service element.

The following is an example of a <credentials> element block that defines a username and password for the streaming service.

```
<service>
  ...
  <credentials>
    <username>myusername</username>
    <password>abcd1234</password>
  </credentials>
  ...
</service>
```

Child Elements

Element	Optional/Required	Description
<username>	Required	RTMP session username
<password>	Required	RTMP/SRT session password

ヘルプ

ヘルプライン

すぐに情報が必要な方は、Blackmagic Designオンラインサポートページで、Blackmagic Web Presenterの最新サポート情報を確認できます。

Blackmagic Design オンラインサポートページ

最新のマニュアルは、Blackmagic Designサポートセンターで確認できます。

www.blackmagicdesign.com/jp/support

Blackmagic Designフォーラム

弊社ウェブサイトのBlackmagic Designフォーラムは、様々な情報やクリエイティブなアイデアを共有できる有益なリソースです。経験豊富なユーザーやBlackmagic Designスタッフによって、すでに多くの問題の解決策が公開されていますので、このフォーラムを参考にすることで、現在の問題をすばやく解決できることがあります。ぜひご利用ください。Blackmagicフォーラムには、<http://forum.blackmagicdesign.com>からアクセスできます。

Blackmagic Design サポートへ連絡

サポートページやフォーラムで必要な情報を得られなかった場合は、サポートページの「メールを送信」ボタンを使用して、サポートのリクエストをメール送信してください。あるいは、サポートページの「お住まいの地域のサポートオフィス」をクリックして、お住まいの地域のBlackmagic Designサポートオフィスに電話でお問い合わせください。

規制に関する警告



欧州連合内での電気機器および電子機器の廃棄処分

製品に記載されている記号は、当該の機器を他の廃棄物と共に処分してはならないことを示しています。機器を廃棄するには、必ずリサイクルのために指定の回収場所に引き渡してください。機器の廃棄において個別回収とリサイクルが行われることで、天然資源の保護につながり、健康と環境を守る方法でリサイクルが確実に行われるようになります。廃棄する機器のリサイクルのための回収場所に関しては、お住まいの地方自治体のリサイクル部門、または製品を購入した販売業者にご連絡ください。



この機器は、FCC規定の第15部に準拠し、クラスAデジタル機器の制限に適合していることが確認されています。これらの制限は、商用環境で機器を使用している場合に有害な干渉に対する妥当な保護を提供するためのものです。この機器は無線周波エネルギーを生成、使用、放出する可能性があります。また、指示に従ってインストールおよび使用しない場合、無線通信に有害な干渉を引き起こす恐れがあります。住宅地域で当製品を使用すると有害な干渉を引き起こす可能性があり、その場合はユーザーが自己責任で干渉に対処する必要があります。

動作は次の2つを条件とします：

- 1 本機は、有害な干渉を起こさない。
- 2 本機は希望しない動作を発生しかねない干渉を含む、いかなる受信干渉も受け入れる必要がある。



R-R-BMD-20201201001
R-R-BMD-20201201002



ISED Canadaステートメント

本機は、カナダのクラスAデジタル機器の規格に準拠しています。

本機のいかなる改造、あるいは目的の用途以外での使用は、これらの規格への順守を無効にすることがあります。

HDMIインターフェースへの接続は、必ず高品質のシールドHDMIケーブルを使用する必要があります。

本機は、商用環境で目的の用途に順守した使用においてテストを行なっています。非商用環境で使用された場合、無線妨害を引き起こす可能性があります。

安全情報

必ず保護接地のあるコンセントに接続してください。

感電のリスクを減らすため、水が跳ねたり、滴るような場所には置かないでください。

この機器は、周囲温度が最高40°Cまでの熱帯地区での使用に対応しています。

気温-20°Cから60°C、相対湿度の0%から90%（結露なし）の場所に保管してください。

通気が妨げられないように、当製品の周囲は通気に十分なスペースを開けるようにしてください。

ラックマウントする場合は、隣接する機器により通気が妨げられないようにしてください。

ユーザーが保守できる部品はありません。サービスに関しては、お近くのBlackmagic Designのサービスセンターにお問い合わせください。



海拔2000m以上では使用しないでください。

カリフォルニア州ステートメント

この製品のユーザーは、プラスチック部品内の微量の多臭素化ビフェニルなどの化学物質にさらされる可能性があります。カリフォルニア州は、多臭素化ビフェニルは発がん性があり、先天異常や生殖機能へ危害を及ぼす物質であると認識しています。

詳細は、以下のウェブサイトをご確認ください。www.P65Warnings.ca.gov

保証

36ヶ月限定保証

Blackmagic Designは、お買い上げの日から36ヶ月間、Blackmagic Web Presenterの部品および仕上がりについて瑕疵がないことを保証します。しかし、コネクタ、ケーブル、光ファイバーモジュール、ヒューズ、バッテリーについては、それらの部品および仕上がりについて瑕疵がないことに対する保証は12ヶ月間です。この保証期間内に製品に瑕疵が見つかった場合、Blackmagic Designは弊社の裁量において部品代および人件費無料で該当製品の修理、あるいは製品の交換のいずれかで対応いたします。

この保証に基づいたサービスを受ける際、お客様は必ず保証期限終了前にBlackmagic Designに瑕疵を通知し、保証サービスの手続きを行ってください。お客様の責任において不良品を梱包し、Blackmagic Designが指定するサポートセンターへ送料前払で送付いただきますようお願い致します。理由の如何を問わず、Blackmagic Designへの製品返送のための送料、保険、関税、税金、その他すべての費用はお客様の自己負担となります。

不適切な使用、または不十分なメンテナンスや取扱いによる不具合、故障、損傷に対しては、この保証は適用されません。Blackmagic Designはこの保証で、以下に関してサービス提供義務を負わないものとします。a) 製品のインストールや修理、サービスを行うBlackmagic Design販売代理人以外の者によって生じた損傷の修理、b) 不適切な使用や互換性のない機器への接続によって生じた損傷の修理、c) Blackmagic Designの部品や供給品ではない物を使用して生じたすべての損傷や故障の修理、d) 改造や他製品との統合により時間増加や製品の機能低下が生じた場合のサービス。この保証はBlackmagic Designが保証するもので、明示または黙示を問わず他の保証すべてに代わるものです。Blackmagic Designとその販売社は、商品性と特定目的に対する適合性のあらゆる黙示保証を拒否します。Blackmagic Designの不良品の修理あるいは交換の責任が、特別に、間接的、偶発的、または結果的に生じる損害に対して、Blackmagic Designあるいは販売社がそのような損害の可能性についての事前通知を得ているか否かに関わらず、お客様に提供される完全唯一の救済手段となります。Blackmagic Designはお客様による機器のあらゆる不法使用に対して責任を負いません。Blackmagic Designは本製品の使用により生じるあらゆる損害に対して責任を負いません。使用者は自己の責任において本製品を使用するものとします。

© Copyright 2023 Blackmagic Design 著作権所有、無断複写・転載を禁じます。「Blackmagic Design」、「DeckLink」、「HDLink」、「Workgroup Videohub」、「Multibridge Pro」、「Multibridge Extreme」、「Intensity」、「Leading the creative video revolution」は、米国ならびにその他諸国での登録商標です。その他の企業名ならびに製品名全てはそれぞれ関連する会社の登録商標である可能性があります。

ThunderboltおよびThunderboltのロゴは、米国またはその他諸国のIntel Corporationの登録商標です。

Blackmagic Web Presenter





Bienvenue

Nous vous remercions d'avoir fait l'acquisition d'un Blackmagic Web Presenter.

Le Blackmagic Web Presenter se branche directement aux équipements SDI, convertit le signal en H.264 et vous permet de streamer sur des plateformes de streaming populaires, telles que YouTube Live, Facebook Live et Twitch. Vous pouvez également transmettre de la vidéo de qualité broadcast point à point à l'aide de l'ATEM Streaming Bridge en option. Ainsi, il est facile de transmettre de la vidéo professionnelle à distance via Internet.

Ce manuel d'utilisation explique comment mettre en route le Blackmagic Web Presenter et utiliser toutes les fonctionnalités et les commandes. Il décrit par exemple la façon de configurer l'appareil pour YouTube Live, Facebook Live, Twitch, Zoom, Skype et autres.

Consultez notre page d'assistance sur www.blackmagicdesign.com/fr pour obtenir la dernière version du manuel et les mises à jour du logiciel interne du Blackmagic Web Presenter. Enfin, veuillez enregistrer votre équipement lors du téléchargement du logiciel afin que nous puissions vous tenir informé des mises à jour.

Nous souhaitons continuer à améliorer nos produits, n'hésitez donc pas à nous faire part de vos commentaires !

A cursive signature in black ink that reads "Grant Petty". The signature is fluid and elegant, with a long, sweeping underline.

Grant Petty

PDG de Blackmagic Design

Sommaire

Mise en route	111
Utiliser le panneau avant du Web Presenter	114
Écran LCD	115
Utiliser la sortie de monitoring	116
Utiliser le Web Presenter Setup	121
Onglet Live stream (stream en direct)	122
Onglet Setup (réglages)	125
Network Settings (Paramètres du réseau)	126
Régler le partage de connexion Internet pour le streaming direct	126
Streamer à l'aide de votre smartphone	127
Utiliser le Blackmagic Web Presenter comme une webcam	127
Configurer Open Broadcaster	127
Créer des liens vidéo avec l'ATEM Streaming Bridge	130
Créer le fichier XML	131
Exporter le fichier XML	131
Tally, réseau d'ordres et contrôle caméra	132
Connecter la URSA Broadcast G2	133
Blackmagic Universal Rack Shelf	134
Contenu	134
Installer un appareil sur l'Universal Rack Shelf	135
Fixer une plaque d'obturation de 1/6	135
Fixer la plaque d'obturation latérale de 1/3 de largeur	135
Mise à jour du logiciel interne	136
Developer Information	137
Blackmagic Web Presenter Ethernet Protocol	137
Protocol Blocks	139
Blackmagic Streaming XML Format	150
Overview	150
Streaming XML Definition	150
Assistance	157
Avis réglementaires	158
Informations de sécurité	159
Garantie	160

Mise en route

Il est très facile de mettre en route le Blackmagic Web Presenter ! Il suffit de connecter l'alimentation ainsi qu'une source vidéo et audio, puis de connecter l'appareil à votre ordinateur et à Internet.

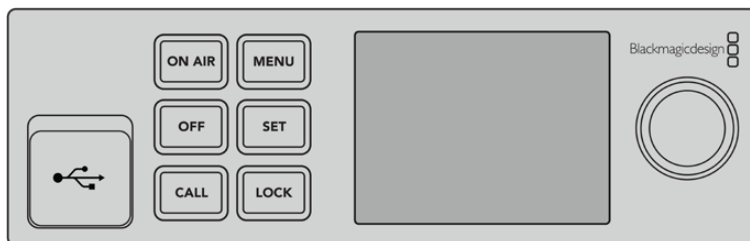

Panneau avant du Blackmagic Web Presenter

Connecter l'alimentation

Branchez un câble d'alimentation CEI standard à l'entrée d'alimentation située sur le panneau arrière du Blackmagic Web Presenter.

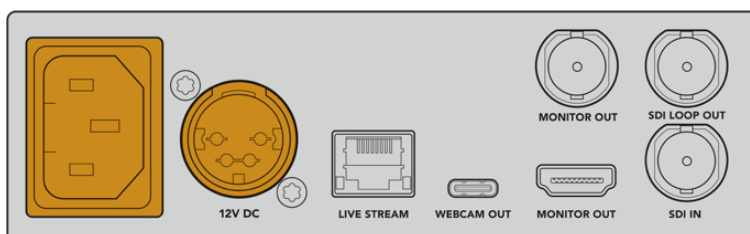

Le Blackmagic Web Presenter peut être alimenté à l'aide de l'entrée d'alimentation CEI ou DC 12V.

Le Web Presenter possède également une entrée d'alimentation DC 12V supplémentaire. Vous pouvez utiliser cette entrée si vous souhaitez connecter une alimentation externe ou redondante, comme un système d'alimentation sans coupure ou une batterie externe 12V.

Connecter une source vidéo et audio

Branchez votre source vidéo à l'entrée SDI du Blackmagic Web Presenter. Une fois la vidéo connectée, elle s'affichera sur l'écran LCD intégré du Web Presenter. L'audio est intégré à la vidéo sur les signaux vidéo SDI, ce qui se confirme en observant les indicateurs audio sur l'écran LCD.

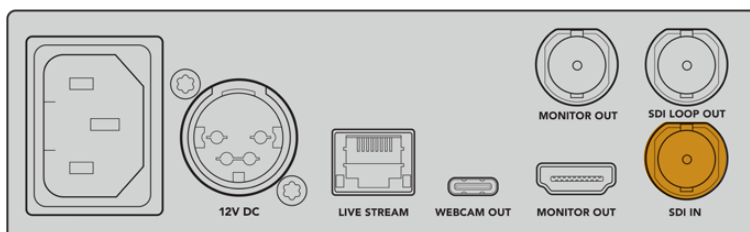

Connectez la vidéo à l'entrée SDI du Blackmagic Web Presenter.

Le Blackmagic Web Presenter prend en charge le 12G-SDI et commute automatiquement entre les normes HD et Ultra HD jusqu'à 2160p60 lorsque l'entrée vidéo change. Le Blackmagic Web Presenter 4K peut streamer en Ultra HD, tandis que le Blackmagic Web Presenter HD prend en charge presque tous les signaux vidéo et les down-convertit en 1080p.

Connecter un moniteur

Branchez votre télévision HDMI ou moniteur SDI à l'une des sorties de monitoring. Cela vous permet de visionner votre émission et d'observer les informations d'état importantes qui sont constamment mises à jour d'après le stream vidéo. Pour plus d'informations sur la façon d'utiliser la sortie de monitoring, consultez la section « Utiliser la sortie de monitoring » de ce manuel.

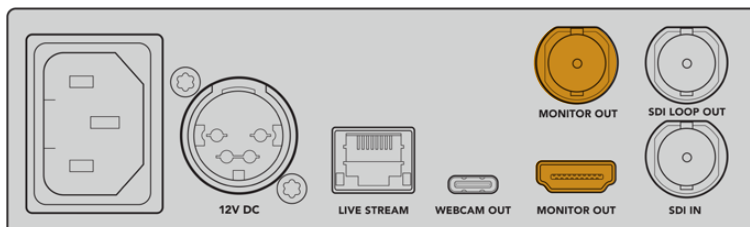

Connectez un moniteur à la sortie de monitoring du Web Presenter.

Connecter l'appareil à un ordinateur via USB

Connectez le Web Presenter à votre ordinateur via le port USB-C situé sur le panneau avant ou arrière. Ces ports USB permettent de mettre à jour l'appareil et de le configurer avec l'utilitaire Blackmagic Web Presenter Setup. Une fois que vous avez configuré le Web Presenter pour la première fois, vous pouvez déconnecter l'appareil de l'ordinateur.

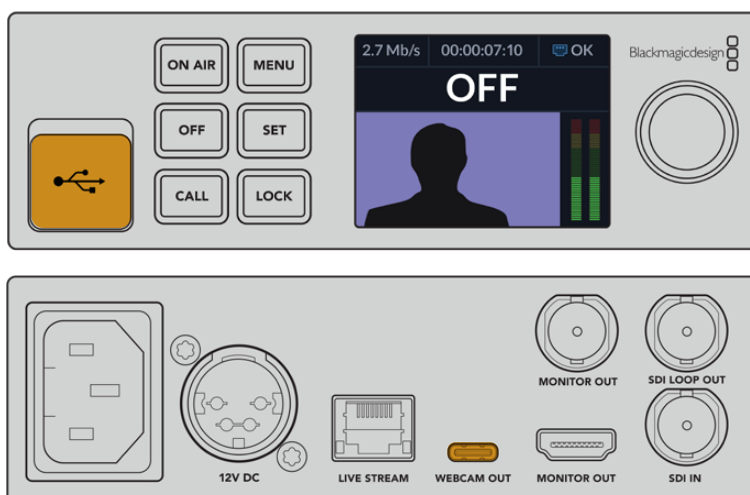

Connectez le Blackmagic Web Presenter à votre ordinateur via le port USB situé sur le panneau avant ou arrière.

Connecter l'appareil à Internet

Connectez le Blackmagic Web Presenter à Internet en branchant un câble réseau du port Ethernet Live stream à un routeur Internet ou un commutateur réseau.

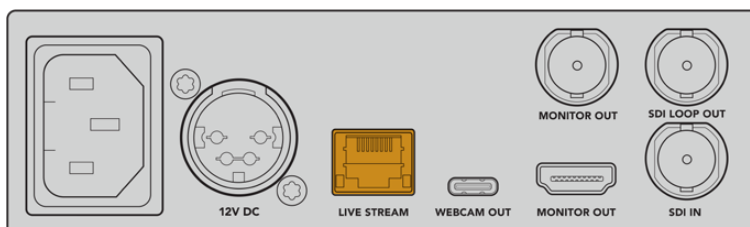

Connectez le Blackmagic Web Presenter à votre réseau via le port Ethernet situé sur le panneau arrière.

Configurer un stream en direct

Vous pouvez maintenant configurer votre Web Presenter pour streamer via n'importe quelle plateforme de streaming, telle que YouTube Live, Facebook Live, Twitch et autres. Dans cet exemple, nous allons utiliser YouTube Live.

- 1 Copiez votre clé de stream depuis votre compte YouTube Studio.
- 2 Téléchargez l'utilitaire Blackmagic Web Presenter Setup sur www.blackmagicdesign.com/fr/support et installez-le sur votre ordinateur. Ce logiciel vous permet de configurer les paramètres de streaming pour la première fois.
- 3 Lancez l'utilitaire Blackmagic Web Presenter Setup et allez sur la page **Live stream**.
- 4 Réglez la plateforme sur YouTube et le serveur sur **Primary**. Collez la clé de stream YouTube dans le champ **Key** et sélectionnez une qualité pour le streaming. Cliquez sur **Save**.
- 5 Vous êtes maintenant prêt à streamer partout dans le monde ! Cliquez sur le bouton **On air** ou appuyez sur le bouton **On air** du panneau avant de l'appareil. Une fois votre production terminée, appuyez sur le bouton **Off** pour arrêter la diffusion.

Utiliser le protocole de streaming SRT

Le protocole Secure Reliable Transport (SRT) offre une latence de streaming plus faible que le RTMP. Le SRT est également plus sécurisé car il utilise une phrase de passe, qui fonctionne comme une clé de chiffrement.

Lorsque vous sélectionnez la version du protocole SRT de votre service de streaming, copiez la phrase de passe et la clé de stream depuis votre compte de streaming et collez-les dans les champs **Key** et **Passphrase** de l'utilitaire Blackmagic Web Presenter Setup.

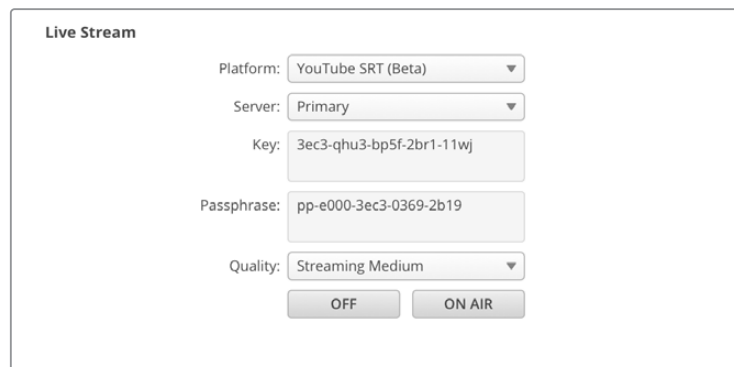

The screenshot shows the 'Live Stream' configuration window. It contains the following fields and controls:

- Platform:** A dropdown menu set to 'YouTube SRT (Beta)'. The text 'Platform:' is to the left of the dropdown.
- Server:** A dropdown menu set to 'Primary'. The text 'Server:' is to the left of the dropdown.
- Key:** A text input field containing the value '3ec3-qhu3-bp5f-2br1-11wj'. The text 'Key:' is to the left of the field.
- Passphrase:** A text input field containing the value 'pp-e000-3ec3-0369-2b19'. The text 'Passphrase:' is to the left of the field.
- Quality:** A dropdown menu set to 'Streaming Medium'. The text 'Quality:' is to the left of the dropdown.
- At the bottom, there are two buttons: 'OFF' and 'ON AIR'.

Collez votre phrase de passe dans le champ **Passphrase** de l'utilitaire

Le protocole RTMP ou SRT, ainsi que le codec H.264 ou H.265, peuvent être modifiés dans le fichier XML par les diffuseurs expérimentés techniquement qui souhaitent personnaliser leurs paramètres de streaming. Pour plus d'informations, veuillez consulter la section « Blackmagic Streaming XML Format ».

Utiliser le panneau avant du Web Presenter

Utilisez les commandes du panneau avant du Blackmagic Web Presenter pour démarrer/arrêter le streaming et pour modifier les paramètres.

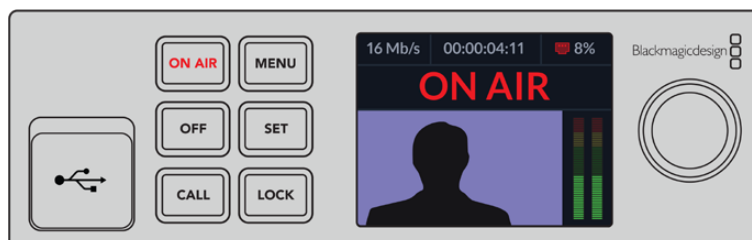

On air – Pour démarrer le streaming, il suffit d'appuyer sur le bouton **On air**. Le bouton s'allumera en rouge pendant le direct.



Si le bouton clignote, le stream en direct n'a pas démarré ou s'est arrêté de manière inattendue. C'est peut-être dû à un problème avec votre connexion Internet ou les paramètres de streaming. Il vous faudra donc vérifier que votre connexion Internet fonctionne et que les paramètres de streaming sont corrects.

Off - Pour arrêter le streaming, appuyez sur le bouton **Off**.

Menu - Appuyez sur le bouton **Menu** pour ouvrir les paramètres sur l'écran LCD.

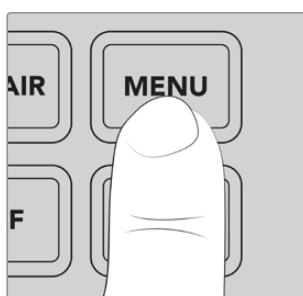

Pour modifier un paramètre :

- 1 Faites tourner la molette pour sélectionner le paramètre que vous souhaitez modifier et appuyez sur **Set**.

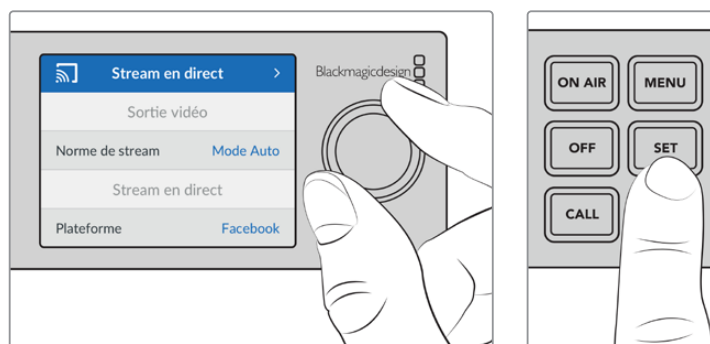

- 2 Utilisez la molette pour modifier le paramètre.
- 3 Appuyez à nouveau sur **Set** pour confirmer le changement.

Appuyez sur le bouton Menu pour revenir en arrière et accéder à l'écran d'accueil.

Call - Cette fonction sera disponible lors d'une future mise à jour.

Lock - Pour verrouiller le panneau, appuyez et maintenez ce bouton enfoncé pendant une seconde. Cela désactive les boutons afin d'éviter l'arrêt d'un stream ou un passage en direct accidentel. Ce bouton s'allume en rouge lorsqu'il est actif.

Appuyez et maintenez ce bouton enfoncé pendant deux secondes pour déverrouiller le panneau.

Écran LCD

L'écran d'accueil est la première chose que vous verrez lorsque vous allumerez le Web Presenter. Il affiche des informations importantes, notamment :

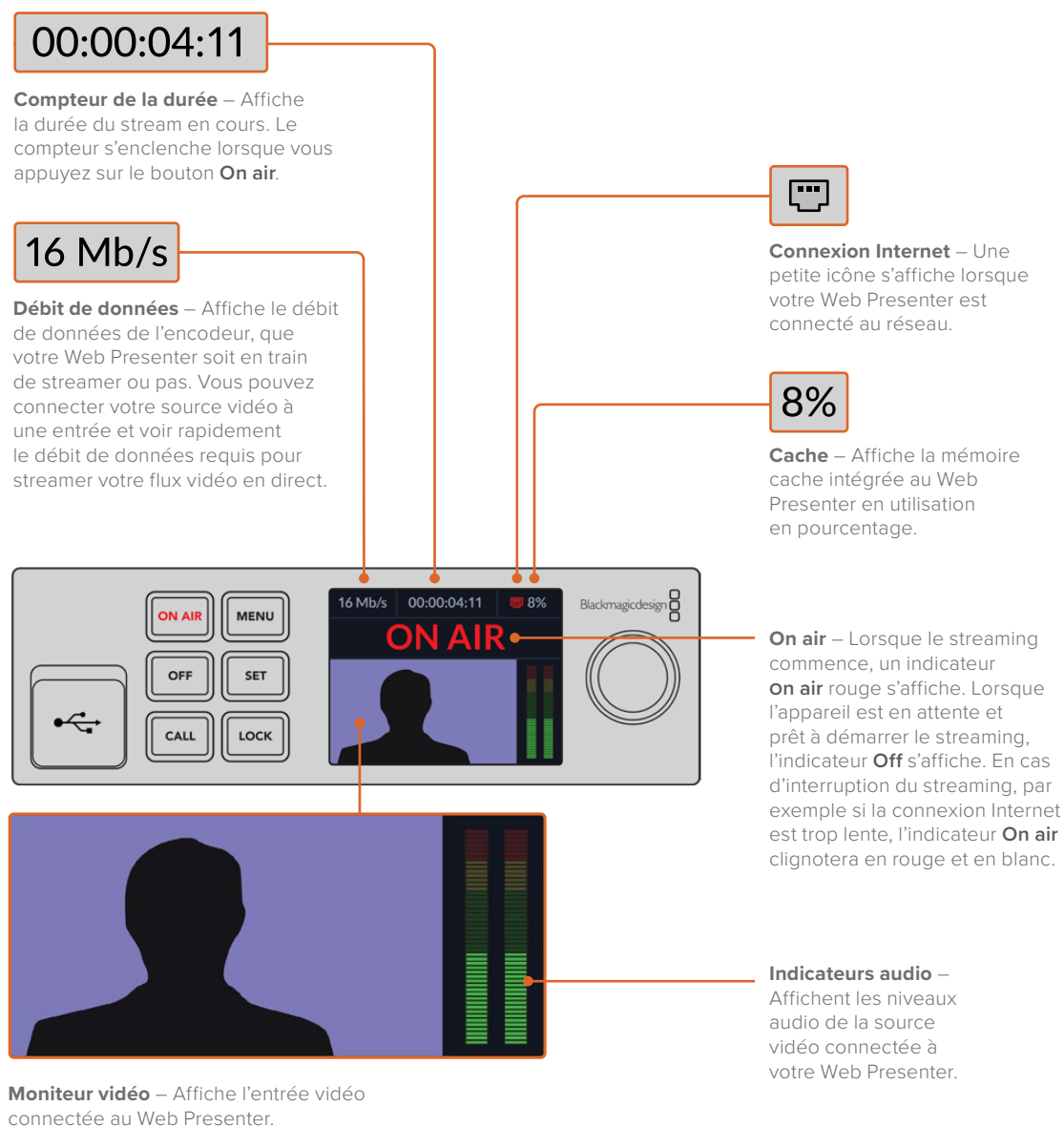

Icônes de connexion Internet



Une icône Ethernet bleue s'affiche lorsqu'un câble Ethernet est connecté et que la connexion Ethernet sera utilisée pour le streaming.



Une icône Ethernet rouge s'affiche lorsque le signal est à l'antenne et que le streaming est effectué via Ethernet.



Une icône smartphone bleue s'affiche lorsque la connexion Internet d'un smartphone connecté sera utilisée pour le streaming.



Une icône smartphone rouge s'affiche lorsque le signal est à l'antenne et que le streaming est effectué via un smartphone connecté.

CONSEIL Si aucune icône n'est affichée, votre Web Presenter n'est pas connecté au réseau.

Utiliser la sortie de monitoring

La sortie de monitoring vous permet de visionner l'entrée vidéo, les niveaux audio, l'état de l'indicateur On air, le débit de données et les niveaux du cache, ainsi que des informations techniques sur l'entrée SDI.



La sortie de monitoring du Blackmagic Web Presenter fournit de nombreuses informations dont le débit de données et l'état du cache.

L'affichage de la sortie de monitoring comprend 8 zones. Vous trouverez ci-dessous une description de chaque zone et des informations qu'elle affiche.

Affichage de l'entrée

La zone principale affiche l'entrée vidéo de la source vidéo SDI connectée.



Indicateur On air

Avant le streaming, l'indicateur affichera **Off** pour vous informer que le Web Presenter est en attente et prêt à diffuser. Lorsque le streaming commence, l'indicateur affiche l'état **On air** en rouge, jusqu'à l'arrêt du streaming.



Le compteur de la durée se trouve sous l'indicateur On air. Lorsque vous appuyez sur le bouton On air du Web Presenter, le compteur de la durée s'enclenche.

Si votre Web Presenter est hors antenne, mais qu'il streame via un smartphone connecté, une icône smartphone bleue s'affiche au coin de l'indicateur **Off**. L'icône smartphone s'allume en rouge lors du passage à l'antenne.

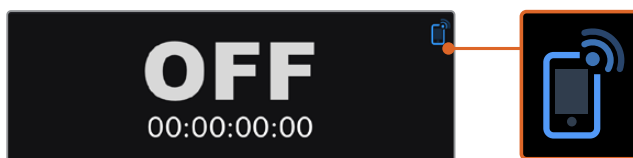

Stream en direct

La zone du stream en direct affiche des informations sur les paramètres de ce dernier, dont la plateforme de streaming, le serveur et le protocole. Elle affiche également la résolution du stream et les paramètres de qualité.

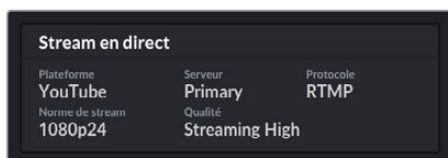

Entrée vidéo

Les 5 mini viewers en haut de la zone de l'entrée vidéo affichent les 6 dernières secondes de votre stream en direct. Chaque mini viewer représente 1,2 seconde de temps de streaming.

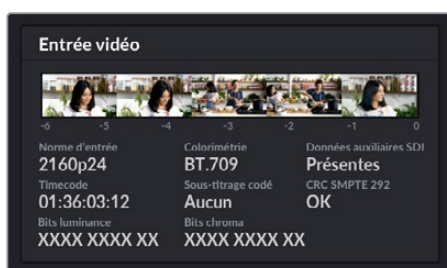

Au-dessous des mini viewers, vous trouverez des informations techniques sur la source d'entrée vidéo connectée à l'entrée SDI du Web Presenter.

Norme d'entrée	Affiche la résolution et la fréquence d'images de l'entrée vidéo SDI. Le Web Presenter supporte les formats jusqu'à 2160p60.
Colorimétrie	Affiche l'espace colorimétrique de l'entrée vidéo SDI. Le Web Presenter supporte les espaces Rec.601, Rec.709 et Rec.2020.
Données auxiliaires SDI	Les données auxiliaires sont des données acheminées au sein de l'entrée vidéo SDI en plus de la vidéo. Elles incluent l'audio intégré, le timecode et le sous-titrage codé. Si votre entrée SDI comprend des données auxiliaires, la mention Présentes s'affichera.
Timecode	Affiche le timecode de la source d'entrée vidéo SDI.
Sous-titrage codé	Si votre entrée vidéo SDI comprend le sous-titrage codé, son format s'affichera ici. Les formats CEA-608 et CEA-708 sont supportés.
SMPTE 292 CRC	C'est une fonction de vérification des erreurs pour la vidéo SDI. Si votre Web Presenter détecte un problème dans l'entrée vidéo SDI, une erreur s'affichera. Les erreurs CRC sont en général causées par des câbles SDI défectueux ou par un câble trop long.
Bits luminance Y et Bits chroma	<p>Les indicateurs Bits luminance Y et Bits chroma affichent l'activité du signal d'entrée vidéo SDI. Chaque lettre représente l'état d'un bit du signal vidéo.</p> <p>X – Un X indique un bit en constant changement. L – Un bit bas. H – Un bit haut.</p> <p>Le décalage SDI est soustrait pour faciliter la compréhension. Par exemple, tous les bits sont bas lorsque la vidéo est noire.</p> <p>En général, les 10 bits de votre entrée vidéo SDI afficheront la mention X. Cela signifie que tous les bits de votre stream vidéo changent constamment. Si votre entrée SDI est une vidéo 8 bits, les deux bits les plus à droite seront toujours bas (L), car ils ne contiennent pas de données. Si un bit reste sur L ou sur H, et que vous vous attendiez à ce qu'il soit sur X, cela indique un « bit bloqué » qui est peut-être causé par un défaut dans la vidéo en amont.</p>

Entrée audio

La forme d'onde audio en haut de la zone Entrée audio affiche les informations audio des 6 dernières secondes de votre stream en direct. Elle est continuellement mise à jour et se défile de droite à gauche.

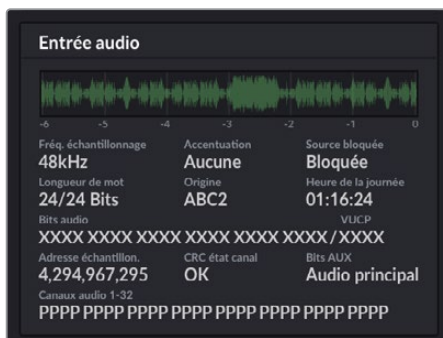

Au-dessous de l'affichage de la forme d'onde, vous trouverez des informations techniques détaillées concernant l'entrée audio.

Fréquence d'échantillonnage	Affiche la fréquence d'échantillonnage de l'audio intégré à l'entrée SDI.
Accentuation	Indique si l'option d'accentuation de la source audio est activée.
Source bloquée	Indique si la fréquence de la source audio est verrouillée sur une source de référence externe.
Longueur de mot	Affiche la profondeur de bits de l'audio intégré à l'entrée SDI.
Origine	Ces quatre caractères indiquent l'origine du canal.
Heure de la journée	Timecode continu.
Bits audio	Affiche l'activité des bits des échantillons audio intégrés à la connexion SDI. Même si l'état du canal audio indique que vous avez 16, 20 ou 24 bits audio, l'activité des bits audio le confirmera.
VUCP	Lorsque vous lisez les bits VUCP de gauche à droite : le bit V signifie Valid (valide), le U signifie User (utilisateur), le C signifie Channel status (état du canal) et le P signifie Parity (parité). Ce champ ressemble à celui de Bits audio.
Adresse d'échantillonnage	Compteur d'échantillons audio.
Bits AUX	Indique si des bits AUX sont utilisés pour l'audio principal.
Canaux audio 1-32	Chaque chiffre représente un canal audio intégré à l'entrée SDI. Un P indique qu'un canal audio est utilisé et un - signifie qu'il n'y pas d'audio sur ce canal.

Affichage du débit de données

L'affichage du débit de données indique le débit de données de l'encodeur durant les 60 dernières secondes. Le débit de données est mesuré en mégabits par seconde. Cet indicateur est tout le temps actif, même hors antenne, afin que vous puissiez mesurer votre bande passante avant le direct.

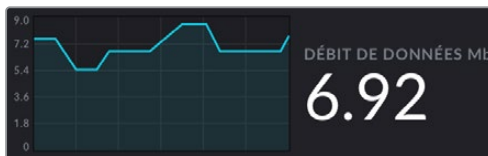

Affichage du cache

L'affichage du cache indique la mémoire tampon intégrée du Web Presenter en pourcentage et le graphique indique la quantité utilisée durant les 60 dernières secondes. Le cache est une petite mémoire interne qui enregistre et lit en continu la sortie programme. Il agit en mémoire de secours si le débit de données du streaming est trop bas et qu'il n'est plus capable de traiter la vidéo.

Le débit Internet peut être aléatoire, car il dépend principalement de l'activité du réseau ou de la force du signal sans fil. Si le débit de diffusion diminue, les données mises en tampon vont augmenter en conséquence. Si le débit Internet devient trop bas pour supporter le streaming, le cache va se remplir avec les images vidéo pour compenser. Cependant, une fois le cache rempli à 100 %, le streaming sera compromis. Il faut donc éviter d'atteindre la capacité maximum du cache. Vous pouvez effectuer un test en connectant un flux vidéo et en observant l'affichage du cache sur la sortie de monitoring sans démarrer le stream. Si le cache s'approche fréquemment de 100 %, choisissez une qualité de streaming plus basse.

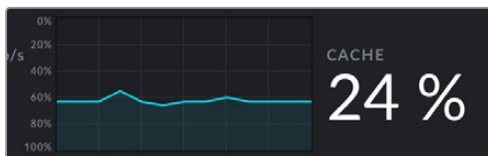

Indicateurs audio

Vous pouvez visionner les niveaux de votre source audio à l'aide des indicateurs audio. Ils peuvent être réglés sur des niveaux PPM ou VU dans les menus de configuration du Web Presenter. Si vos niveaux audio sont trop élevés, les indicateurs s'allumeront en rouge. Le cas échéant, il se peut que l'audio de votre stream en direct soit distordu ou écrêté. Idéalement, essayez de maintenir l'audio vers le haut de la section verte et occasionnellement dans la section jaune.

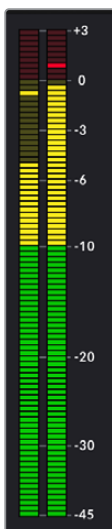

Utiliser le Web Presenter Setup

Lorsque votre Blackmagic Web Presenter est connecté à un réseau, n'importe quel ordinateur connecté au même réseau peut être utilisé pour contrôler le Web Presenter à distance. Avec le Blackmagic Web Presenter Setup, vous pouvez accéder aux mêmes commandes et paramètres disponibles sur le panneau avant de l'appareil.

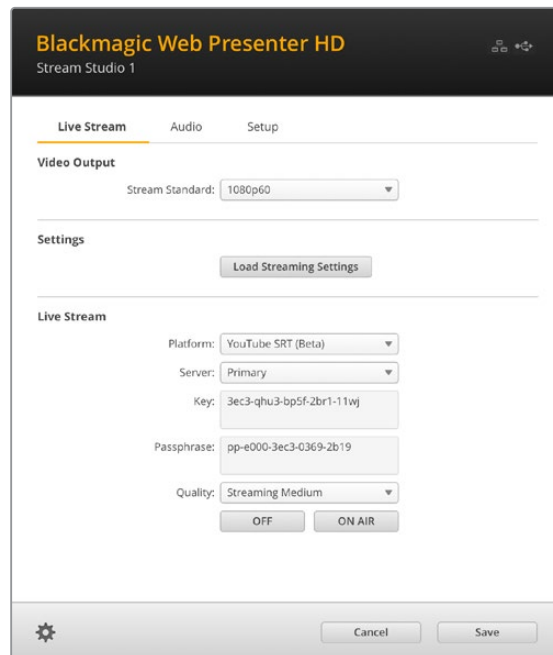
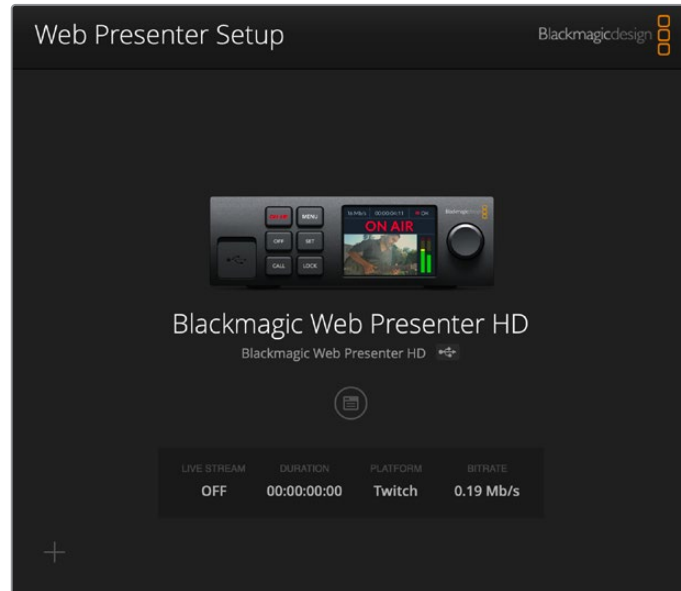

Onglet Live stream (stream en direct)

Video output (sortie vidéo)

Stream standard

Cliquez sur le menu de la norme de stream pour sélectionner les paramètres de résolution vidéo pour votre stream. Vos choix s'étendent de 720p25 à 1080p60 ou 2160p60 selon le modèle de Web Presenter que vous utilisez.

Settings (réglages)

Si vous avez personnalisé vos paramètres de streaming, par exemple avec un fichier XML depuis un Blackmagic ATEM Streaming Bridge, vous pouvez les importer en cliquant sur le bouton **Load streaming settings**.

Pour plus d'informations sur la personnalisation des paramètres et la connexion avec l'ATEM Streaming Bridge, veuillez consulter la section « Créer des liens vidéo avec l'ATEM Streaming Bridge » de ce manuel.

Live stream (stream en direct)

Platform

Cliquez sur ce menu et sélectionnez la plateforme de streaming pour votre diffusion. Vous avez le choix entre YouTube, Facebook et Twitch. Si vous avez importé des paramètres de streaming personnalisés, ils apparaîtront également dans la liste de ce menu.

Pour streamer sur une URL personnalisée, sélectionnez une option dans le menu **Platform**. Depuis le Web Presenter 4K, vous pouvez choisir de streamer sur une URL personnalisée en H.264 ou H.265, et uniquement en H.264 depuis le Web Presenter HD.

Server

Sélectionnez le serveur le plus proche de vous depuis la liste. La liste des serveurs varie selon la plateforme de streaming que vous avez choisie.

Si vous streamez sur Instagram, Microsoft Teams ou une URL personnalisée, la liste des serveurs sera un champ modifiable. Entrez l'URL assignée par votre compte de plateforme de streaming ou les détails de l'URL.

Key

Entrez la clé de stream qui a été assignée à votre diffusion par votre plateforme de streaming.

Passphrase

Si vous utilisez un service de streaming avec le protocole SRT, saisissez la phrase de passe assignée par votre compte de plateforme de streaming.

Quality

Sélectionnez la qualité de streaming pour la HD ou la 4K selon le modèle de Web Presenter que vous utilisez.

H.264	
HD	4K
HyperDeck High 45 to 70 Mb/s	HyperDeck High 95 to 220 Mb/s
HyperDeck Medium 25 to 45 Mb/s	HyperDeck Medium 66 to 150 Mb/s
HyperDeck Low 12 to 20 Mb/s	HyperDeck Low 38 to 80 Mb/s
Streaming High 6 to 9 Mb/s	Streaming High 34 to 51 Mb/s
Streaming Medium 4.5 to 7 Mb/s	Streaming Medium 23 to 35 Mb/s
Streaming Low 3 to 4.5 Mb/s	Streaming Low 13 to 20 Mb/s

H.265	
HD	4K
Streaming High 2.3 to 4.5 Mb/s	Streaming High 22.5 to 30 Mb/s
Streaming Medium 1.5 to 3 Mb/s	Streaming Medium 14 to 20 Mb/s
Streaming Low 0.8 to 2 Mb/s	Streaming Low 8 to 10 Mb/s

Le débit de données utilisé par le paramètre de qualité change selon la norme vidéo du Web Presenter. Par exemple, si vous sélectionnez une qualité de streaming élevée (Streaming high), et que vous opérez à 1080p24, le débit de données sera de 6 Mb/s.

Comme le montre le tableau, les débits de données du streaming sont plus basses que celles de l'HyperDeck. Cela permet de transmettre des données via Internet, ce qui utilise moins de bande passante que d'enregistrer des données sur un disque.

Vous remarquerez que chaque option comprend 2 débits. Le débit le plus bas est utilisé pour les fréquences d'images les plus basses de 24p, 25p et 30p. Le débit le plus élevé est utilisé pour les fréquences d'images les plus élevées de 50p et 60p. Veuillez noter que le débit pour le streaming est réglé par défaut sur Streaming High, car il offre une très haute qualité de streaming.

Boutons Off et On air

Vous pouvez lancer et arrêter le streaming live en utilisant les boutons **On air** et **Off**. Le bouton **On air** s'allume en rouge lorsque le streaming live est en cours.

Supprimer les paramètres importés

Pour supprimer tous les paramètres de streaming importés depuis votre Web Presenter, cliquez sur l'icône de la roue dentée en bas à gauche de l'onglet **Live stream**. Pour confirmer votre choix, cliquez sur **Remove**.

Onglet Audio

L'onglet Audio contient les options pour configurer la sortie de monitoring audio et les indicateurs audio de votre Web Presenter.

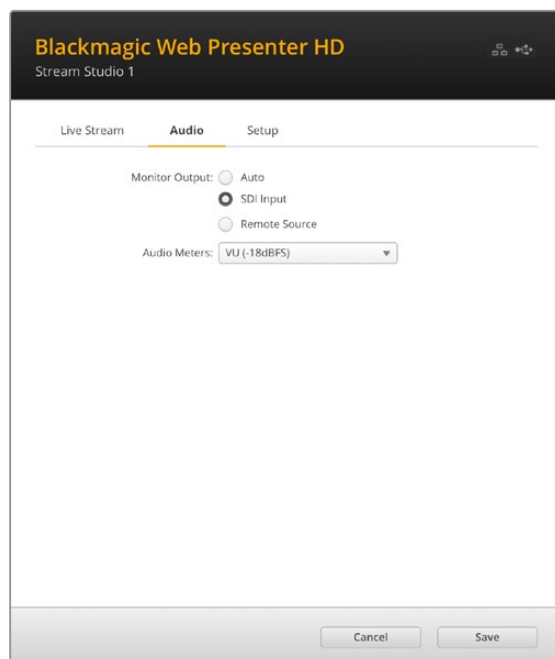

Monitor Output

Utilisez les options de la sortie de monitoring afin de choisir la source audio pour les sorties de monitoring SDI et HDMI de votre Web Presenter.

Auto

Quand la sortie de monitoring est réglée sur Auto, votre Web Presenter détectera et vérifiera automatiquement l'audio du réseau d'ordres envoyé depuis un mélangeur ATEM via un ATEM Streaming Bridge. Si aucun réseau d'ordres n'est détecté, l'audio provenant de l'entrée SDI sera utilisé.

SDI Input

Sélectionnez SDI input pour contrôler l'audio depuis la source d'entrée SDI de votre Web Presenter, comme une Blackmagic Studio Camera connectée.

Remote Source

Utilisez cette option pour vérifier l'audio du réseau d'ordres envoyé depuis un mélangeur ATEM à distance ou un ATEM Streaming Bridge.

Audio Meters

Utilisez ce menu pour sélectionner le type d'indicateur audio à afficher. Les options disponibles sont les niveaux de références VU -18dBFS, VU -20dBFS, PPM -18dBFS ou PPM -20dBFS.

Onglet Setup (réglages)

Blackmagic Web Presenter HD
Stream Studio 1

Live Stream Audio **Setup**

Name: Stream Studio 1
Language: English
Software: Version 3.3

Network

Protocol: DCHP Static IP
IP Address: 192.168.24.100
Subnet Mask: 255.255.255.0
Gateway: 192.168.24.1
Primary DNS: 8.8.8.8
Secondary DNS: 8.8.4.4
Connection Priority: Ethernet Mobile

Reset
Factory Reset

Cancel Save

Name

Si vous souhaitez renommer votre Web Presenter, saisissez un nouveau nom dans la boîte et cliquez sur **Save**.

Language

Permet de changer la langue de l'appareil.

Software

Affiche la version logicielle du Web Presenter.

Network (réseau)

Ces paramètres vous permettent de configurer les options réseau, comme le choix de connexion à un réseau via DHCP ou via une adresse statique IP. Pour plus d'informations sur la connexion de votre Web Presenter à un réseau, veuillez consulter la section « Connexion à un réseau ».

Connection Priority – Lorsqu'Ethernet et un téléphone portable sont tous les deux connectés au Web Presenter, ce paramètre permet de sélectionner quelle connexion est prioritaire pour le streaming. Pour plus d'informations sur le partage des données mobiles, veuillez consulter la section « Streamer à l'aide de votre smartphone ».

Reset (Réinitialiser)

Réinitialisez votre Web Presenter en cliquant sur le bouton **Factory reset**.

Network Settings (Paramètres du réseau)

Votre Web Presenter peut se connecter au réseau avec une adresse IP statique ou un DHCP.

DHCP – Réglera automatiquement une adresse IP pour votre appareil et le connectera à votre réseau sans changer les paramètres.

Le Dynamic Host Configuration Protocol, ou DHCP, est un service de serveurs et de routeurs réseau qui détecte automatiquement votre Web Presenter et lui attribue une adresse IP. Le DHCP facilite la connexion des équipements via Ethernet et veille à ce que leur adresse IP ne soit pas en conflit l'une avec l'autre. La plupart des ordinateurs et des commutateurs réseau supportent le DHCP.

Static IP – Pour régler l'adresse IP vous-même, configurez les paramètres du protocole sur Static IP afin de modifier les réglages IP manuellement.

Une adresse IP statique ne changera pas, même si vous redémarrez le Web Presenter.

Utiliser une adresse IP statique peut être nécessaire si vous connectez votre Web Presenter à un réseau d'entreprise. Si vous avez un administrateur réseau, il est possible que votre réseau ait des adresses IP personnalisées pour tous les équipements connectés. Il est conseillé de vérifier cela auprès de votre administrateur réseau s'il gère vos ordinateurs et le réseau dans votre entreprise.

Régler le partage de connexion Internet pour le streaming direct

Si vous ne pouvez pas brancher directement le Web Presenter à un commutateur réseau ou un routeur Internet, il est possible de partager la connexion Internet depuis votre ordinateur via le port Ethernet du Web Presenter.

Pour régler le Blackmagic Web Presenter pour le streaming direct via Ethernet :

- 1 Réglez votre Web Presenter pour qu'il utilise le DHCP.
- 2 Configurez votre ordinateur pour qu'il partage sa connexion Internet via son port Ethernet.
Mac : Dans Préférences Système, cliquez sur **Partage**, puis sélectionnez **Partage Internet** dans la liste **Service**. Dans le menu **Partager votre connexion depuis**, choisissez **Wi-Fi** si votre Mac est connecté à Internet via WiFi. Dans la liste **Aux ordinateurs via**, sélectionnez **Ethernet**. Dans la liste **Service**, cochez la case **Partage Internet**. Lorsque l'on vous demande si vous êtes sûr de vouloir activer le partage Internet, cliquez sur **Démarrer**.
Windows : Faites un clic droit sur l'icône **Démarrer**, puis sélectionnez **Connexions réseaux**. L'état du réseau s'affiche. Cliquez sur **Modifier les options d'adaptateur** pour afficher une liste des connexions réseau de votre ordinateur. Faites un clic droit sur la connexion Internet et sélectionnez **Propriétés**. Dans l'onglet **Partage**, cochez **Autoriser d'autres utilisateurs du réseau à se connecter via la connexion Internet de cet ordinateur**. Sélectionnez une connexion réseau dans le menu, puis cliquez sur **OK**.
- 3 Branchez le Web Presenter au port Ethernet de votre ordinateur. Après quelques secondes, le DHCP assigne une adresse IP au Web Presenter.
- 4 Vérifiez que le Web Presenter HD est connecté à Internet via Ethernet en regardant l'icône Ethernet en haut à droite de l'écran LCD de l'appareil.

Streamer à l'aide de votre smartphone

Le Blackmagic Web Presenter peut streamer depuis la connexion Internet de votre smartphone. Ainsi, vous pouvez streamer dans le monde entier d'où vous le voulez, du moment que votre smartphone capte une connexion Internet.

Pour régler le partage de connexion mobile :

- 1 Connectez votre smartphone au Blackmagic Web Presenter à l'aide d'un câble USB-C. Vous pouvez utiliser le connecteur USB-C à l'avant ou à l'arrière du panneau.
- 2 Activez le partage de connexion Internet sur votre smartphone.

Sur votre appareil iOS ouvrez Réglages > Partage de connexion et veillez à ce que l'option **Autoriser d'autres utilisateurs** soit activée. Sur votre appareil Android, balayez l'écran pour afficher le menu. Appuyez longuement sur l'icône de point d'accès, puis activez le partage de connexion via USB.

Maintenant, vous pouvez appuyer sur le bouton **On air** de votre Blackmagic Web Presenter pour lancer le direct.

CONSEIL Une fois le streaming terminé, nous vous recommandons de désactiver le partage de connexion afin d'économiser la batterie de votre smartphone.

Si un câble Ethernet est connecté à votre Web Presenter, vérifiez qu'il est configuré pour utiliser le partage de connexion Internet depuis votre téléphone. Ouvrez l'utilitaire Web Presenter Setup et allez sur l'onglet **Setup**. Dans la section **Network**, réglez la priorité de connexion (connection priority) sur **Mobile**.

Utiliser le Blackmagic Web Presenter comme une webcam

Les logiciels comme Skype ou Zoom règlent généralement le Web Presenter en tant que webcam automatiquement. Ainsi, quand vous lancez l'application, la vidéo de votre Web Presenter apparaît automatiquement. Si l'application ne sélectionne pas le Web Presenter automatiquement, réglez-la manuellement pour qu'elle utilise le Web Presenter en tant que webcam et microphone.

Vous trouverez ci-dessous un exemple pour régler les paramètres de la webcam sur Skype.

- 1 Dans la barre de menu de Skype, ouvrez les paramètres **Audio et Vidéo**.
- 2 Dans le menu **Caméra**, sélectionnez votre Web Presenter dans la liste. La vidéo du Web Presenter apparaîtra dans la fenêtre de prévisualisation.
- 3 Allez dans le menu **Micro** et sélectionnez le Web Presenter en tant que source audio.

Configurer Open Broadcaster

Open Broadcaster est une application open source qui fait office de plateforme de streaming entre votre Web Presenter et votre logiciel de streaming favori, tel que YouTube, Twitch ou encore Facebook. Open Broadcaster compresse la vidéo en un débit binaire facilement gérable par votre application de streaming.

Ci-dessous, vous trouverez les étapes pour configurer Open Broadcaster afin de diffuser la sortie webcam de votre Web Presenter à l'aide du service de streaming YouTube Live.

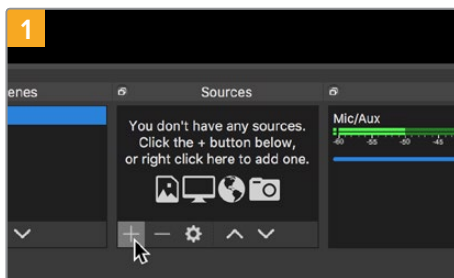

Ouvrez Open Broadcaster et cliquez sur le symbole + dans la boîte de dialogue Sources.

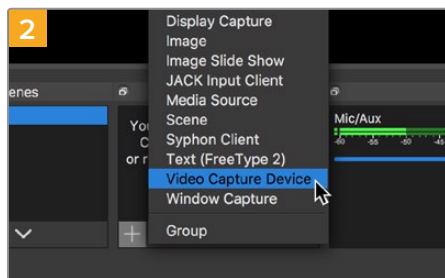

Sélectionnez Video Capture Device.

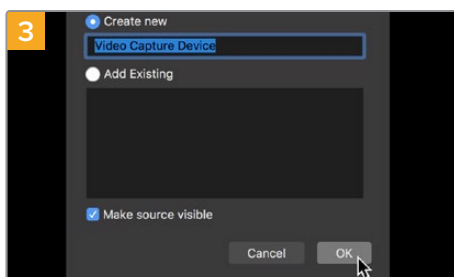

Nommez la nouvelle source et cliquez sur OK.

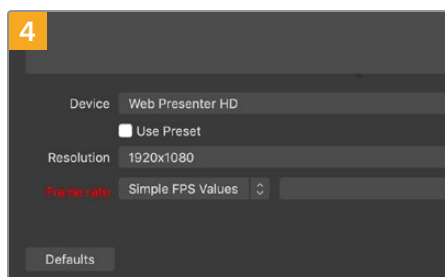

Dans le menu Device, sélectionnez le modèle de votre Web Presenter et cliquez sur OK.

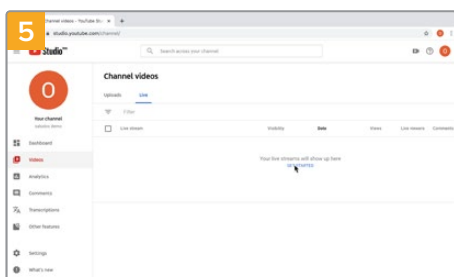

Allez sur votre compte YouTube. Cliquez sur le bouton Go live, puis sur Stream.

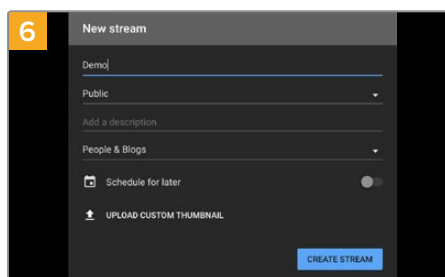

Dans les options de flux de YouTube, saisissez les informations de votre diffusion et cliquez sur Create stream.

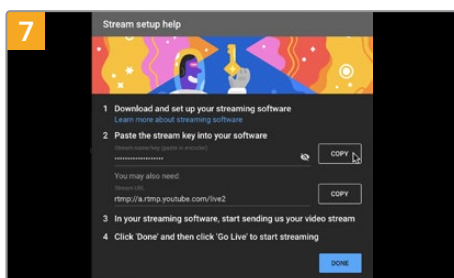

YouTube va générer une clé de stream qui va diriger Open Broadcaster vers votre compte YouTube. Cliquez sur le bouton Copy à côté de la clé de stream. Copiez la clé de stream pour la coller dans Open Broadcaster.

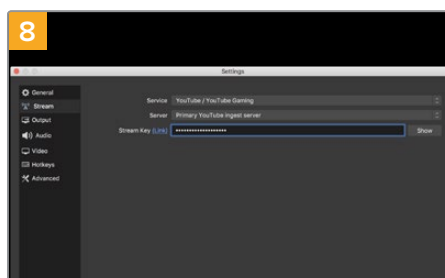

Retournez sur Open Broadcaster et ouvrez les préférences en cliquant sur OBS/préférences dans la barre de menu. Sélectionnez Stream. Collez la clé de stream que vous avez copiée de YouTube et cliquez sur OK.

La vidéo du Web Presenter apparaît dans la fenêtre de prévisualisation du streaming d'Open Broadcaster.

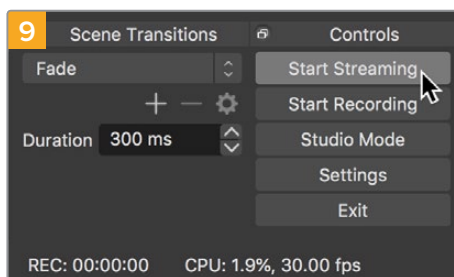

Pour connecter le lien de diffusion d'Open Broadcaster à YouTube, cliquez sur **Start Streaming** en bas à droite de l'écran. Cela établit un lien d'Open Broadcaster à YouTube. À partir de là, tout sera réglé avec YouTube Live.

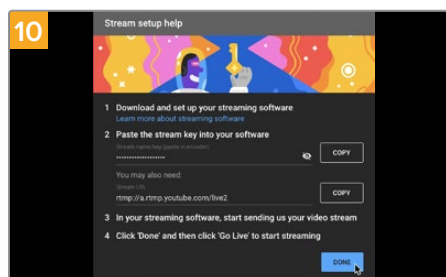

Retournez sur YouTube Live. Vous verrez la sortie programme webcam depuis votre Web Presenter en arrière-plan. Cliquez sur **Done**.

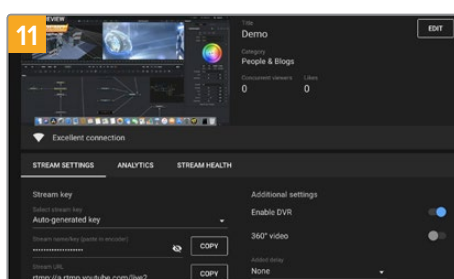

Maintenant qu'Open Broadcaster communique avec YouTube Live, vous pouvez commencer votre diffusion. Il est temps de faire les dernières vérifications afin de vous assurer que tout fonctionne.

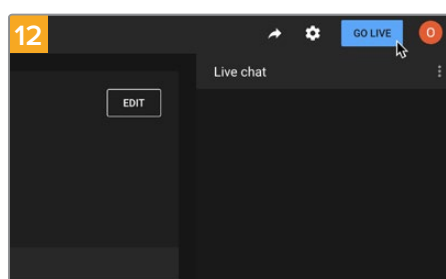

Lorsque vous êtes prêt, vous pouvez commencer la diffusion en cliquant sur **Go live**.

Vous diffusez maintenant du contenu en direct sur YouTube avec Open Broadcaster.

REMARQUE En raison de la nature du streaming sur Internet, il se peut qu'il y ait un retard, c'est pourquoi il est important de regarder la diffusion sur YouTube pour confirmer que votre programme est terminé avant de cliquer sur **End stream**. Vous éviterez ainsi de couper accidentellement la fin du programme.

Créer des liens vidéo avec l'ATEM Streaming Bridge

L'ATEM Streaming Bridge permet de décoder un stream vidéo depuis n'importe quel Web Presenter et de le reconvertir en vidéo SDI et HDMI. Ainsi, vous pouvez envoyer de la vidéo à travers votre réseau local ou partout dans le monde via Internet.

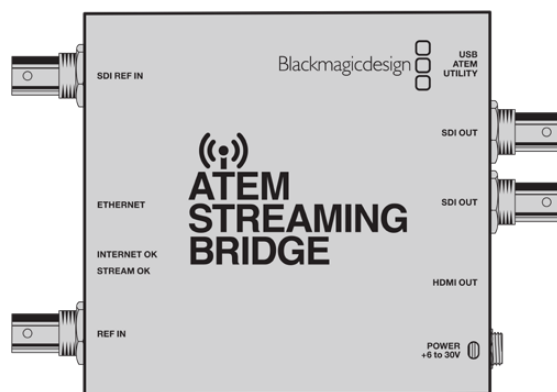

Si votre ATEM Streaming Bridge est connecté au même réseau local que votre Web Presenter, il sera listé dans le menu **Platform** de l'onglet **Live stream** du Web Presenter Setup.

Sinon, vous pouvez charger un fichier XML de paramétrage du streaming depuis un disque USB connecté au Web Presenter ou via le Web Presenter Setup installé sur votre ordinateur.

Transmettre un bulletin météo au studio depuis le lieu de tournage est un bon exemple de la façon dont le Blackmagic Web Presenter fonctionne avec l'ATEM Streaming Bridge. Tout ce dont vous avez besoin pour une transmission à distance est d'un Web Presenter et d'une connexion Internet qui peut provenir d'un smartphone ou d'une connexion réseau.

Au studio, l'ATEM Streaming Bridge convertit le flux Internet en SDI afin qu'il puisse être connecté au mélangeur principal du studio.

Voici la configuration du workflow pour cet exemple :

- 1 Sur le lieu de tournage, le Blackmagic Web Presenter est connecté à la sortie programme SDI du mélangeur, par exemple l'ATEM Constellation 8K.
- 2 Le Blackmagic Web Presenter est connecté à un smartphone.
- 3 Au studio, l'ATEM Streaming Bridge est également connecté à Internet via Ethernet.
- 4 L'ATEM Streaming Bridge envoie le flux vidéo SDI converti d'Internet vers l'entrée SDI du mélangeur situé dans le studio pour la diffusion.

Pour que votre studio connecte l'ATEM Streaming Bridge au flux Internet du Web Presenter, il vous faudra ouvrir l'utilitaire ATEM Setup et configurer les paramètres Internet. Il sera également nécessaire de générer un fichier XML contenant tous les paramètres du streaming qui seront chargés dans le Web Presenter sur site.

Créer le fichier XML

Pour créer un fichier de paramètres XML, connectez l'ATEM Streaming Bridge à Internet en branchant un câble réseau du port Ethernet au routeur Internet ou au commutateur réseau.

Connectez l'ATEM Streaming Bridge à votre ordinateur à l'aide d'un câble USB-C et lancez l'ATEM Setup.

Dans l'onglet Setup, vérifiez que les paramètres réseau sont corrects et sélectionnez **Internet** dans les options **Stream service**. Le message **Visible worldwide** devrait s'afficher dans la boîte d'état d'Internet. Cela veut dire que tout fonctionne correctement.

Remarque sur la redirection de port

Si une erreur de redirection de port ou UPnP s'affiche dans la boîte d'état d'Internet, il faudra demander à votre fournisseur de services Internet ou à votre administrateur réseau de configurer la redirection de port de votre connexion Internet sur **TCP port 1935**.

Exporter le fichier XML

Une fois que vous avez confirmé vos paramètres dans l'onglet de l'ATEM Setup et que vous avez réussi à connecter l'ATEM Streaming Bridge à votre réseau ou à Internet, vous pouvez exporter le fichier XML.

- 1 Cliquez sur l'onglet **External ATEM Mini Pro** en haut à droite de la fenêtre.

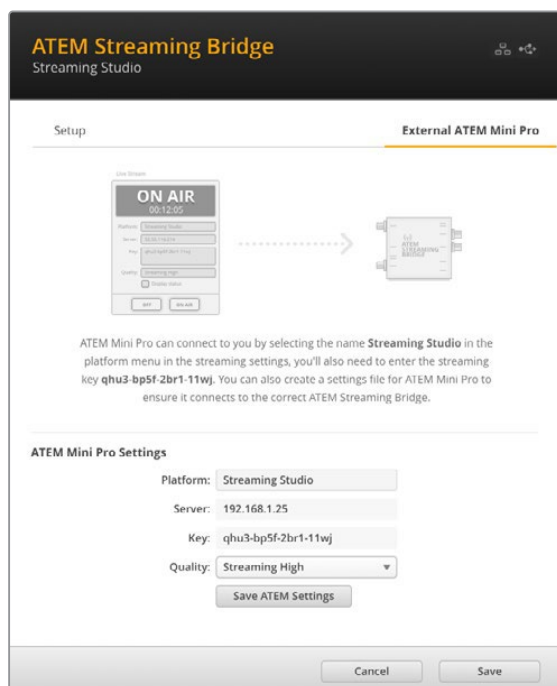

- 2 Pour personnaliser le nom de la plateforme, cliquez dans la boîte **Platform** et saisissez le nom souhaité. Ce nom sera affiché dans le menu plateforme de l'appareil Blackmagic connecté à distance.
- 3 Sélectionnez la qualité du streaming. Ce paramètre réglera la qualité du Web Presenter connecté à distance.
- 4 Cliquez sur le bouton **Save ATEM Settings**, choisissez un emplacement sur votre ordinateur pour sauvegarder le fichier XML et cliquez sur **Save**.
- 5 Vous pouvez maintenant envoyer par email le fichier XML sauvegardé à l'opérateur à distance.

CONSEIL Vous pouvez utiliser les paramètres de réseau d'ordres de l'ATEM Setup pour sélectionner les canaux audio que vous souhaitez renvoyer au Web Presenter à distance.

Charger le fichier XML

Une fois le fichier de paramètres envoyé sur le lieu de tournage, l'équipe pourra le charger dans le Web Presenter à l'aide du Web Presenter Setup, puis appuyer sur On air pour démarrer le streaming du bulletin météo au studio.

Il est important de mentionner qu'une fois que vous aurez chargé le fichier de streaming XML, vous pourrez démarrer et arrêter le streaming sans avoir à le recharger. Ainsi, il sera facile de configurer un lien vidéo constant entre le Web Presenter et l'ATEM Streaming Bridge.

Tant que l'ATEM Streaming Bridge au studio n'a pas changé de paramètres de streaming et de réseau, et qu'il cherche toujours le Web Presenter, il le trouvera peu importe son emplacement sur Internet. Il vous suffira de brancher votre Web Presenter à Internet et d'appuyer sur **On air** pour streamer immédiatement vers l'ATEM Streaming Bridge au studio.

Pour plus d'informations sur la façon d'utiliser l'ATEM Streaming Bridge, consultez le manuel ATEM Mini qui peut être téléchargé sur www.blackmagicdesign.com/fr/support

Tally, réseau d'ordres et contrôle caméra

L'ATEM Streaming Bridge et le Blackmagic Web Presenter permettent également aux mélangeurs ATEM d'envoyer les informations concernant le tally, le réseau d'ordres et le contrôle caméra. Ainsi, toute caméra SDI Blackmagic Design se trouvant sur votre réseau local ou n'importe où dans le monde via Internet, peut disposer du tally, du réseau d'ordres et du contrôle caméra.

C'est très simple à configurer. L'illustration ci-dessous indique comment connecter une URSA Mini Pro 4.6K à un ATEM Constellation 8K sur un réseau local et disposer du tally, du réseau d'ordres et du contrôle caméra.

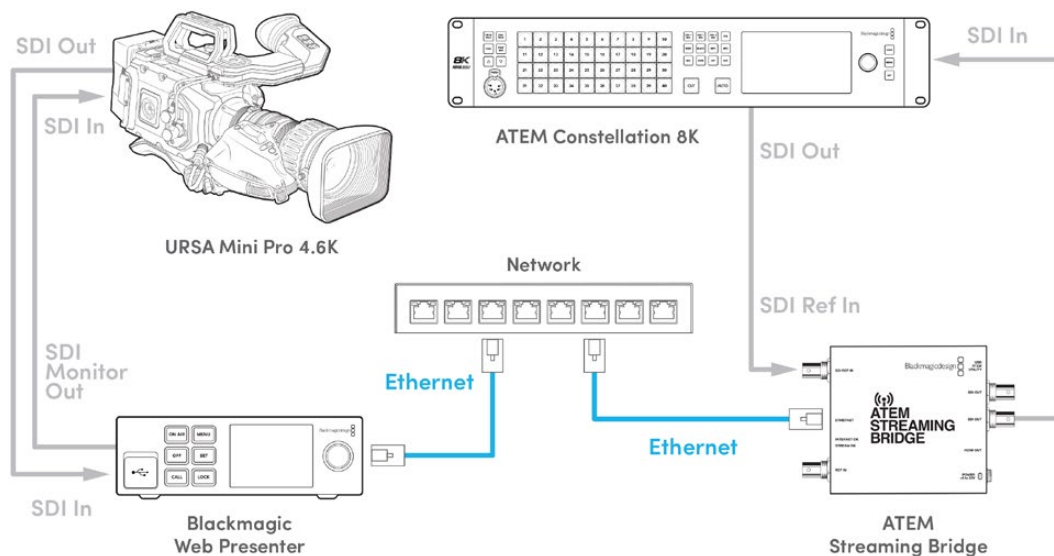

Quand tout est connecté :

- 1 Appuyez sur le bouton **Menu** du Blackmagic Web Presenter pour ouvrir le menu à l'écran et allez sur le menu **Stream en direct**.
- 2 Sélectionnez l'ATEM Streaming Bridge dans le menu **Plateforme**.
- 3 Appuyez sur Set pour confirmer votre choix.

Pour que le tally fonctionne, veillez à ce que l'identifiant de la caméra pour l'ATEM corresponde à l'entrée sur le mélangeur. Pour plus d'informations sur la façon de régler cet identifiant, consultez le manuel de la URSA Mini.

Pour vérifier que le tally fonctionne, faites basculer la caméra sur la sortie programme du mélangeur ATEM. Si l'identifiant de la caméra pour l'ATEM est réglé correctement sur votre caméra, le voyant tally ainsi qu'une bordure rouge autour de l'écran LCD de la caméra s'allumeront. Maintenant, commutez la caméra sur la sortie prévisualisation, et le voyant tally deviendra vert.

Essayez d'ajuster l'iris et le niveau de noir sur la page Caméra de l'ATEM Software Control pour tester le contrôle caméra.

Par défaut, les canaux du réseau d'ordres sont les canaux audio 15 et 16 intégrés au signal SDI. Toutefois, vous pouvez les régler sur les canaux ingénieurs 13 et 14, ou sur la sortie programme à l'aide de l'utilitaire ATEM Setup.

Lors de la transmission via Internet, un fichier de configuration XML est créé à l'aide de l'utilitaire ATEM Setup. Ce fichier XML est ensuite chargé dans le Blackmagic Web Presenter afin que ce dernier puisse trouver l'ATEM Streaming Bridge sur Internet. Pour plus d'informations sur la façon de créer et de charger le fichier de configuration XML, consultez la section précédente de ce manuel.

Connecter la URSA Broadcast G2

Comme la URSA Broadcast G2 intègre un moteur de streaming, il n'est pas nécessaire d'utiliser de Blackmagic Web Presenter, car la caméra peut streamer directement à partir de son port expansion USB-C. Pour plus d'informations, par exemple pour régler l'identifiant ATEM de la caméra afin que le tally fonctionne correctement, consultez le manuel de la URSA Broadcast G2.

Blackmagic Universal Rack Shelf

Le Blackmagic Universal Rack Shelf est un support d'une unité de rack qui vous permet d'installer une large gamme d'équipements Blackmagic Design dans un rack broadcast ou une caisse de transport. Grâce à son design modulaire, vous pouvez créer des configurations de matériel portables et pratiques avec des produits au format d'une unité de rack.

L'illustration ci-dessous montre 3 Universal Rack Shelf installés dans un petit rack avec une combinaison d'appareils compatibles. La partie inférieure comprend une plaque d'obturation d'une largeur d'un tiers de rack pour remplir l'espace vide entre les appareils.

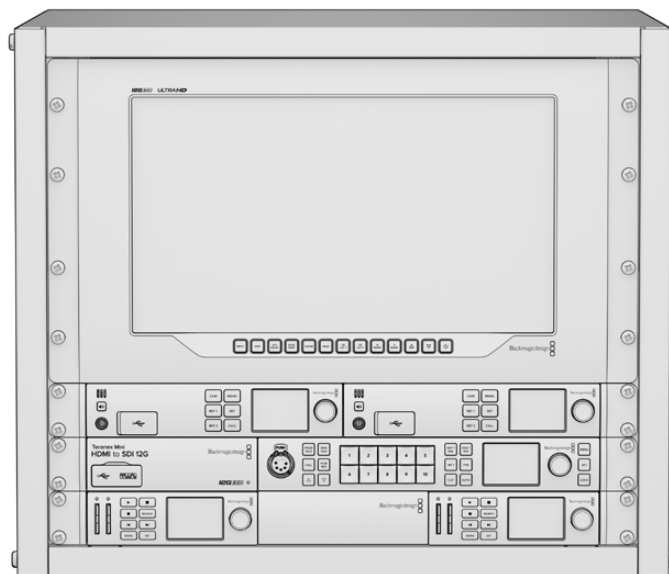

Contenu

L'Universal Rack Shelf Kit contient les éléments suivants :



1 x Blackmagic Universal Rack Shelf

Support d'une unité de rack pour installer des équipements Blackmagic Design.

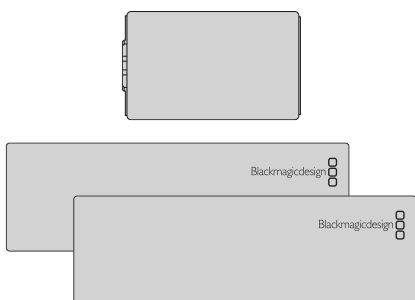

Plaques d'obturation

1 x plaque d'obturation de 1/6 de rack et 2 x plaques d'obturation de 1/3 de rack pour couvrir les espaces vides.

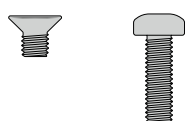

Vis

12 x vis de montage à tête fraisée M3 5mm.

2 x vis à tête plate M3 9mm pour les plaques d'obturation de 1/6.

Installer un appareil sur l'Universal Rack Shelf

- 1 Si les pieds en caoutchouc sont installés, retirez-les de la base de l'appareil à l'aide d'un gratteur en plastique.
- 2 Une fois l'Universal Rack Shelf et l'appareil retournés, alignez les trous pré-perçés de l'Universal Rack Shelf avec les trous de montage filetés de la base de l'appareil Blackmagic Design. Il y a deux pas de vis centraux sur les appareils d'une largeur d'un tiers de rack et jusqu'à trois pas de vis sur les appareils plus larges d'un demi-rack.

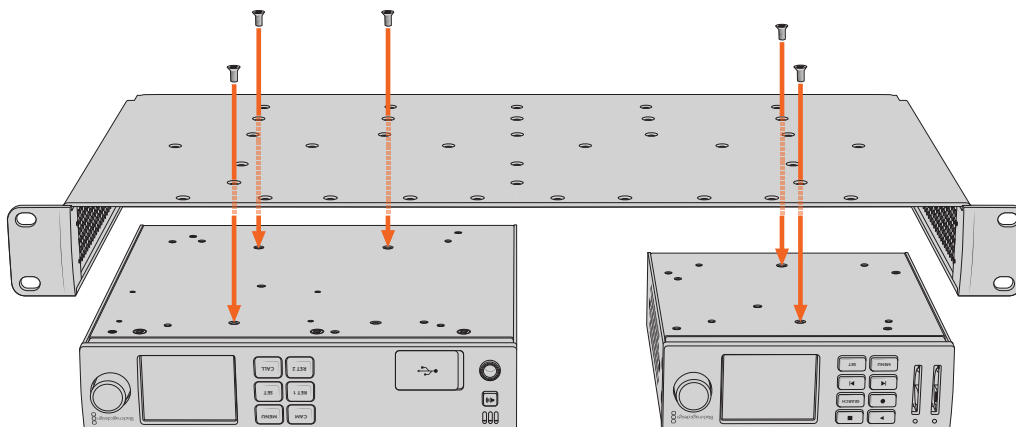

- 3 À l'aide des vis M3 5mm à tête fraisée, vissez l'appareil sur l'Universal Rack Shelf.
- 4 Une fois l'appareil fixé, retournez l'Universal Rack Shelf et installez-le dans le rack via les supports latéraux intégrés.

Les plaques d'obturation fournies peuvent être utilisées pour couvrir les espaces vides.

Fixer une plaque d'obturation de 1/6

La petite plaque d'obturation de 1/6 de rack peut être utilisée pour remplir les espaces vides lorsque vous installez des appareils d'une largeur de 1/2 et de 1/3 de rack. Cette plaque peut se fixer sur les côtés de chaque appareil. Il est conseillé d'installer la plaque entre les appareils pour améliorer la circulation de l'air.

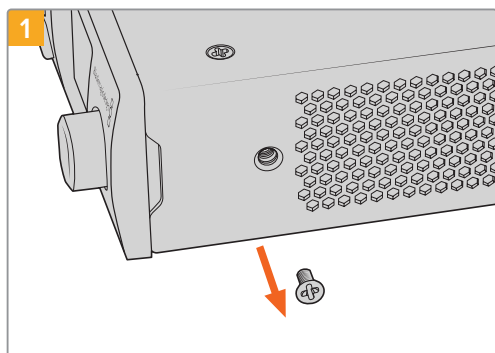

Retirez la vis M3 5mm située près de la face avant de l'appareil

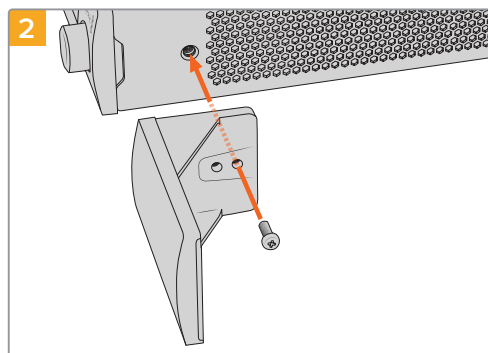

Alignez la plaque d'obturation et fixez-la à l'aide de la vis M3 9mm en nylon

Fixer la plaque d'obturation latérale de 1/3 de largeur

Les plaques d'obturation de 1/3 de largeur peuvent être fixées directement sur les deux côtés de l'Universal Rack Shelf lorsque vous installez un seul appareil. Pour installer une plaque d'obturation, alignez les trous de vis et le point d'ancrage à la base de la plaque avec l'Universal Rack Shelf et fixez-la à l'aide de deux des vis à tête fraisée M3 5mm fournies.

Mise à jour du logiciel interne

L'utilitaire Web Presenter Setup vous permet de mettre à jour le logiciel interne de votre Web Presenter, mais également de configurer les paramètres de streaming, les paramètres réseau et la qualité du streaming.

Mettre à jour le logiciel interne :

- 1 Téléchargez le nouveau programme d'installation du Blackmagic Web Presenter sur www.blackmagicdesign.com/fr/support.
- 2 Lancez le programme d'installation du Blackmagic Web Presenter et suivez les instructions à l'écran.
- 3 Une fois l'installation terminée, connectez le Web Presenter à votre ordinateur via le port USB du panneau arrière ou le port du panneau avant situé sous la protection en plastique.
- 4 Lancez le Blackmagic Web Presenter Setup et suivez les instructions affichées à l'écran pour mettre à jour le logiciel interne. Si aucune mise à jour n'apparaît, cela signifie que le logiciel interne est à jour.

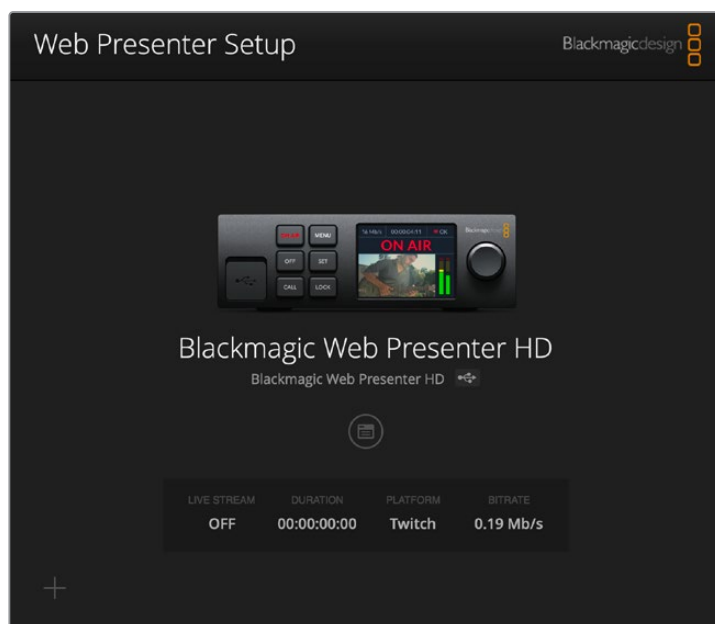

Téléchargez la dernière version de l'utilitaire pour le Blackmagic Web Presenter à partir de la page d'assistance Blackmagic sur www.blackmagicdesign.com/fr/support.

Developer Information

Blackmagic Web Presenter Ethernet Protocol

v1.2

Protocol Details

Overview

The Blackmagic Web Presenter Ethernet Protocol is a line-oriented, text-based protocol to control a Web Presenter.

Lines from the Web Presenter server will be separated by an ASCII LF sequence.

Messages from the user may be separated by LF or CR LF.

Connection

The Web Presenter server is accessed by connecting to TCP port 9977 on a Web Presenter.

Connection Response

Upon connection, the Web Presenter server sends a dump of the device's state.

The Web Presenter server sends information in blocks, with each having an identifying header followed by a colon. A block spans multiple lines and is terminated by a blank line. Each line in the protocol is terminated by a newline character.

Following the header, a block contains either a single multi-line string or a sequence of key/value pairs arranged one per line. The first full-colon on a line is used to delimit the key and the value. A value may be a comma separated list. In this case, values in the list must have the “,” and “\” characters escaped with a “\” character.

To be resilient to future protocol changes, clients should ignore blocks they do not recognize, up to the trailing blank line. Within recognized blocks, clients should ignore keys they do not recognize.

Legend	
↵	End of line
...	and so on
Orange Text	Client Generated
Grey Text	Server Generated

The protocol preamble block is always the first block sent by the Web Presenter server:

```
PROTOCOL PREAMBLE:↵
Version: 1.2↵
↵
```

The version field indicates the protocol version. When the protocol is changed in a compatible way, the minor version number will be updated. If incompatible changes are made, the major version number will be updated.

The initial status dump is concluded by the end prelude block:

```
END PRELUDE:↵
↵
```

Status Updates

When any device parameter is changed on the Web Presenter server by any client, such as the Blackmagic Web Presenter Setup utility, the Web Presenter server resends the applicable status block, containing only the items that have changed. Status updates can also occur due to external changes such as tethering to a smartphone or when a streaming service is disconnected.

For example, if the input video mode is set to Auto, the following block will be sent:

```
STREAM SETTINGS:↵  
Video Mode: Auto↵  
↵
```

Requesting Changes

To change one or more parameters in a block, the client should send the appropriate block header in the same form the Web Presenter server sends, followed by the key/value pairs to be changed. For example, to change the input video format to 1080p59.94, the user should send the following block:

```
STREAM SETTINGS:↵  
Video Mode: 1080p59.94↵  
↵
```

The block must be terminated by a blank line. On receipt of a blank line, the Web Presenter server will either acknowledge the request by responding:

```
ACK↵  
↵
```

or if unable to parse the block responding with:

```
NACK↵  
↵
```

After a positive response, the client should expect to see a status update from the Web Presenter server showing the status change. This is likely to be the same as the command that was sent, sometimes followed by other blocks providing data specific to the change.

```
STREAM SETTINGS:↵  
Video Mode: 1080p59.94↵  
↵
```

If the Web Presenter server does not understand a key in the requested block, the key will be ignored. If an invalid value is provided for a known key, then the request is ignored and the Web Presenter will respond with the existing value for the key. In both cases the Web Presenter server will still respond with an ACK.

```
STREAM SETTINGS:↵  
Video Mode: UnsupportedMode↵  
↵  
ACK↵  
↵  
STREAM SETTINGS:↵  
Video Mode: 1080p59.94↵  
↵
```

Requesting a Status Dump

The user may request that the Web Presenter server resend the complete state of any status block by sending the block header, followed by a blank line. In the following example, the user requests the Web Presenter server resend the stream settings:

```
STREAM SETTINGS:↵
↵
ACK↵
↵
STREAM SETTINGS:↵
Video Mode: 1080p59.94↵
...
↵
```

Protocol Blocks

Identity Block

The identity block contains information to identify the connected Web Presenter.

Block Syntax

The following example shows the Identity Block for a Blackmagic Web Presenter HD.

```
IDENTITY:↵
Model: Blackmagic Web Presenter HD↵
Label: Blackmagic Web Presenter HD↵
Unique ID: 00112233445566778899AABBCCDDEEFF↵
↵
```

Parameters

Key	Read/Write	Description	Valid Values
Model	Read only	The Web Presenter model name	String
Label	Read/Write	A display name for the Web Presenter	String
Unique ID	Read only	A device specific unique identifier	Hexadecimal ID

Changing Device Label

A device label to identify the Web Presenter can be changed by sending an identity block with label key.

```
IDENTITY:↵
Label: My Web Presenter↵
↵
ACK↵
↵
IDENTITY:↵
Label: My Web Presenter↵
↵
```

Version Block

The version block contains hardware and software version information for the connected Web Presenter.

Block Syntax

```
VERSION:↵  
Product ID: BE73↵  
Hardware Version: 0100↵  
Software Version: 0123ABCD↵  
Software Release: 3.3↵  
↵
```

Parameters

Key	Read/Write	Description	Valid Values
Product ID	Read only	The Web Presenter product ID	Hexadecimal ID
Hardware Version	Read only	The Web Presenter hardware version	Hexadecimal version
Software Version	Read only	The Web Presenter software version	Hexadecimal version
Software Release	Read only	The Web Presenter software release version	Version Number

Network Blocks

The network block contains the TCP/IP networking configuration for the connected Web Presenter.

Block Syntax

This example shows the output for a connected Web Presenter. It displays 2 networking interfaces - the Gigabit Ethernet interface and option for a tethered smartphone.

The network settings prefixed with Current show the active TCP/IP settings, and are read-only. The Current settings reflect either the DHCP or Static configuration, depending on the Dynamic IP flag.

```
NETWORK:↵  
Interface Count: 2↵  
Default Interface: 0↵  
↵  
NETWORK INTERFACE 0:↵  
Name: Ethernet↵  
Priority: 1↵  
MAC Address: 00:11:22:33:44:55↵  
Dynamic IP: true↵  
Current Addresses: 192.168.1.10/255.255.255.0↵  
Current Gateway: 192.168.1.1↵  
Current DNS Servers: 192.168.1.1, 8.8.8.8, 8.8.4.4↵  
Static Addresses: 10.0.0.2/255.255.255.0↵  
Static Gateway: 10.0.0.1↵  
Static DNS Servers: 8.8.8.8, 8.8.4.4↵  
↵
```

```

NETWORK INTERFACE 1:↵
Name: USBEthernet↵
Priority: 0↵
MAC Address: 00:00:00:00:00:00↵
Dynamic IP: true↵
Current Addresses: 0.0.0.0/255.255.0.0↵
Current Gateway: 0.0.0.0↵
Current DNS Servers: ↵
Static Addresses: 10.0.0.2/255.255.255.0↵
Static Gateway: 10.0.0.1↵
Static DNS Servers: 8.8.8.8, 8.8.4.4↵
↵

```

Parameters

Network Block

Key	Read/Write	Description	Valid Values
Interface Count	Read only	The number of networking interfaces supported by the Web Presenter	Integer
Default Interface	Read only	The default networking interface	Integer

Network Interface Block

Key	Read/Write	Description	Valid Values
Name	Read only	The name of the networking interface	String
Priority	Read/Write	The priority of the network interface. When multiple network interfaces are available, the high priority interface will become the default	Unsigned integer. The higher number is the higher priority
MAC Address	Read Only	MAC address of the networking interface	IEEE 802 MAC address
Dynamic IP	Read/Write	Selects DHCP or Static IP configuration	true - DHCP enabled false - Static IP
Current Addresses	Read Only	The current IP address and Subnet mask	{IPv4 address}/{Subnet Mask}
Current Gateway	Read Only	The current IP gateway address	IPv4 address
Current DNS Servers	Read only	The IP addresses of the current DNS servers	Comma separated list of IPv4 addresses
Static Addresses	Read/Write	Status IP address and subnet mask when DHCP disabled	{IPv4 address}/{Subnet Mask}
Static Gateway	Read/Write	Static gateway address when DHCP disabled	IPv4 address
Static DNS Servers	Read/Write	The IP addresses of the static DNS servers	Comma separated list of IPv4 addresses

Changing Networking Settings

The network can be configured to use either DHCP or a static configuration. To enable DHCP on Network Interface 0:

```
NETWORK INTERFACE 0:↵
```

```
Dynamic IP: true↵
```

```
↵
```

```
ACK↵
```

```
↵
```

```
NETWORK INTERFACE 0:↵
```

```
Dynamic IP: true↵
```

```
↵
```

To set a fixed IP address, supply all static parameters:

```
NETWORK INTERFACE 0:↵
```

```
Dynamic IP: false↵
```

```
Static Addresses: 192.168.1.2/255.255.255.0↵
```

```
Static Gateway: 192.168.1.1↵
```

```
Static DNS Servers: 8.8.8.8, 8.8.4.4↵
```

```
↵
```

```
ACK↵
```

```
↵
```

```
NETWORK INTERFACE 0:↵
```

```
Dynamic IP: false↵
```

```
Static Addresses: 192.168.1.2/255.255.255.0↵
```

```
Static Gateway: 192.168.1.1↵
```

```
Static DNS Servers: 8.8.8.8, 8.8.4.4↵
```

```
↵
```

Changing network settings may cause the IP connection to be dropped.

UI Settings Block

The UI settings block contains the front panel LCD and monitor output settings for the connected Web Presenter.

Block Syntax

```
UI SETTINGS:↵
```

```
Available Locales: en_US.UTF-8, zh_CN.UTF-8, ja_JP.UTF-8, ko_KR.UTF-8, es_
ES.UTF-8, de_DE.UTF-8, fr_FR.UTF-8, ru_RU.UTF-8, it_IT.UTF-8, pt_BR.UTF-8,
tr_TR.UTF-8, pl_PL.UTF-8, uk_UA.UTF-8↵
```

```
Current Locale: en_US.UTF-8↵
```

```
Available Audio Meters: PPM -18dB, PPM -20dB, VU -18dB, VU -20dB↵
```

```
Current Audio Meter: PPM -20dB↵
```

```
↵
```

Parameters

Key	Read/Write	Description	Valid Values
Available Locales	Read only	The locales available in the Web Presenter	Comma separated list of locales
Current Locale	Read/Write	The current locale for Web Presenter	Refer to the locales from the Available Locales field
Available Audio Meters	Read only	The available audio meters supported by the Web Presenter	Comma separated list of audio meter types
Current Audio Meter	Read/Write	The current audio meter	Refer to the audio meters from the Available Audio Meters field

Stream Settings Block

The stream settings block contains the stream configuration for the connected Web Presenter.

Block syntax

This example shows the output for a connected Web Presenter. The stream settings prefixed with Current show the active stream settings and are writable. The stream settings prefixed by Available show the available stream settings for the device or platform and are read-only. To view the available servers or quality levels for a stream service, the Current Platform stream setting should be set first.

```
STREAM SETTINGS:↵
Available Video Modes: Auto, 1080p23.98, 1080p24, 1080p25, 1080p29.97,
1080p30, 1080p50, 1080p59.94, 1080p60, 720p25, 720p30, 720p50, 720p60↵
Video Mode: 1080p59.94↵
Current Platform: YouTube↵
Current Server: Primary↵
Current Quality Level: Streaming Medium↵
Stream Key: abc1-def2-ghi3-jkl4-mno5↵
Password: ↵
Current URL: srt://192.168.8.51
Customizable URL: true
Available Default Platforms: YouTube RTMP, YouTube SRT (Beta), Facebook,
Twitch, Twitter, Restream.IO, Vimeo, BoxCast, CastR, AfreecaTV, Bilibili,
DouYu, Weibo↵
Available Custom Platforms: My Platform↵
Available Servers: Primary, Secondary↵
Available Quality Levels: HyperDeck High, HyperDeck Medium, HyperDeck Low,
Streaming High, Streaming Medium, Streaming Low↵
↵
```

Parameters

Key	Read/Write	Description	Valid Values
Available Video Modes	Read only	The video modes available in the Web Presenter	Comma separated list of video modes
Video Mode	Read/Write	The current video mode	Refer to the video modes from the <i>Available Video Modes</i> field
Current Platform	Read/Write	The selected streaming platform	Refer to the platforms from the <i>Available Default Platforms</i> and <i>Available Custom Platforms</i> fields
Current Server	Read/Write	The current server for the streaming platform	Server is dependent on selected Current Platform
Current Quality Level	Read/Write	The current streaming quality level	Quality level is dependent on selected Current Platform
Stream Key	Read/Write	The stream key for the streaming platform	String
Password	Read/Write	The passphrase for an encrypted SRT stream	String
Current URL	Read/Write	The current URL for the streaming platform. This field is writable if <i>Customizable URL</i> field is true.	String
Customizable URL	Read only	A boolean specifying whether custom URLs are supported by the streaming platform	true - Custom URLs are supported false - Custom URLs are not supported
Available Default Platforms	Read only	The available default streaming platforms	Comma separated list of default platforms
Available Custom Platforms	Read only	The custom streaming platforms loaded in the Web Presenter	Comma separated list of custom platforms
Available Servers	Read only	The available servers for the selected streaming platform	Comma separated list of servers
Available Quality Levels	Read only	The available quality levels for the selected streaming platform	Comma separated list of quality levels

Changing Stream Settings

The stream settings can be changed by providing a stream settings block. The following is an example of streaming a 1080p59.94 input on Twitch with a medium stream quality.

```

STREAM SETTINGS:↵
Video Mode: 1080p59.94↵
Current Platform: Twitch↵
Current Server: US West: Los Angeles, CA↵
Current Quality Level: Streaming Medium↵
Stream Key: live_123456789_1aB2cD3eF4gH5iJ6kL7mN8oP9qR0sT↵
↵
ACK↵
↵
STREAM SETTINGS:↵
Video Mode: 1080p59.94↵
Current Platform: Twitch↵
Current Server: US West: Los Angeles, CA↵
Current Quality Level: Streaming Medium↵
Stream Key: live_123456789_1aB2cD3eF4gH5iJ6kL7mN8oP9qR0sT↵
↵

```

Stream XML Block

The stream XML block allows users to configure the Web Presenter with a custom configuration file in XML format.

Block syntax

The following example shows an XML file - Custom.xml has been loaded to configure the stream settings in the Web Presenter.

```
STREAM XML:↵  
Files: Custom.xml↵  
↵
```

Parameters

Key	Read/Write	Description	Valid Values
Files	Read/Write	The XML files loaded in Web Presenter	Comma separated list of filenames
Action	Write only	The stream XML action	Remove Remove All

Adding a Stream XML file

An XML file can be loaded onto a Web Presenter by sending the stream xml command with a filename, then provide the contents of the XML file. After adding the XML file, the Available Custom Platforms field in the STREAM SETTINGS block will be updated with the new platforms, however the Current items will remain unchanged.

For the Stream XML block to be parsed correctly, any blank lines should be removed from the XML files.

Refer to the `Blackmagic Stream XML File Format` section in this manual for description of the Stream XML file format.

```
STREAM XML Custom.xml:↵  
<?xml version="1.0" encoding="UTF-8"?>↵  
<streaming>↵  
    <service>↵  
        <name>My Custom Platform</name>↵  
        ...  
    </service>↵  
</streaming>↵  
↵  
ACK↵  
↵  
STREAM XML Custom.xml:↵  
<?xml version="1.0" encoding="UTF-8"?>↵  
<streaming>↵  
    <service>↵  
        <name>My Custom Platform</name>↵  
        ...  
    </service>↵  
</streaming>↵  
↵
```

```
STREAM XML:↵
Files: Custom.xml↵
↵
STREAM SETTINGS:↵
Available Custom Platforms: My Custom Platform↵
↵
```

Removing a Stream XML file

An XML file can be removed from the Web Presenter by sending the stream xml command with the remove action.

```
STREAM XML:↵
Action: Remove↵
Files: Custom.xml↵
↵
ACK↵
↵
STREAM XML:↵
Files:↵
↵
STREAM SETTINGS:↵
Available Custom Platforms:↵
↵
```

Removing all Stream XML files

All XML files can be removed from the Web Presenter by sending the stream xml command with the remove all action. In the example, following the remove all action, the loaded stream XML files and available custom platforms are both displayed as empty.

```
STREAM XML:↵
Action: Remove All↵
↵
ACK↵
↵
STREAM XML:↵
Files: ↵
↵
STREAM SETTINGS:↵
Available Custom Platforms:↵
↵
```

Stream State Block

The stream state block provides the streaming status of the Web Presenter.

The Web Presenter server will send a stream state block update whenever there is a change to the Status field. Due to frequency of changes to Duration, Bitrate and Cache Used fields, these fields need to be polled by the client by requesting a Stream State block.

Block syntax

```
STREAM STATE:↵↵
Status: Idle↵↵
Bitrate: 161672↵↵
Duration: 00:00:00:00↵↵
Cache Used: 0↵↵
↵↵
```

Parameters

Key	Read/Write	Description	Valid Values
Status	Read only	The stream state of the Web Presenter, updated when the stream status changes	Idle Connecting Streaming Interrupted
Action	Write only	The Web Presenter stream state action.	Start Stop
Duration	Read only	The duration of the active stream	String in format of DD:HH:MM:SS
Bitrate	Read only	The bitrate of the active stream	Integer bits per second
Cache Used	Read only	The current usage of the streaming cache	Integer as a percentage

Starting Stream

The stream is started by providing a stream state block with start action.

```
STREAM STATE:↵↵
Action: Start↵↵
↵↵
ACK↵↵
↵↵
STREAM STATE:↵↵
Status: Connecting↵↵
↵↵
STREAM STATE:↵↵
Status: Streaming↵↵
↵↵
```

Stopping stream

The stream is stopped by providing a Stream State block with stop action.

```
STREAM STATE:↵↵
Action: Stop↵
↵
ACK↵
↵
STREAM STATE:↵↵
Status: Idle↵
↵
```

Audio Settings Block

The Audio Settings block contains the audio configuration for the connected Web Presenter.

Block syntax

This example shows the output for a connected Web Presenter. The stream settings prefixed with Current show the active audio settings and are writable. The stream settings prefixed by Available show the available audio settings for the device or platform and are read-only.

```
AUDIO SETTINGS:↵↵
Current Monitor Out Audio Source: Auto↵
Available Monitor Out Audio Sources: Auto, SDI In, Remote Source↵
↵
```

Parameters

Key	Read/Write	Description	Valid Values
Current Monitor Out Audio Source	Read/Write	The current audio source on the monitor output	Refer to the audio sources from the <i>Available Monitor Out Audio Sources</i> field
Available Monitor Out Audio Sources	Read only	The available audio sources that can be routed to the monitor output	Comma separated list of audio sources

Changing Audio Settings

The audio settings can be changed by providing an audio settings block. The following is an example of setting the monitor output audio source to remote.

```
AUDIO SETTINGS:↵↵
Current Monitor Out Audio Source: Remote Source↵
↵
ACK↵
↵
AUDIO SETTINGS:↵↵
Current Monitor Out Audio Source: Remote Source↵
↵
```

Shutdown Block

The Shutdown block provides power control of the Web Presenter. The Shutdown block is write-only and not presented in the preamble.

Parameters

Key	Read/Write	Description	Valid Values
Action	Write only	The Web Presenter shutdown action.	Reboot Factory Reset

Reboot

The Web Presenter can be rebooted by providing a Shutdown block with reboot action.

```
SHUTDOWN:↵
```

```
Action: Reboot↵
```

```
↵
```

```
ACK↵
```

```
↵
```

On reboot action, the Web Presenter server will be stopped and clients will be disconnected.

Factory Reset

The Web Presenter can be factory reset by providing a Shutdown block with factory reset action. On factory reset action, all settings are set to factory defaults.

```
SHUTDOWN:↵
```

```
Action: Factory Reset↵
```

```
↵
```

```
ACK↵
```

```
↵
```

Blackmagic Streaming XML Format

Overview

The Blackmagic Streaming XML allows users to specify streaming services in addition to the default services provided by the Web Presenter.

The Streaming XML can be loaded into the Web Presenter with Web Presenter Setup. Refer to the 'Using Web Presenter Setup' section earlier in this manual

The Streaming XML can also be loaded by copying the contents into the Stream XML block with the Blackmagic Web Presenter Ethernet Protocol.

The following is a minimal example of a Streaming XML file:

```
<?xml version="1.0" encoding="UTF-8"?>
<streaming>
  <service>
    <name>My Streaming Service</name>
    <servers>
      <server>
        <name>My Streaming Server</name>
        <url>rtmp://my.streaming-server.com/live</url>
      </server>
    </servers>
    <profiles>
      <profile>
        <name>My Streaming Quality</name>
        <config resolution="1080p" fps="60" codec="H264">
          <bitrate>7500000</bitrate>
        </config>
      </profile>
    </profiles>
  </service>
</streaming>
```

Streaming XML Definition

The Streaming XML file follows standard XML format and shall begin with XML declaration.

```
<?xml version="1.0" encoding="UTF-8"?>
```

Streaming Element

The Streaming XML file shall be contained by the <streaming> element. The <streaming> element will consist of 1 or more <service> child elements.

The following is an example of a <streaming> element block that defines 2 streaming services.

```
<streaming>
  <service>
    <name>Service 1</name>
    <!-- Streaming settings for "Service 1" -->
  </service>
  <service>
    <name>Service 2</name>
    <!-- Streaming settings for "Service 2" -->
  </service>
</streaming>
```

Service Element

The <service> element provides a description of the streaming service. If multiple streaming services are used, it is possible to define multiple <service> elements within each <streaming> element block.

The following is an example of a <service> element block in the Stream XML file.

```
<streaming>
  <service customizable-url="true">
    <name>My Streaming Service</name>
    <key>abc1-def2-ghi3-jkl4-mno5</key>
    <servers>
      <!-- Streaming server settings -->
    </servers>
    <profiles default="Streaming High">
      <!-- Streaming quality settings-->
    </profiles>
    <credentials>
      <!-- Streaming username and password settings -->
    </credentials>
  </service>
  <!-- <service> elements blocks for other streaming services -->
</streaming>
```

Attributes

Attribute	Optional/Required	Description
customizable-url	Optional	The service supports specifying custom URLs - supported = "true" or unsupported = "false" (default)

Child Elements

Element	Optional/Required	Description
<name>	Required	The name of the streaming service
<key>	Optional	The stream key for the streaming service
<servers>	Optional	The RTMP/SRT server settings of the streaming service (see below). May be omitted if customizable-url is true.
<profiles>	Required	The quality settings of the streaming service (see below)
<credentials>	Optional	The username and password of the streaming service (see below)

Servers Element

The <servers> element consists of 1 or more <server> child elements for defining the streaming server(s). The <servers> element is a required child of the <service> element. Defining multiple servers allows specifying localized and/or backup servers within a single XML description

The following is an example of a <servers> element block that defines a primary and secondary URL for the SRT server.

```
<service>
  ...
  <servers>
    <server group="Primary">
      <name>My Streaming Service Server</name>
      <url>srt://srt.my-streaming-service.com:2010</url>
      <srt-extensions>
        ...
      </srt-extensions>
    </server>
    <server group="Secondary">
      <name>My Streaming Service Backup Server</name>
      <url>srt://srt-backup.my-streaming-service.com:2010</url>
      <srt-extensions>
        ...
      </srt-extensions>
    </server>
    <!-- Additional <server> element blocks defining other
servers for streaming service -->
  </servers>
  ...
</service>
```

Attributes

Attribute	Optional/Required	Description
group	Optional	The logical grouping for the server

Child Elements

Element	Optional/Required	Description
<name>	Required	The name of the RTMP/SRT streaming server
<url>	Required	The URL of the RTMP/SRT streaming server
<srt-extensions>	Optional	Extended service block specific to SRT streaming server (see below)

SRT Extensions Element

The <srt-extensions> element consists of 1 or more child elements that define SRT specific parameters.

The following is an example of a <srt-extensions> element block for a primary stream identifier.

```
<service>
  ...
  <servers>
    <server group="Primary">
      ...
      <srt-extensions>
        <stream-id>
          <item key="copy" value="0"/>
        </stream-id>
      </srt-extensions>
    </server>
  </servers>
  ...
</service>
```

Child Elements

Element	Optional/Required	Description
<stream-id>	Required	Provides element with custom parameters for the stream ID. Each child element of stream-id has 1 or more item elements with a key/value pair.

Profiles Element

The <profiles> element consists of 1 or more <profile> child elements that define streaming quality. The <profiles> element is a required child of the <service> element. Defining multiple profiles allows specifying custom bitrates for different streaming qualities.

The following is an example of a <profiles> element block that defines 3 profiles.

```
<service>
  ...
  <profiles default="Streaming High">
    <profile>
      <name>Streaming High</name>
      <!-- Define <config> elements to specify target
bitrates for Streaming High profile -->
    </profile>
    <profile>
      <name>Streaming Medium</name>
      <!-- Define <config> elements to specify target
bitrates for Streaming Medium profile -->
    </profile>
  </profiles>
  ...
</service>
```

Attributes

Attribute	Optional/Required	Description
default	Optional	The name of the default profile

Child Elements

Element	Optional/Required	Description
<name>	Required	The name of the profile
<config>	Required	Video mode dependent quality settings for profile (see below)

Config Element

The <config> element defines a mapping between the video resolution and frame rate and the target bitrate for the quality level. The <config> element is a child of the <profile> element.

The following is an example of a <config> element block for setting the target bitrate for a high quality stream with 720p60 and 1080p60 video inputs.

```
<profile>
  <name>Streaming High</name>
  <config resolution="720p" fps="60" codec="H264">
    <bitrate>6000000</bitrate>
    <audio-bitrate>128000</audio-bitrate>
  </config>
  <config resolution="1080p" fps="60" codec="H264">
    <bitrate>8000000</bitrate>
    <audio-bitrate>128000</audio-bitrate>
  </config>
  <!-- <config> elements for other resolutions and frame rates -->
</profile>
```

Attributes

Attribute	Optional/Required	Description
resolution	Required	The resolution of the streaming video mode
fps	Required	The frame rate of the streaming video mode (frames per second)
codec	Optional	The codec for encoding the streaming video - "H264" (default) or "H265"

Child Elements

Element	Optional/Required	Description
<bitrate>	Required	The target bitrate of the streaming video (bits per second)
<audio-bitrate>	Optional	The target bitrate of the streaming audio (bits per second)

The supported streaming quality bitrates can be found in section `Using Web Presenter Setup` section earlier in this manual.

TIP For each <config> element block, choose a maximum resolution and fps to cover all video modes for the target bitrate. For example, defining a <config> element with resolution="1080p" and fps = "30" will apply for video modes 1080p23.98, 1080p24, 1080p25, 1080p29.97 and 1080p30.

For audio bitrate, only 128 Kb/s is supported.

Credentials Element

The <credentials> element allows specifying an RTMP session username and password if required by the service. The <credentials> element is an optional child to service element.

The following is an example of a <credentials> element block that defines a username and password for the streaming service.

```
<service>
  ...
  <credentials>
    <username>myusername</username>
    <password>abcd1234</password>
  </credentials>
  ...
</service>
```

Child Elements

Element	Optional/Required	Description
<username>	Required	RTMP session username
<password>	Required	RTMP/SRT session password

Assistance

Obtenir de l'aide

Le moyen le plus rapide d'obtenir de l'aide est de consulter les pages d'assistance en ligne de Blackmagic Design et de consulter les informations les plus récentes concernant votre Blackmagic Web Presenter.

Pages d'assistance en ligne de Blackmagic Design

Les dernières versions du manuel peuvent être consultées sur la page d'assistance technique de Blackmagic Design : www.blackmagicdesign.com/fr/support

Forum Blackmagic Design

Le forum Blackmagic Design est une source d'information utile qui offre des idées innovantes pour vos productions. Cette plateforme d'aide vous permettra également d'obtenir des réponses rapides à vos questions, car un grand nombre de sujets peuvent avoir déjà été abordés par d'autres utilisateurs. Pour vous rendre sur le forum : <http://forum.blackmagicdesign.com>

Contactez le service d'assistance de Blackmagic Design

Si vous ne parvenez pas à trouver l'aide dont vous avez besoin dans nos pages d'aide ou sur les forums, veuillez utiliser l'option « Envoyer un email », accessible sur la page d'assistance pour envoyer une demande d'assistance par email. Vous pouvez également cliquer sur le bouton « Trouver un support technique » situé sur la page d'assistance et contacter ainsi le centre de support technique Blackmagic Design le plus proche de chez vous.

Avis réglementaires



Élimination des déchets d'équipements électriques et électroniques au sein de l'Union européenne.

Le symbole imprimé sur ce produit indique qu'il ne doit pas être jeté avec les autres déchets. Cet appareil doit être déposé dans un point de collecte agréé pour être recyclé. Le tri, l'élimination et le recyclage séparés de vos équipements usagés permettent de préserver les ressources naturelles et d'assurer le recyclage de ces équipements dans le respect de l'homme et de l'environnement. Pour obtenir plus d'informations sur les points de collecte pour recycler votre appareil, veuillez contacter l'organisme responsable du recyclage dans votre région ou le revendeur du produit.



Cet équipement a été testé et déclaré conforme aux limites imposées aux appareils numériques de classe A, en vertu du chapitre 15 des règles de la FCC. Ces limites ont pour objectif d'assurer une protection suffisante contre les interférences nuisibles lorsque l'équipement est utilisé dans un environnement commercial. Cet appareil génère, utilise et émet de l'énergie de fréquences radio et peut, en cas d'installation ou d'utilisation non conforme aux instructions, engendrer des interférences nuisibles au niveau des communications radio. L'utilisation de cet équipement en zone résidentielle est susceptible de provoquer des interférences nuisibles, auquel cas il sera demandé à l'utilisateur de corriger ces interférences à ses frais.

L'utilisation de cet appareil est soumise aux deux conditions suivantes :

- 1 Cet appareil ne doit pas causer d'interférences nuisibles.
- 2 Cet appareil doit accepter toute interférence reçue, y compris les interférences pouvant entraîner un dysfonctionnement.



R-R-BMD-20201201001
R-R-BMD-20201201002

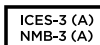

Déclaration de ISDE Canada

Cet appareil est conforme aux normes canadiennes relatives aux appareils numériques de Classe A.

Toute modification ou utilisation de ce produit en dehors de son utilisation prévue peut annuler la conformité avec ces normes.

Les connexions aux interfaces HDMI doivent être effectuées avec des câbles HDMI blindés d'excellente qualité.

Cet équipement a été testé pour être en conformité avec une utilisation prévue dans un environnement commercial. Si cet équipement est utilisé dans un environnement domestique, il peut provoquer des interférences radio.

Informations de sécurité

Cet appareil doit être connecté à une prise secteur équipée d'un conducteur de protection.

Afin de réduire le risque de décharge électrique, ne pas éclabousser ou renverser de liquide sur cet appareil.

Cet appareil peut être utilisé dans un climat tropical lorsque la température ambiante n'excède pas 40°C.

La température de stockage est comprise entre -20°C et 60°C et l'humidité relative entre 0% et 90% sans condensation.

Veillez à ce que l'espace autour du produit soit suffisant afin de ne pas compromettre la ventilation.

Lorsque vous installez l'appareil sur rack, veillez à ce que la ventilation ne soit pas compromise par les autres équipements.

Les pièces de cet appareil ne sont pas réparables par l'opérateur. Toute réparation/opération d'entretien doit être effectuée par un centre de service Blackmagic Design.



Cet appareil doit être utilisé à une altitude inférieure à 2000 mètres.

Déclaration de l'État de Californie

Ce produit est susceptible de vous exposer à des produits chimiques, dont des traces de polybromobiphényle dans les parties en plastique, reconnu par l'État de Californie comme étant responsable de cancers, d'anomalies congénitales ou d'autres effets nocifs sur la reproduction.

Pour de plus amples informations, veuillez vous rendre sur www.P65Warnings.ca.gov.

Garantie

Garantie limitée à 36 mois

Par la présente, Blackmagic Design garantit que le Blackmagic Web Presenter sera exempt de défauts matériels et de fabrication pendant une durée de 36 mois à compter de la date d'achat, ceci excluant les connecteurs, câbles, ventilateurs, modules à fibre optique, fusibles, claviers et batteries qui seront exempts de défauts matériels et de fabrication pendant une durée de 12 mois à compter de la date d'achat. Si le produit s'avère défectueux pendant la période de garantie, Blackmagic Design peut, à sa seule discrétion, réparer le produit défectueux sans frais pour les pièces et la main-d'œuvre, ou le remplacer.

Pour se prévaloir du service offert en vertu de la présente garantie, il vous incombe d'informer Blackmagic Design de l'existence du défaut avant expiration de la période de garantie, et de prendre les mesures nécessaires pour l'exécution des dispositions de ce service. Le consommateur a la responsabilité de s'occuper de l'emballage et de l'expédition du produit défectueux au centre de service nommé désigné par Blackmagic Design, en frais de port prépayé. Il incombe au consommateur de payer tous les frais de transport, d'assurance, droits de douane et taxes et toutes autres charges relatives aux produits qui nous auront été retournés et ce, quelle que soit la raison.

La présente garantie ne saurait en aucun cas s'appliquer à des défauts, pannes ou dommages causés par une utilisation inappropriée ou un entretien inadéquat ou incorrect. Blackmagic Design n'a en aucun cas l'obligation de fournir un service en vertu de la présente garantie : a) pour réparer les dommages résultant de tentatives de réparations, d'installations ou tous services effectués par du personnel non qualifié par Blackmagic Design, b) pour réparer tout dommage résultant d'une utilisation inadéquate ou d'une connexion à du matériel incompatible, c) pour réparer tout dommage ou dysfonctionnement causé par l'utilisation de pièces ou de fournitures n'appartenant pas à la marque de Blackmagic Design, d) pour examiner un produit qui a été modifié ou intégré à d'autres produits quand l'impact d'une telle modification ou intégration augmente les délais ou la difficulté d'examiner ce produit. CETTE GARANTIE REMPLACE TOUTE GARANTIE EXPLICITE OU TACITE. BLACKMAGIC DESIGN ET SES REVENDEURS DÉCLINENT EXPRESSÉMENT TOUTE GARANTIE IMPLICITE DE COMMERCIALISATION OU D'ADAPTATION QUEL QU'EN SOIT LE BUT. LA RESPONSABILITÉ DE BLACKMAGIC DESIGN POUR RÉPARER OU REMPLACER UN PRODUIT S'AVÉRANT DÉFECTUEUX CONSTITUE LA TOTALITÉ ET LE SEUL RECOURS EXCLUSIF PRÉVU ET FOURNI AU CONSOMMATEUR POUR TOUT DOMMAGE INDIRECT, SPÉCIFIQUE, ACCIDENTEL OU CONSÉCUTIF, PEU IMPORTE QUE BLACKMAGIC DESIGN OU SES REVENDEURS AIENT ÉTÉ INFORMÉS OU SE SOIENT RENDU COMPTE AU PRÉALABLE DE L'ÉVENTUALITÉ DE CES DOMMAGES. BLACKMAGIC DESIGN NE PEUT ÊTRE TENU POUR RESPONSABLE DE TOUTE UTILISATION ILLICITE DU MATÉRIEL PAR LE CONSOMMATEUR. BLACKMAGIC DESIGN N'EST PAS RESPONSABLE DES DOMMAGES RÉSULTANT DE L'UTILISATION DE CE PRODUIT. LE CONSOMMATEUR UTILISE CE PRODUIT À SES SEULS RISQUES.

© Copyright 2023 Blackmagic Design. Tous droits réservés. 'Blackmagic Design', 'DeckLink', 'HDLink', 'Workgroup Videohub', 'Multibridge Pro', 'Multibridge Extreme', 'Intensity' et 'Leading the creative video revolution' sont des marques déposées aux États-Unis et dans d'autres pays. Tous les autres noms de société et de produits peuvent être des marques déposées des sociétés respectives auxquelles ils sont associés.

Thunderbolt et le logo Thunderbolt sont des marques d'Intel Corporation aux États-Unis et/ou dans d'autres pays.

September 2023

Installations- und Bedienungsanleitung

Blackmagicdesign

Blackmagic Web Presenter



Blackmagic Web Presenter



Lieber Kunde, liebe Kundin!

Vielen Dank, dass Sie sich zum Kauf eines Blackmagic Web Presenters entschieden haben.

Der Blackmagic Web Presenter lässt sich direkt an sämtliches SDI-Equipment anschließen, konvertiert Signale in H.264 und ermöglicht das Streamen an gängige Streaming-Dienste wie YouTube Live, Facebook Live und Twitch. Außerdem können Sie Video mithilfe einer optional erhältlichen ATEM Streaming Bridge in Broadcastqualität von Punkt zu Punkt übertragen. Die Internetübertragung von professionellem Video an entfernte Standorte ist so ein Leichtes.

Diese Bedienungsanleitung beinhaltet alles, was Sie brauchen, um Ihren Blackmagic Web Presenter in Gebrauch zu nehmen. Sie erfahren, wie Sie alle Features und Bedienelemente nutzen, wie Sie das Gerät für YouTube Live, Facebook Live, Twitch, Zoom, Skype einrichten und mehr.

Sehen Sie auf der Support-Seite unter www.blackmagicdesign.com/de nach der aktuellsten Ausgabe der Bedienungsanleitung sowie Aktualisierungen der Produktsoftware Ihres Blackmagic Web Presenters. Registrieren Sie sich beim Herunterladen der Software mit Ihren Kontaktdaten, damit wir Sie über neue Softwareveröffentlichungen informieren können.

Wir arbeiten ständig an neuen Features und Verbesserungen und freuen uns über Feedback von Ihnen!

A handwritten signature in black ink that reads "Grant Petty". The signature is written in a cursive, flowing style.

Grant Petty

CEO Blackmagic Design

Inhaltsverzeichnis

Erste Schritte	164
Verwenden der Frontblende am Web Presenter	167
LC-Display	168
Verwenden der Monitoring-Ausgabe	169
Verwenden von Web Presenter Setup	174
Der Reiter „Live Stream“	175
Der Reiter „Setup“	178
Netzwerkeinstellungen	179
Internetfreigabe fürs Direktstreaming	179
Streaming mithilfe Ihres Smartphones	180
Verwenden des Blackmagic Web Presenter HD als Webcam	180
Einrichten von Open Broadcaster	180
Videolinks mit einer ATEM Streaming Bridge	183
Erstellen der XML-Datei	184
Exportieren der XML-Datei	184
Tally, Talkback und Kamerasteuerung	185
Verbinden mit der URSA Broadcast G2	186
Blackmagic Universal Rack Shelf	187
Inhalt	187
Montage von Geräten in das Rack	188
So bringen Sie eine 1/6-Blindplatte an:	188
So bringen Sie eine 1/3-Blindplatte an der Seite an:	188
Aktualisieren der Produktsoftware	189
Informationen für Entwickler (Englisch)	190
Blackmagic Web Presenter Ethernet Protocol	190
Protocol Blocks	192
Blackmagic Streaming XML Format	203
Overview	203
Streaming XML Definition	203
Hilfe	210
Gesetzliche Vorschriften	211
Sicherheitshinweise	212
Garantie	213

Erste Schritte

Der Einstieg in die Arbeit mit Ihrem Blackmagic Web Presenter ist ganz einfach! Sie müssen bloß ein Stromkabel einstecken, Ihre Video- und Audioquelle anschließen, das Gerät mit Ihrem Computer verbinden und es dann mit dem Internet verbinden.

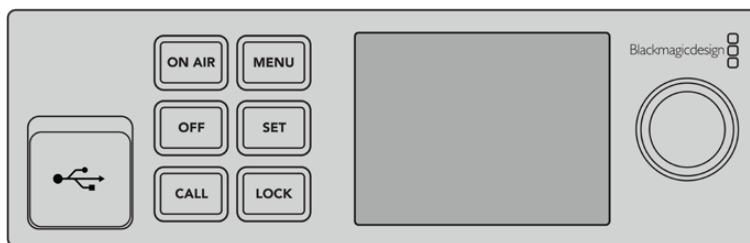

Frontblende des Blackmagic Web Presenters

Anschließen an das Stromnetz

Schließen Sie die Strombuchse am Geräte Rücken Ihres Blackmagic Web Presenters über ein standardmäßiges IEC-Netzka bel ans Stromnetz an.

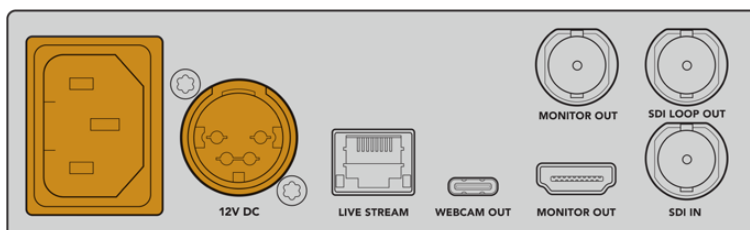

Der Web Presenter kann wahlweise über den IEC- oder einen der 12V-DC-Stromeingänge mit Strom versorgt werden

Der Web Presenter verfügt über einen zusätzlichen 12V-DC-Stromeingang. An diesen Eingang können Sie eine externe Stromquelle oder Redundanz für ein externes Netzteil anschließen, bspw. eine unterbrechungsfreie Stromversorgung (UVS) oder einen externen 12V-Akku.

Anschließen von Video- und Audiogeräten

Schließen Sie Ihre Videoquelle an den SDI-Eingang des Blackmagic Web Presenters an. Sobald Ihr Video verbunden ist, wird es auf dem eingebauten LCD Ihres Web Presenters angezeigt. Der Ton wird mit dem Video ins SDI-Videosignal eingebettet und kann anhand der Audiopegelmeter auf dem LCD geprüft werden.

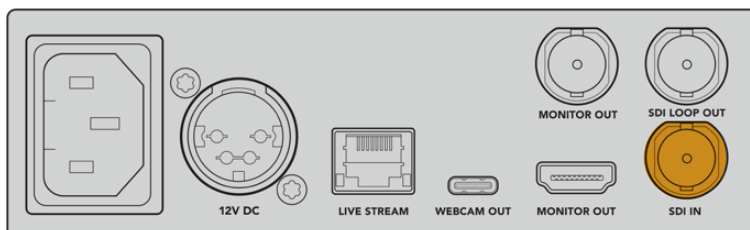

Schließen Sie Ihre Videoquelle an den SDI-Eingang des Blackmagic Web Presenters an

Der Blackmagic Web Presenter unterstützt 12G-SDI. Wechselt das eingehende Videosignal, schaltet er automatisch zwischen HD- und Ultra-HD-Formaten bis 2160p/60 um. Während der Blackmagic Web Presenter 4K in Ultra HD streamt, kann der Blackmagic Web Presenter HD mit buchstäblich jedem Videosignal arbeiten und es auf 1080p downkonvertieren.

Anschließen eines Monitors

Schließen Sie Ihren HDMI-Fernseher oder SDI-Monitor an einen der Monitoring-Ausgänge an. So können Sie Ihre Übertragung prüfen und wichtige Statusinformationen überwachen, die sich fortlaufend mit dem Videostream aktualisieren. Einzelheiten zur Verwendung der Monitoring-Ausgabe finden Sie im Abschnitt „Verwenden der Monitoring-Ausgabe“.

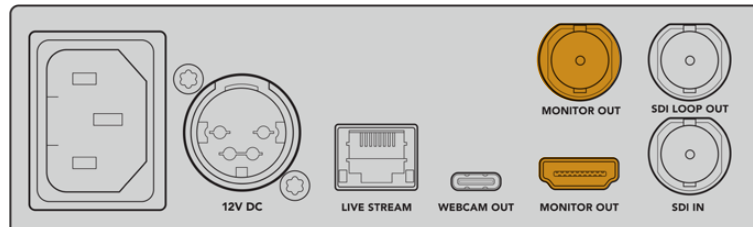

Verbinden Sie einen Monitor mit dem Monitoring-Ausgang Ihres Web Presenters

Anschließen an einen Computer per USB

Verbinden Sie Ihren Web Presenter über den vorder- oder rückseitigen USB-C-Port mit Ihrem Computer. Die USB-Ports dienen zum Konfigurieren des Geräts mit dem Dienstprogramm Blackmagic Web Presenter Setup und zum Aktualisieren. Nach der erstmaligen Konfiguration Ihres Web Presenters können Sie das Gerät vom Computer trennen.

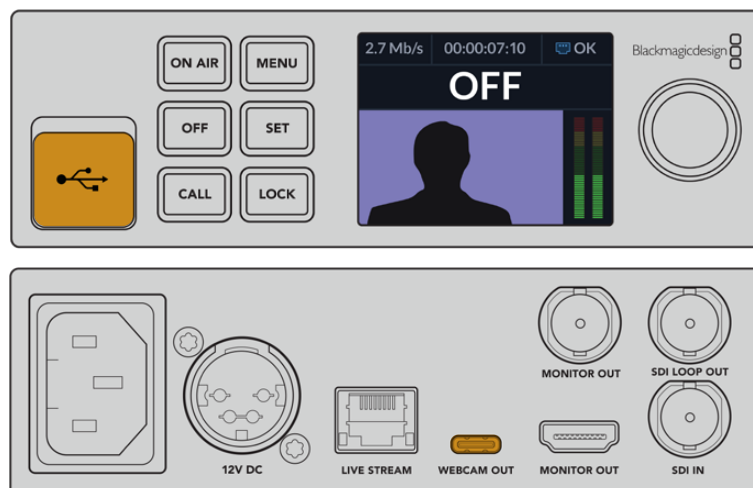

Verbinden Sie Ihren Blackmagic Web Presenter über den vorder- oder rückseitigen USB-Port mit Ihrem Computer

Verbinden mit dem Internet

Verbinden Sie Ihren Blackmagic Web Presenter mit dem Internet, indem Sie ein Netzkabel vom „Livestream“-Ethernet-Port zu einem Internetrouter oder Netzwerk-Switch anschließen.

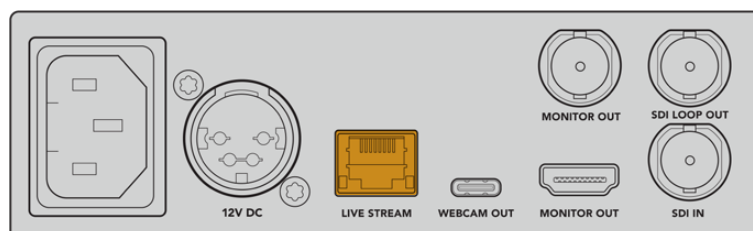

Verbinden Sie Ihren Blackmagic Web Presenter über den rückseitigen Ethernet-Port mit Ihrem Netzwerk

Einrichten eines Livestreams

Jetzt können Sie Ihren Web Presenter so einrichten, dass er über jede beliebige Streaming-Plattform wie YouTube Live, Facebook Live, Twitch und weitere streamt. Im folgenden Beispiel richten wir einen Stream für YouTube Live ein.

- 1 Kopieren Sie Ihren Streamschlüssel aus Ihrem YouTube-Konto.
- 2 Laden Sie das Dienstprogramm Blackmagic Web Presenter Setup unter www.blackmagicdesign.com/de/support herunter und installieren Sie es auf Ihrem Computer. Mit der Software können Sie die Streaming-Einstellungen erstmalig konfigurieren.
- 3 Starten Sie das Dienstprogramm Blackmagic Web Presenter Setup und gehen Sie zum Reiter „Live Stream“.
- 4 Wählen Sie als Plattform „YouTube“ und als Server „Primary“ aus. Fügen Sie Ihren Streamschlüssel in das Feld „Key“ ein und geben Sie die Streaming-Qualität vor. Klicken Sie auf „Save“.
- 5 Jetzt sind Sie startklar, um in die Welt zu streamen! Tippen Sie auf den ON-AIR-Button auf dem LCD oder drücken Sie die gleichnamige Taste an der Frontblende des Geräts. Am Ende Ihrer Sendung stoppen Sie die Übertragung durch Drücken der OFF-Taste.

Verwenden des SRT-Streaming Protokolls

Im Vergleich zu RTMP bietet das SRT-Protokoll (Secure Reliable Transport Protocol) eine geringere Latenzzeit beim Streaming. Durch die Verwendung einer Passphrase, die wie ein Verschlüsselungsschlüssel funktioniert, erhöht SRT auch die Sicherheit.

Bei der Auswahl der SRT-Protokoll-Version Ihres Streaming-Dienstes, kopieren Sie die Passphrase und den Streamschlüssel von Ihrem Streaming-Konto. Fügen Sie diese dann in die Felder „Key“ und „Passphrase“ des Blackmagic Web Presenter Setup Dienstprogramms ein.

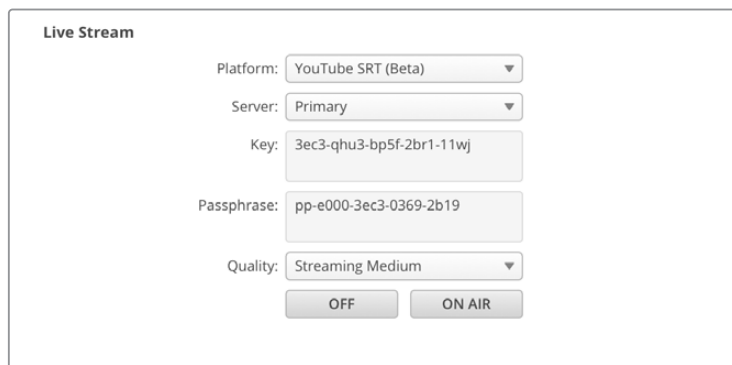

The screenshot shows a window titled "Live Stream" with the following configuration options:

- Platform: YouTube SRT (Beta)
- Server: Primary
- Key: 3ec3-qhu3-bp5f-2br1-11wj
- Passphrase: pp-e000-3ec3-0369-2b19
- Quality: Streaming Medium

At the bottom of the window, there are two buttons: "OFF" and "ON AIR".

Fügen Sie die Passphrase in das „Passphrase“-Feld des Setup-Dienstprogramms ein

Um die Streaming-Einstellungen anzupassen, können technisch versierte Broadcaster sowohl das Protokoll RTMP und SRT als auch den Codec H.264 und H.265 in der XML-Datei ändern. Weitere Informationen finden Sie im Abschnitt „Blackmagic Streaming XML Format“.

Verwenden der Frontblende am Web Presenter

Mit den Bedienelementen an der Frontblende des Blackmagic Web Presenters starten und beenden Sie den Stream und ändern Einstellungen.



ON AIR – Um den Stream zu starten, drücken Sie einfach die ON-AIR-Taste. Während der Stream live ist, leuchtet die Anzeige rot.



Eine blinkende ON-AIR-Taste bedeutet, dass der Start eines Livestreams fehlgeschlagen ist oder der Livestream unerwartet abgebrochen wurde. Dies mag auf ein Problem mit der Internetverbindung oder mit den Streaming-Einstellungen zurückzuführen sein. Prüfen Sie, dass eine Internetverbindung besteht und Ihre Streaming-Einstellungen korrekt sind.

OFF – Um den Stream zu stoppen, drücken Sie die OFF-Taste.

MENU – Drücken Sie die MENU-Taste, um das Einstellungs Menü auf dem LCD aufzurufen.

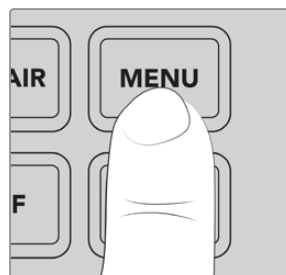

So ändern Sie Einstellungen:

- 1 Markieren Sie die zu ändernde Einstellung durch Drehen des Reglers und drücken Sie dann die SET-Taste.

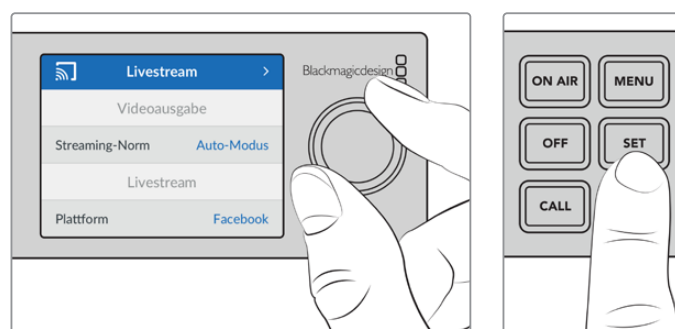

- 2 Drehen Sie den Regler, um die Einstellung zu ändern.
- 3 Bestätigen Sie die Änderung durch erneutes Drücken der SET-Taste.

Mit der MENU-Taste kehren Sie zu den Menüoptionen auf den Ebenen darüber und schließlich zum Homescreen zurück.

CALL – Diese Funktion wird mit einem künftigen Softwareupdate bereitgestellt.

LOCK – Um die Frontblende zu sperren, halten Sie diese Taste 1 Sekunde lang gedrückt. Dies deaktiviert alle Tasten und verhindert, dass andere versehentlich auf Sendung gehen oder einen Stream stoppen. Im aktivierten Zustand leuchtet die LOCK-Taste rot.

Um die Frontblende zu entsperren, halten Sie die Taste 2 Sekunden lang gedrückt.

LC-Display

Der Homescreen ist das Merkmal, das Ihnen beim Hochfahren Ihres Web Presenters als Erstes auffallen wird. Der Homescreen zeigt Ihnen u. a. folgende wichtige Informationen an:

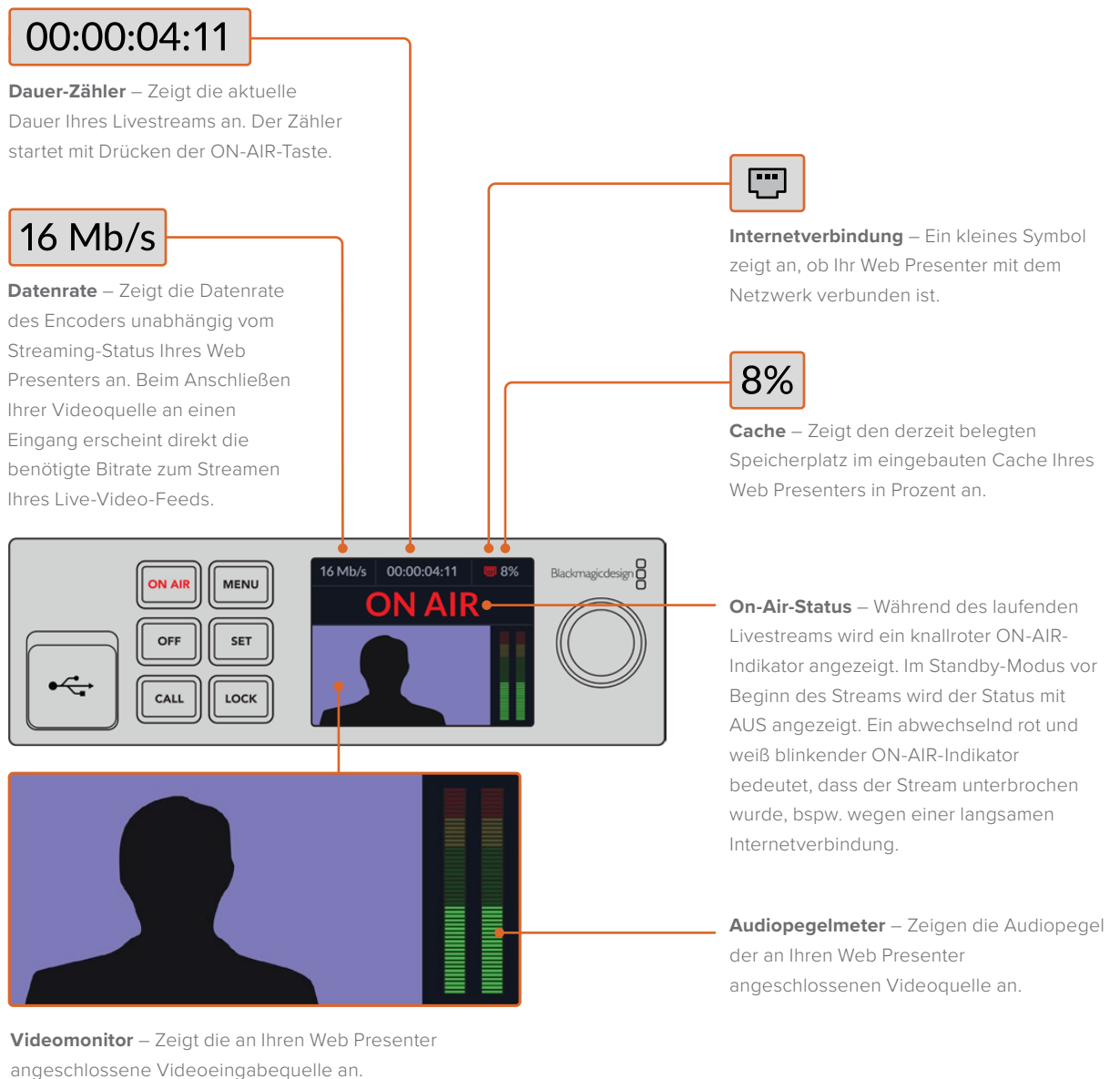

Symbole zur Internetverbindung



Das blaue Ethernet-Symbol zeigt an, dass ein Ethernet-Kabel angeschlossen ist und fürs Streaming die Ethernet-Verbindung verwendet wird.



Das rote Ethernet-Symbol zeigt an, dass das Gerät on air ist und per Ethernet streamt.



Das blaue Handysymbol zeigt an, dass fürs Streaming eine von einem Smartphone freigegebene Internetverbindung verwendet wird.



Das rote Handysymbol zeigt an, dass das Gerät on air ist und fürs Streaming eine von einem Smartphone freigegebene Internetverbindung verwendet wird.

TIPP Wenn kein Symbol erscheint, ist Ihr Web Presenter nicht mit dem Netzwerk verbunden.

Verwenden der Monitoring-Ausgabe

Über die Monitoring-Ausgabe können Sie Videoeingabe, Audiopegel, On-Air-Status, Datenrate und Cache-Stand sowie technische Informationen zur SDI-Eingabe überwachen.



Die Monitoring-Ausgabe am Blackmagic Web Presenter liefert umfassende Informationen, u. a. zu Datenrate und Cache-Status

Die Monitoring-Ausgabe besteht aus acht Bereichen. Nachstehend werden die einzelnen Bereiche und die dort angezeigten Informationen beschrieben.

Eingabe-Ansicht

Der größte Bereich zeigt das aktuell von der angeschlossenen SDI-Videoquelle eingehende Video an.



On-Air-Status

Vor dem Streamen steht der ON-AIR-Statusindikator auf AUS. Dies signalisiert, dass der Web Presenter sich im Standby-Modus befindet und sendebereit ist. Ab Beginn des Streamens leuchtet der ON-AIR-Statusindikator so lange rot, bis der Stream gestoppt wird.

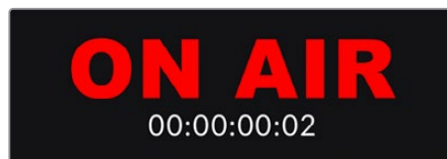

Dieser Zähler befindet sich unterhalb des ON-AIR-Indikators. Der Zähler startet, sobald die ON-AIR-Taste am Web Presenter gedrückt wird.

Wenn Ihr Web Presenter off air ist, aber über Smartphone-Tethering streamen soll, erscheint in der oberen rechten Ecke des OFF-Indikators ein blaues Handysymbol. Ist das Gerät on air, ist das Handysymbol rot.

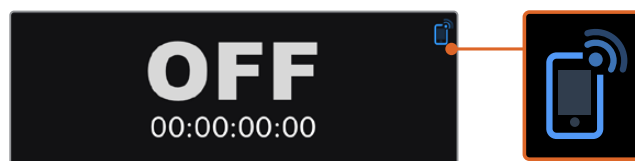

Livestream

Das „Livestream“-Fenster zeigt Informationen zu Ihren Livestream-Einstellungen an. Dazu gehören die Streaming-Plattform, der Server und das Protokoll. Zudem werden die Streamauflösung und die Qualitätseinstellungen angezeigt.

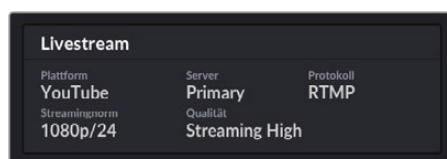

Videoeingabe

Fünf Mini-Viewer am oberen Rand des Videoeingabe-Bereichs zeigen die letzten 6 Sekunden Ihres Livestreams. Jeder Viewer bildet jeweils 1,2 Sekunden davon ab.

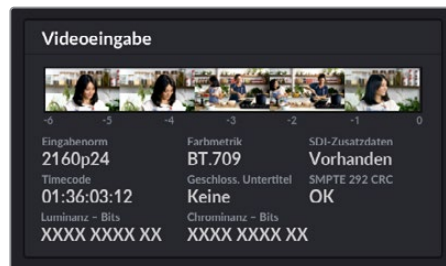

Unterhalb der Mini-Viewer sehen Sie detaillierte technische Informationen zur Videoquelle, die an den SDI-Eingang Ihres Web Presenters angeschlossen ist.

Eingabennorm	Zeigt die Auflösung und Bildwechselfrequenz der SDI-Videoeingabe. Der Web Presenter unterstützt Frameraten bis 2160p/60.
Kolorimetrie	Zeigt den Farbraum der SDI-Videoeingabe. Der Web Presenter unterstützt die Farbräume Rec. 601, Rec. 709 und Rec. 2020.
SDI-Zusatzdaten	Neben dem Video überträgt die SDI-Videoeingabe weitere Daten. Diese umfassen eingebettetes Audio, Timecode und geschlossene Untertitel. Falls Ihre SDI-Eingabe zusätzliche Daten übermittelt, wird unter diesem Punkt „Vorhanden“ angezeigt.
Timecode	Zeigt den Timecode der SDI-Videoeingabequelle an.
Geschlossene Untertitel	Wenn Ihre SDI-Videoeingabe geschlossene Untertitel beinhaltet, wird hier das Format angezeigt. Unterstützt werden CEA-608- und CEA-708-Formate.
SMPTE 292 CRC	Dies ist eine Fehlerüberprüfungsfunktion für SDI-Video. Wenn ihr Web Presenter ein Problem mit der SDI-Videoeingabe erkennt, wird ein Fehler angezeigt. Die meisten CRC-Fehler sind auf fehlerhafte oder übermäßig lange SDI-Kabel zurückzuführen.
Luminanz (Y) – Bits und Chrominanz – Bits	<p>Die Indikatoren für „Luminanz (Y) – Bits“ und „Chrominanz – Bits“ zeigen die Aktivität des SDI-Signals der Videoeingabe. Jeder Buchstabe steht für den Zustand eines Bits im Videosignal.</p> <p>X – Ein „X“ steht für ein sich ständig veränderndes Bit</p> <p>L – Ein „Low“- oder „0“-Bit</p> <p>H – Ein „High“- oder „1“-Bit</p> <p>Zum besseren Verständnis werden SDI-Offsets subtrahiert, bspw. sind bei schwarzem Video alle Bits „Low“.</p> <p>Grundsätzlich werden alle 10 Bits Ihrer SDI-Videoeingabe mit einem „X“ angezeigt. Sie verweisen auf ständige Veränderungen der Bits in Ihrem Videostream. Verwenden Sie 8-Bit-Video für die SDI-Eingabe, werden die beiden Bits ganz rechts immer mit einem „L“ angezeigt, weil sie keine Daten aufweisen. Bleibt ein Bit bei „L“ oder „H“ stehen, wenn der Zustand eigentlich „X“ sein sollte, könnte das Bit infolge eines Fehlers mit dem Upstream-Video „haken“.</p>

Audioeingabe

Die Audio-Waveform-Anzeige am oberen Rand des Audioeingabe-Bereichs zeigt Audioinformationen der letzten 6 Sekunden Ihres Streams an. Sie aktualisiert sich ständig und läuft von rechts nach links.

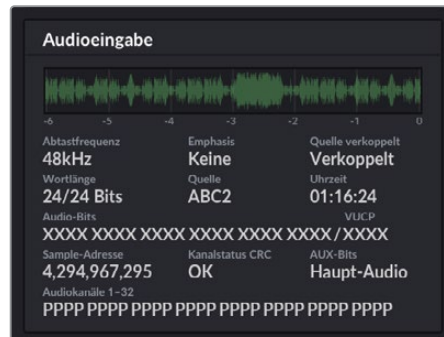

Unterhalb der Audio-Waveform-Anzeige erscheinen detaillierte technische Informationen zur Audioeingabe.

Abtastfrequenz	Zeigt die Abtastrate des in die SDI-Eingabe eingebetteten Audios ein.
Emphasis	Zeigt an, ob für die Audioquelle die Option „Emphasis“ aktiviert ist.
Quelle verkoppelt	Zeigt an, ob die Frequenz der Audioquelle mit einer externen Referenzquelle verkoppelt ist.
Wortlänge	Zeigt die Bittiefe des in die SDI-Eingabe eingebetteten Audios an.
Quelle	Diese vier Zeichen verweisen auf die Quelle des Kanals.
Uhrzeit	Frei laufender Timecode.
Audio-Bits	Zeigt die Bitaktivität in den Audio-Samples an, die in die SDI-Verbindung eingebettet sind. Der Status des Audiokanals gibt an, ob Ihr Audio 16, 20 oder 24 Bit aufweist. Die Audio-Bitaktivität bestätigt dies zusätzlich.
VUCP	Von links nach rechts gelesen stehen VUCP-Bits für „Valid“ (gültig), „User“ (Nutzer), „Channel Status“ (Kanalstatus) und „Parity“ (Parität). Das Feld ist ähnlich wie „Audio-Bits“.
Sample-Adresse	Audiosample-Zähler.
AUX-Bits	Zeigt, ob fürs Hauptaudio Aux-Bits verwendet werden.
Audiokanäle 1–32	Jede Stelle steht für einen in die SDI-Eingabe eingebetteten Audiokanal. „P“ steht für einen belegten Audiokanal und „-“ für einen Kanal ohne Audio.

Datenratenanzeige

Die Datenratenanzeige zeigt die aktuelle Datenrate des Encoders über die letzten 60 Sekunden hinweg. Die Datendurchsatzrate wird in Megabits pro Sekunde angegeben. Damit Sie die Bandbreite vor dem Streamen genau einschätzen können, läuft der Indikator auch off air konstant weiter.

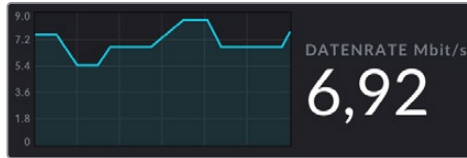

Cache-Anzeige

Die Cache-Anzeige zeigt den derzeit belegten Speicherplatz des in den Web Presenter HD integrierten Pufferspeichers in Prozent an, und der Graph den in den letzten 60 Sekunden verbrauchten Speicherplatz. Der Cache ist ein kleiner interner Speicher, der unaufhörlich aufzeichnet und die Programmausgabe wiedergibt. Wenn die Streaming-Datenrate unter ein für Video benötigtes Niveau sinkt, fungiert der Cache als Sicherheitsmaßnahme.

Schwankende Internetverbindungen sind vorrangig durch die Netzwerkauslastung oder Funksignalstärke bedingt. Sobald die Übertragungsdatenrate abnimmt, puffert der Cache mehr Daten. Sinkt die Datenübertragungsrate unter die für den Videostream benötigte Geschwindigkeit, gleicht der Cache das durch Zwischenspeichern der Videobilder aus. Sobald der Cache zu 100 % ausgelastet ist, leidet die Streamqualität. Vermeiden Sie es deshalb tunlichst, den Cache ganz voll werden zu lassen. Testen Sie dies, indem Sie einen Video-Feed anschließen und die Cache-Anzeige auf der Monitoring-Ausgabe beobachten, ohne den Stream zu starten. Wenn sich der Cache häufig der 100-Prozentmarke nähert, geben Sie in den Livestream-Einstellungen eine geringere Qualitätsstufe vor.

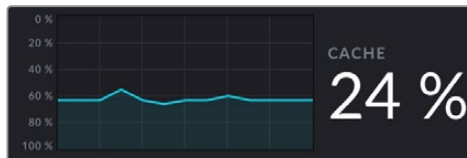

Audiometer

Anhand der Audiopegelmeter können Sie die Pegel Ihrer Audioquelle überprüfen. In den Menü-Einstellungen des Web Presenters können die Pegel entweder auf PPM oder VU eingestellt werden. Sind Ihre Audiopegel zu hoch, leuchten die Meter rot. Dies kann bedeuten, dass es zu Verzerrungen oder Clipping des Tons in Ihrem Livestream kommen kann. Halten Sie Ihr Audio idealerweise im oberen Abschnitt des grünen Balkenbereichs mit gelegentlichen Ausschlägen in den gelben Bereich.

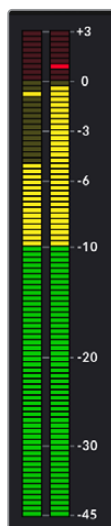

Verwenden von Web Presenter Setup

Wenn Ihr Blackmagic Web Presenter mit einem Netzwerk verbunden ist, können Sie den Web Presenter von jedem in dieses Netzwerk eingebundenen Computer fernsteuern. Mit Blackmagic Web Presenter Setup haben Sie Zugriff auf die gleichen Bedienelemente und Einstellungen, die über die Frontblende des Geräts verfügbar sind.

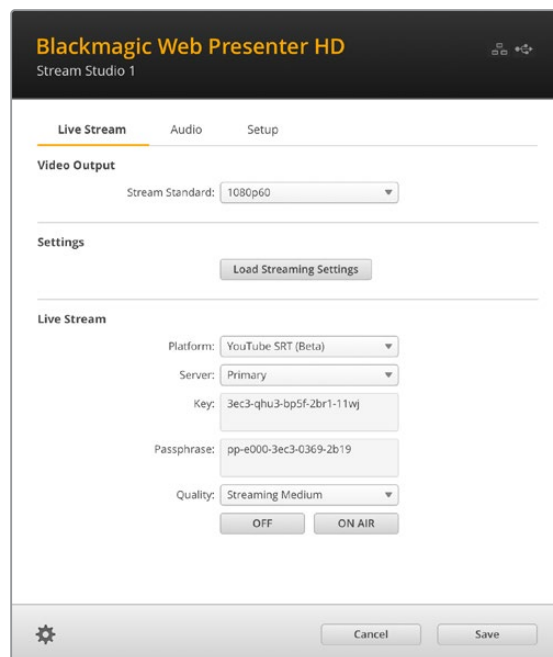
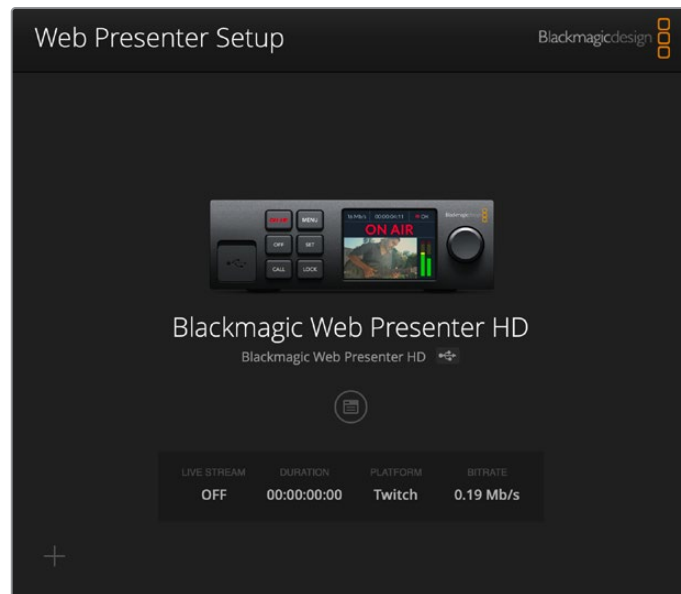

Der Reiter „Live Stream“

Video Output

Stream Standard

Klicken Sie aufs Menü „Stream Standard“ (Streamingnorm), um die Auflösung für Ihren Videostream vorzugeben. Je nach dem von Ihnen verwendeten Web Presenter Modell stehen Normen von 720p/25 bis 1080p/60 zur Verfügung.

Settings

Wenn Sie benutzerdefinierte Streaming-Einstellungen wie bspw. eine XML-Datei von einer Blackmagic ATEM Streaming Bridge verwenden, können Sie diese importieren, indem Sie auf „Load Streaming Settings“ (Streaming-Einstellungen laden) klicken.

Weitere Informationen zum Einrichten benutzerdefinierter Einstellungen und zum Verbinden mit einer ATEM Streaming Bridge finden Sie weiter hinten in diesem Handbuch im Abschnitt „Videolinks mit einer ATEM Streaming Bridge“.

Live Stream

Plattform

Klicken Sie aufs Menü „Plattform“ und wählen Sie dort die Streaming-Plattform für Ihre Übertragung. Zur Verfügung stehen u. a. YouTube, Facebook und Twitch. Importierte benutzerdefinierte Streaming-Einstellungen erscheinen ebenfalls unter „Plattform“.

Um zu einer benutzerdefinierten URL zu streamen, wählen Sie eine benutzerdefinierte URL-Option aus dem Menü „Plattform“. Beim Web Presenter 4K können Sie wählen, ob Sie zu einer benutzerdefinierten URL mit H.264 oder H.265 streamen möchten, beim Web Presenter HD können Sie zu einer benutzerdefinierten URL mit H.264 streamen.

Server

Wählen Sie den nächstgelegenen Server zu Ihrem Standort aus der Liste. Abhängig von der ausgewählten Streaming-Plattform werden Ihnen in der Liste unterschiedliche Server angezeigt.

Wenn Sie zu Instagram, Microsoft Teams oder zu einer benutzerdefinierten URL streamen, ist die Serverliste ein bearbeitbares Feld. Geben Sie hier die URL ein, die Ihrem Streaming-Plattformkonto oder den benutzerdefinierten URL-Details zugewiesen wurde.

Key

Geben Sie hier den Streamschlüssel ein, den die Streaming-Plattform Ihrer Übertragung zugewiesen hat.

Passphrase

Wenn Sie einen Streaming-Dienst mit dem SRT-Streaming-Protokoll verwenden, geben Sie die Passphrase ein, die von Ihrem Streaming-Plattformkonto zugewiesen wurde.

Quality

Setzen Sie die Streaming-Qualität je nach dem von Ihnen verwendeten Web Presenter Modell auf HD oder 4K:

H.264	
HD	4K
HyperDeck High 45 to 70 Mb/s	HyperDeck High 95 to 220 Mb/s
HyperDeck Medium 25 to 45 Mb/s	HyperDeck Medium 66 to 150 Mb/s
HyperDeck Low 12 to 20 Mb/s	HyperDeck Low 38 to 80 Mb/s
Streaming High 6 to 9 Mb/s	Streaming High 34 to 51 Mb/s
Streaming Medium 4.5 to 7 Mb/s	Streaming Medium 23 to 35 Mb/s
Streaming Low 3 to 4.5 Mb/s	Streaming Low 13 to 20 Mb/s

H.265	
HD	4K
Streaming High 2.3 to 4.5 Mb/s	Streaming High 22.5 to 30 Mb/s
Streaming Medium 1.5 to 3 Mb/s	Streaming Medium 14 to 20 Mb/s
Streaming Low 0.8 to 2 Mb/s	Streaming Low 8 to 10 Mb/s

Die für die Qualitätseinstellung verwendete Datendurchsatzrate richtet sich nach der Videonorm, in der Ihr Web Presenter betrieben wird. Beispiel: Wenn Sie fürs Streamen die hohe Qualitätsstufe „HyperDeck High“ wählen und in 1080p/24 arbeiten, wird die Datenrate 6 Mb/s verwendet.

Wie Sie der Tabelle entnehmen können, sind die Streaming-Datenraten vergleichsweise niedriger als die HyperDeck-Datenraten. Dies ermöglicht die Übertragung von Daten übers Internet, wofür in der Regel eine geringere Bandbreite benötigt wird als für die Aufzeichnung von Daten auf eine Festplatte.

Sie werden bemerken, dass es zwei Datenraten pro Einstellung gibt. Die niedrigere Rate wird für die niedrigeren Frameraten 24p, 25p und 30p verwendet. Die höhere Datenrate wird für die höheren Frameraten 50p und 60p verwendet. Wichtig: Die Standardeinstellung für die Streaming-Qualität ist „Streaming Hoch 6–9 Mb/s“. Sie bietet einen sehr hochwertigen Streaming-Kanal.

Die Buttons ON und ON AIR

Mit den Buttons ON und ON AIR starten oder stoppen Sie einen Livestream. Der ON-AIR-Button leuchtet rot, solange ein Livestream im Gange ist.

Löschen von importierten Einstellungen

Um alle importierten Streaming-Einstellungen aus Ihrem Web Presenter zu löschen, klicken Sie auf das Zahnradsymbol unten links auf dem Tab „Live Stream“. Klicken Sie auf „Remove“, um Ihre Auswahl zu bestätigen.

„Audio“-Tab

Der Tab „Audio“ enthält Optionen zum Konfigurieren der Audioüberwachungsausgabe und der Audiometer Ihres Web Presenters.

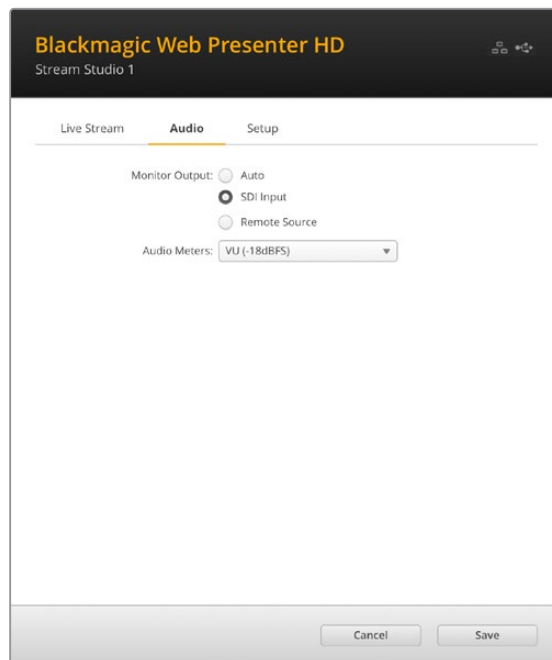

Monitor Output

Verwenden Sie die Monitorausgabe-Optionen, um die Audioquelle auszuwählen, die für die SDI- und HDMI-Monitorausgaben Ihres Web Presenters verwendet wird.

Auto

Wenn die Monitorausgabe auf „Auto“ eingestellt ist, erkennt und überhört Ihr Web Presenter automatisch Talkback-Audio, das von einem ATEM Mischer über eine ATEM Streaming Bridge gesendet wird. Wird kein Talkback erkannt, wird der Ton vom SDI-Eingang verwendet.

SDI-Eingabe

Wählen Sie „SDI Input“, um den Ton von der SDI-Eingangsquelle Ihres Web Presenters mitzuverfolgen, zum Beispiel von einer angeschlossenen Blackmagic Studio Camera.

Remote Source

Mit dieser Option können Sie Talkback-Audio mithören, das von einem entfernten ATEM Mischer oder einer ATEM Streaming Bridge gesendet wird.

Audio Meters

Wählen Sie im „Audio Meters“-Menü den gewünschten Audiometertyp aus. Die verfügbaren Optionen sind VU -18dBFS, VU -20dBFS, PPM -18dBFS und PPM -20dBFS Referenzpegel.

Der Reiter „Setup“

The screenshot shows the 'Setup' tab of the Blackmagic Web Presenter HD interface. The title bar reads 'Blackmagic Web Presenter HD' and 'Stream Studio 1'. The interface has three tabs: 'Live Stream', 'Audio', and 'Setup'. The 'Setup' tab is selected. Under the 'Setup' tab, there are three input fields: 'Name' (Stream Studio 1), 'Language' (English), and 'Software' (Version 3.3). Below these is a 'Network' section with a refresh icon. It includes radio buttons for 'Protocol' (DCHP and Static IP, with Static IP selected), 'IP Address' (192.168.24.100), 'Subnet Mask' (255.255.255.0), 'Gateway' (192.168.24.1), 'Primary DNS' (8.8.8.8), and 'Secondary DNS' (8.8.4.4). There are also radio buttons for 'Connection Priority' (Ethernet and Mobile, with Mobile selected). At the bottom of the 'Setup' section is a 'Reset' section with a 'Factory Reset' button. At the very bottom of the interface are 'Cancel' and 'Save' buttons.

Name

Um Ihren Web Presenter umzubenennen, geben Sie den Namen in dieses Feld ein und klicken auf „Save“.

Language

Hierüber ändern Sie die Spracheinstellung des Geräts.

Software

Zeigt die aktuelle Softwareversion des Web Presenters an.

Network

Über diese Optionen konfigurieren Sie die Netzwerkeinstellungen. Hier geben Sie bspw. vor, ob das Gerät über DHCP oder eine statische IP-Adresse mit einem Netzwerk verbunden wird. Näheres zum Einrichten der Netzwerkeinstellungen für Ihren Web Presenter finden Sie im Abschnitt „Einbinden in ein Netzwerk“.

Connection Priority

Wenn sowohl eine Ethernet- als auch eine Mobilfunkverbindung mit dem Web Presenter bestehen, geben Sie über diese Einstellung vor, welche Verbindung zum Streamen verwendet werden soll. Näheres zum Tethering per Handy wird unter „Streaming mithilfe Ihres Smartphones“ erklärt.

Reset

Setzen Sie Ihren Web Presenter per Klick auf „Factory Reset“ zurück.

Netzwerkeinstellungen

Sie können Ihren Web Presenter entweder über eine statische IP-Adresse oder per DHCP in ein Netzwerk einbinden.

DHCP

Diese Einstellung weist Ihrem Gerät automatisch eine IP-Adresse zu und verbindet es mit Ihrem Netzwerk, ohne jegliche Einstellungen zu ändern.

Das Dynamic Host Configuration Protocol, kurz DHCP, ist ein auf Netzwerkservern und Internetroutern verwendeter Dienst, der Ihren Web Presenter automatisch findet und ihm eine IP-Adresse zuweist. DHCP erleichtert die Einbindung von Geräten per Ethernet und sorgt dafür, dass deren IP-Adressen nicht miteinander in Konflikt geraten. Die meisten Computer und Netzwerk-Switches unterstützen DHCP.

Static IP

Wenn Sie Ihrem Gerät selbst eine bestimmte IP-Adresse zuweisen möchten, wählen Sie einfach „Static IP“ (Statische ID) aus und ändern Sie die Einstellungen manuell.

Eine statische IP-Adresse ist eine feste IP-Adresse, die sich selbst beim Neustart Ihres Web Presenters nicht ändert.

Eine statische IP-Adresse mag dann erforderlich sein, wenn Sie Ihren Web Presenter in ein Firmennetzwerk einbinden. Gibt es in Ihrem Unternehmen einen Netzwerk-Administrator, werden in Ihrem Netzwerk möglicherweise individuelle IP-Adressen für sämtliche verbundene Geräte verwendet. Erkundigen Sie sich beim Netzwerk-Administrator, der Ihre Computer und das Firmennetzwerk verwaltet.

Internetfreigabe fürs Direktstreaming

Sollten Sie den Web Presenter nicht direkt mit einem Netzwerk-Switch oder Internetrouter verbinden können, geben Sie die Internetverbindung Ihres Computers über den Ethernet-Port für Ihren Web Presenter frei.

So richten Sie Ihren Blackmagic Web Presenter fürs Direktstreaming ein:

- 1 Stellen Sie Ihren Web Presenter auf DHCP ein.
- 2 Konfigurieren Sie Ihren Computer so, dass die Internetverbindung über Ethernet freigegeben ist.

Mac: Klicken Sie in den Systemeinstellungen auf „Freigaben“ und dann in der Liste der Dienste auf „Internetfreigabe“. Ist Ihr Mac über WLAN mit dem Internet verbunden, wählen Sie aus dem Drop-down-Menü „Verbindung teilen:“ die Option „WLAN“. Setzen Sie in der Liste „Mit Computern über:“ einen Haken bei „Ethernet“ und einen weiteren in der Liste der Dienste bei „Internetfreigabe“. Wenn Sie gefragt werden, ob Sie die Internetfreigabe wirklich aktivieren möchten, klicken Sie auf „Start“.

Windows: Führen Sie einen Rechtsklick auf dem Startsymbol aus und klicken Sie auf „Netzwerkverbindungen“. Es erscheint der Bildschirm zum Netzwerkstatus. Klicken Sie auf „Adapteroptionen ändern“. Dort sind alle Netzwerkverbindungen Ihres Computers aufgelistet. Führen Sie einen Rechtsklick auf der Internetverbindung aus und klicken Sie auf „Eigenschaften“. Erlauben Sie anderen Benutzern im Netzwerk unter „Netzwerk- und Freigabecenter“, die Internetverbindung dieses Computers zu nutzen. Wählen Sie im Menü eine Netzwerkverbindung aus und klicken Sie auf „OK“.

- 3 Verbinden Sie Ihren Web Presenter mit dem Ethernet-Port Ihres Computers. Nach wenigen Sekunden weist das DHCP dem Web Presenter eine IP-Adresse zu.
- 4 Stellen Sie sicher, dass Ihr Web Presenter per Ethernet mit dem Internet verbunden ist, indem Sie das Ethernet-Symbol oben rechts auf dem LCD des Geräts beobachten.

Streaming mithilfe Ihres Smartphones

Der Blackmagic Web Presenter unterstützt Streaming per Tethering über Ihr Smartphone. Sie können so von jedem beliebigen Ort auf der Welt streamen, solange Sie eine Mobilfunkverbindung haben.

So richten Sie mobiles Tethering ein:

- 1 Verbinden Sie Ihr Smartphone mithilfe eines USB-C-Kabels mit Ihrem Blackmagic Web Presenter. Dafür können Sie entweder den vorder- oder den rückseitigen USB-C-Verbinder benutzen.
- 2 Aktivieren Sie den Internet-Hotspot auf Ihrem Smartphone.

Gehen Sie auf iOS-Geräten zu „Einstellungen“ > „Persönlicher Hotspot“, um sicherzustellen, dass die Option „Zugriff für andere erlauben“ aktiviert ist. Wischen Sie auf Android-Geräten vom oberen Bildschirmrand nach unten, um ins Quick-Menü zu gelangen. Tippen Sie auf das Hotspot-Icon und halten Sie es gedrückt, um dann USB-Tethering zu aktivieren.

Nun können Sie an Ihrem Blackmagic Web Presenter die ON-AIR-Taste drücken, um auf Sendung zu gehen.

TIPP Um auf Ihrem Smartphone Akkulaufzeit zu sparen, empfehlen wir, die Tethering-Verbindung nach Beenden des Streams zu deaktivieren.

Ist ein Ethernet-Kabel mit Ihrem Web Presenter verbunden, werden Sie aufgefordert, zu bestätigen, dass es für mobiles Tethering der Internetverbindung konfiguriert ist. Öffnen Sie das Dienstprogramm Web Presenter Setup und gehen Sie zum Reiter „Setup“. Geben Sie als bevorzugte Verbindung unter „Network“ (Netzwerk) „Mobile“ (Mobilgerät) vor.

Verwenden des Blackmagic Web Presenter HD als Webcam

Softwares wie Skype oder Zoom sollten den Web Presenter automatisch als Webcam erkennen, sodass beim Start der Anwendung sofort das Video von Ihrem Web Presenter erscheint. Sollte die Anwendung den Web Presenter nicht automatisch auswählen, stellen Sie Webcam und Mikrofon manuell so ein, dass sie den Web Presenter verwenden.

Es folgt ein Beispiel zur Einrichtung der Webcam-Einstellungen in Skype.

- 1 Öffnen Sie in der Skype-Menüleiste unter Einstellungen „Audio und Video“.
- 2 Klicken Sie auf das Kamera-Drop-down-Menü und wählen Sie Ihren Web Presenter aus der Liste. Nun ist das Video aus dem Web Presenter im Vorschaufenster zu sehen.
- 3 Wählen Sie dann im Mikrofon-Drop-down-Menü Ihren Web Presenter als Audioquelle.

Einrichten von Open Broadcaster

Open Broadcaster ist eine quelloffene Anwendung, die als Streaming-Plattform zwischen Ihrem Web Presenter und Ihrer bevorzugten Streaming-Software fungiert. Das könnten bspw. YouTube, Twitch, Facebook Live oder andere sein. Open Broadcaster komprimiert Ihr Video auf eine Bitrate, die von Ihrer Streaming-Anwendung problemlos bewältigt wird.

Die folgende Demo zeigt, wie Sie Open Broadcaster zum Streamen der Webcam-Ausgabe Ihres Web Presenters mit YouTube Live als Streaming-Dienst einrichten.

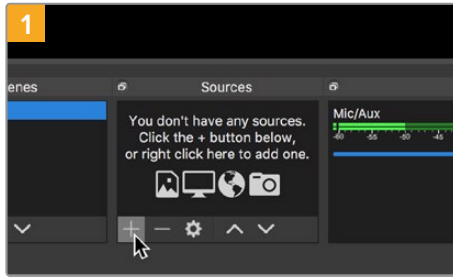

Öffnen Sie Open Broadcaster und klicken Sie auf das Pluszeichen unten im „Quellen“-Fenster.

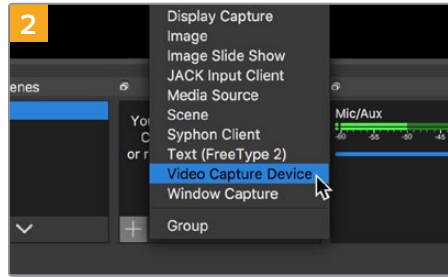

Wählen Sie „Videofassungsgerät“.

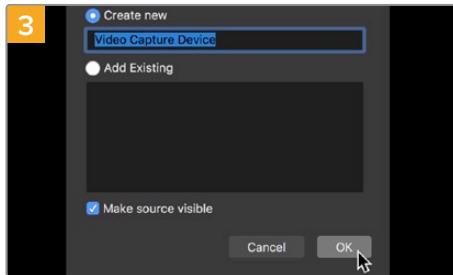

Benennen Sie die neue Quelle und klicken Sie auf „OK“.

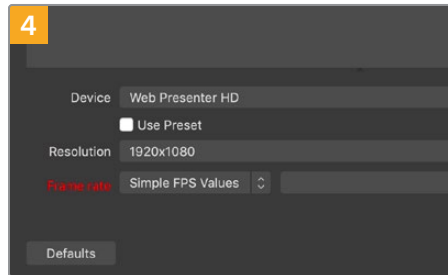

Wählen Sie im Geräte-Menü aus der Liste Ihr Web Presenter Modell und klicken Sie auf „OK“.

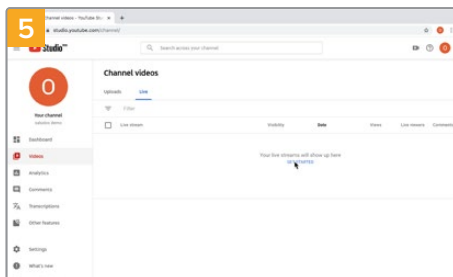

Gehen Sie jetzt zu Ihrem YouTube-Konto. Klicken Sie auf „Livestream starten“ und dann auf „Weiter“.

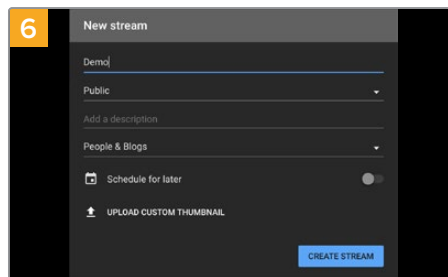

Geben Sie in den YouTube „Streamoptionen“ Ihre Sendedaten ein und klicken Sie auf „Stream erstellen“.

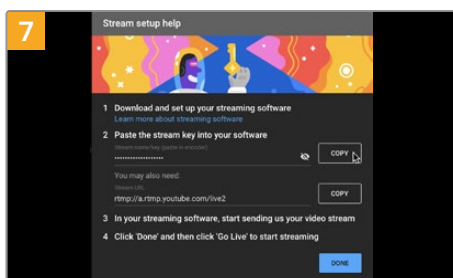

YouTube generiert nun einen Streamschlüssel bzw. -namen und leitet Open Broadcaster an Ihr YouTube-Konto weiter. Klicken Sie auf den „Kopieren“-Button neben dem Streamschlüssel, um ihn als Nächstes in Open Broadcaster einzufügen.

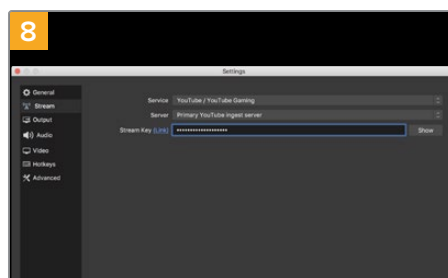

Gehen Sie zurück zu Open Broadcaster und öffnen Sie die Einstellungen, indem Sie in der Menüleiste auf „OBS/Einstellungen“ klicken. Wählen Sie „Stream“. Fügen Sie jetzt den aus YouTube kopierten Streamschlüssel ein und klicken Sie auf „OK“.

Nun ist das Video aus Ihrem Web Presenter im Streaming-Vorschauenfenster von Open Broadcaster zu sehen.

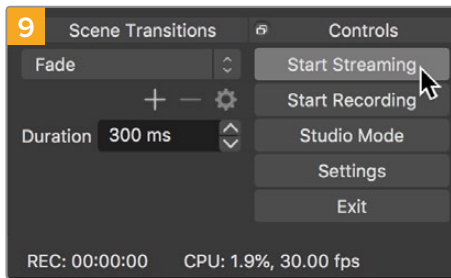

Um den Link in Open Broadcaster mit YouTube zu verknüpfen, klicken Sie unten rechts auf dem Bildschirm auf „Jetzt streamen“. Dies stellt die Verbindung von Open Broadcaster zu YouTube her. Von hier an richten Sie alles Weitere in YouTube Live ein.

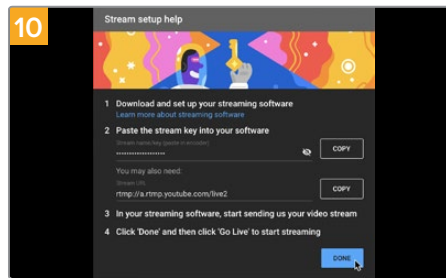

Zurück in YouTube Live ist die Webcam-Programmausgabe Ihres Web Presenters im Hintergrund zu sehen. Klicken Sie zur Bestätigung auf „Fertig“.

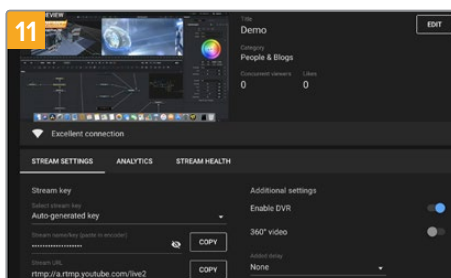

Open Broadcaster kommuniziert nun mit YouTube Live und alles ist startklar für die Übertragung Ihres Streams. Prüfen Sie sicherheitshalber alles noch einmal.

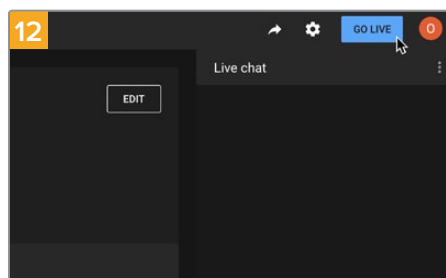

Wenn alles stimmt, beginnen Sie per Klick auf „Livestream starten“ mit der Ausstrahlung.

Jetzt strahlen Sie Ihre Sendung mit Open Broadcaster live auf YouTube aus.

HINWEIS Verzögerungen liegen in der Natur von Internetübertragungen. Verfolgen Sie den Stream also unbedingt auf YouTube, um sicherzugehen, dass Ihre Sendung zu Ende ist. Klicken Sie erst dann auf „Stream beenden“. Andernfalls riskieren Sie, Ihre Sendung frühzeitig abubrechen.

Videolinks mit einer ATEM Streaming Bridge

Mit einer ATEM Streaming Bridge können Sie Videostreams von jedem Web Presenter dekodieren und in SDI- oder HDMI-Video zurückwandeln. Dies ermöglicht es Ihnen, Video über Ihr lokales Netzwerk oder per Internet in alle Welt zu übertragen.

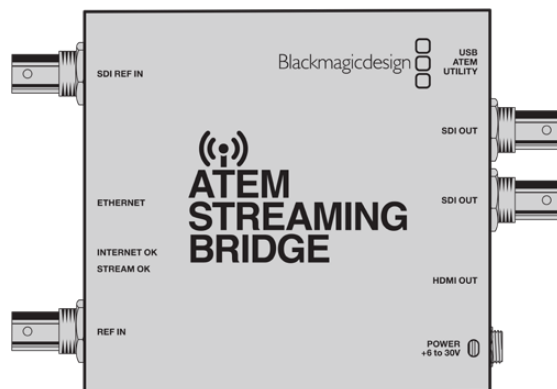

Wenn Ihre ATEM Streaming Bridge in dasselbe lokale Netzwerk wie Ihr Web Presenter eingebunden ist, wird sie in Web Presenter Setup auf dem Reiter „Live Stream“ im „Plattform“-Menü angezeigt.

Andernfalls können Sie eine XML-Datei mit den Streaming-Einstellungen von einem mit dem Web Presenter verbundenen USB-Laufwerk oder über die auf einem Computer installierte Anwendung Web Presenter Setup laden.

Ein gutes Beispiel für den Einsatz des Blackmagic Web Presenters mit einer ATEM Streaming ist die Übertragung des Wetterberichts von einem externen Standort an ein Studio. Alles, was Sie zur Übertragung von einem externen Standort benötigen, sind ein Web Presenter und eine Internetverbindung. Die Internetverbindung kann über ein Smartphone oder ein Netzwerk hergestellt werden.

Die ATEM Streaming Bridge im Studio nimmt diesen Internet-Feed und wandelt ihn in SDI, damit der Hauptstudiomischer ihn verarbeiten kann.

Das Setup für diesen Workflow könnte wie folgt aussehen:

- 1 Am Drehort wird der Blackmagic Web Presenter an den SDI-Programmausgang des Mixers angeschlossen, zum Beispiel einen ATEM Constellation 8K.
- 2 Als Nächstes wird der Blackmagic Web Presenter mit einem Smartphone verbunden.
- 3 Die ATEM Streaming Bridge im Studio wird ebenfalls per Ethernet mit dem Internet verbunden.
- 4 Die ATEM Streaming Bridge sendet den in SDI-Video gewandelten Internet-Feed für die Hauptübertragung der Nachrichten an den SDI-Eingang des Studiomischers.

Um die ATEM Streaming Bridge im Studio mit dem Internet-Feed des Web Presenters zu verbinden, starten Sie das Dienstprogramm ATEM Setup und konfigurieren Sie damit Ihre Internet-Einstellungen. Generieren Sie eine XML-Datei mit allen Streaming-Einstellungen und laden Sie diese auf den Web Presenter am Drehort.

Erstellen der XML-Datei

Um eine XML-Datei mit den Einstellungen zu erstellen, verbinden Sie die ATEM Streaming Bridge mit dem Internet, indem Sie ein Netzkabel vom Ethernet-Port zu einem Router oder Netzwerk-Switch anschließen.

Schließen Sie die ATEM Streaming Bridge über ein USB-C-Kabel an Ihren Computer an und starten Sie ATEM Setup.

Bestätigen Sie die korrekten Netzwerkeinstellungen auf dem Setup-Tab und wählen Sie unter „Stream Service“ die Option „Internet“. Es dürfte die Meldung „Visible worldwide“ (Weltweit sichtbar) im Feld „Internetstatus“ erscheinen. Das bedeutet, dass alles anständig funktioniert.

Ein Hinweis zur Portweiterleitung

Wenn Ihnen im Feld „Internetstatus“ ein Portweiterleitungs- oder UPnP-Fehler angezeigt wird, sollten Sie Ihren Internetanbieter oder Netzwerkadministrator bitten, die Portweiterleitung für Ihre Internetverbindung auf „TCP-Port 1935“ einzustellen.

Exportieren der XML-Datei

Nachdem Sie Ihre Einstellungen auf dem ATEM Setup-Tab bestätigt und erfolgreich eine Verbindung von Ihrer ATEM Streaming Bridge mit Ihrem Netzwerk oder dem Internet hergestellt haben, können Sie die XML-Setup-Datei exportieren.

- 1 Gehen Sie zum „External ATEM Mini Pro“-Tab oben rechts im Fenster.

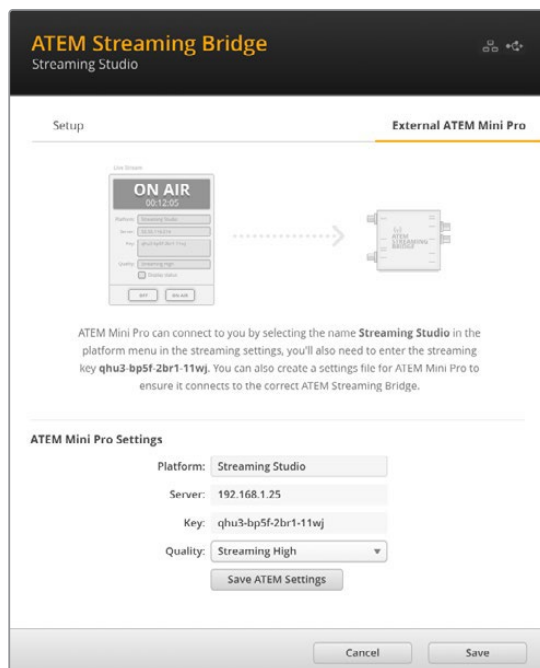

- 2 Um die Plattform individuell zu benennen, klicken Sie auf „Platform“ und geben einen neuen Namen ein. Der gleiche Name wird auch unter „Platform“ auf dem Blackmagic Remote-Gerät angezeigt.
- 3 Geben Sie die gewünschte Streaming-Qualität vor. Diese Einstellung gibt die Qualität für den remote eingesetzten Web Presenter vor.
- 4 Um die XML-Datei zu speichern, klicken Sie auf „Save ATEM Settings“. Wählen Sie einen Speicherort auf Ihrem Computer und klicken Sie auf „Save“.
- 5 Nun können Sie die gespeicherte XML-Datei an den Remote-Operator schicken.

TIPP In den Talkback-Einstellungen in ATEM Setup wählen Sie die Audiokanäle, die an den remote eingesetzten Web Presenter zurückgeschickt werden sollen.

Laden der XML-Datei

Nachdem die Einstellungsdatei per E-Mail an den externen Standort verschickt wurde, kann die Location-Crew die XML-Datei einfach mithilfe von Blackmagic Web Presenter Setup auf den Web Presenter laden. Dann muss nur noch jemand die ON-AIR-Taste drücken, um mit dem Streaming des Wetterberichts ans Studio zu beginnen.

Nach Laden der XML-Streaming-Datei können Sie den Stream beliebig starten und stoppen, ohne die Datei erneut laden zu müssen. So ist es ein Leichtes, einen ständigen Videolink zwischen dem Web Presenter und der ATEM Streaming Bridge herzustellen.

Solange die Streaming- und Netzwerkeinstellungen der ATEM Streaming Bridge im Studio nicht geändert werden und der Web Presenter sie nach wie vor sucht, wird der Web Presenter die Brücke immer im Internet finden. Sie können Ihren Web Presenter an jedem beliebigen Ort mit dem Internet verbinden. Wenn Sie dann die ON-AIR-Taste drücken, streamt der Web Presenter umgehend an die ATEM Streaming Bridge im Studio.

Weitere Infos zur Verwendung der ATEM Streaming Bridge finden Sie im ATEM Mini Handbuch. Dies steht zum Download unter www.blackmagicdesign.com/de/support bereit.

Tally, Talkback und Kamerasteuerung

Die ATEM Streaming Bridge und der Blackmagic Web Presenter unterstützen die Übermittlung von Tally-, Talkback- und Kamerasteuerungsdaten mit ATEM Mischern. Demnach sind Tally, Talkback und Kamerasteuerung für jede SDI-basierte Blackmagic Design Kamera an einem beliebigen Standort in Ihrem lokalen Netzwerk oder per Internet an einem beliebigen Ort in der Welt möglich.

Das ist ganz einfach eingerichtet. Die nachstehende Abbildung zeigt, wie Sie eine URSA Mini Pro 4.6K mitsamt Tally-, Talkback- und Kamerasteuersignalen über ein lokales Netzwerk mit einem ATEM Constellation 8K verbinden.

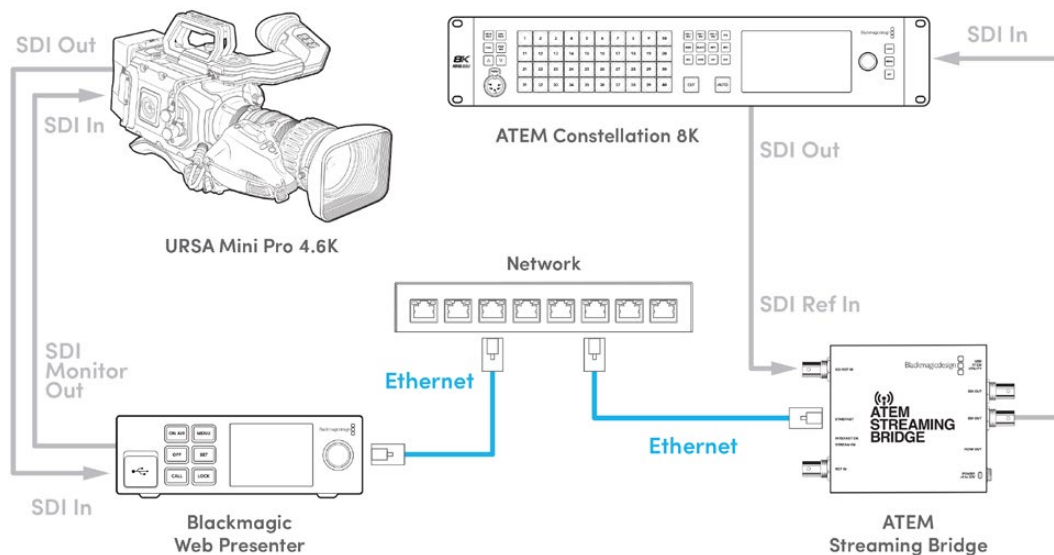

Wenn alles verbunden ist:

- 1 Drücken Sie die MENU-Taste am Blackmagic Web Presenter, um das LCD-Menü zu öffnen und zum „Livestream“-Menü zu navigieren.
- 2 Wählen Sie unter „Plattform“ die ATEM Streaming Bridge.
- 3 Bestätigen Sie Ihre Auswahl mit der SET-Taste.

Damit das Tally funktioniert, sollten Sie sichergehen, dass die ATEM Kamera-ID dem entsprechenden Eingang am Mischer entspricht. Weitere Informationen, wie Sie die ATEM Kamera-ID einrichten, finden Sie in der Bedienungsanleitung der URSA Mini.

Sie können das Tally testen, indem Sie die Kamera auf die Programmausgabe des ATEM Mixers umschalten. Ist die ATEM Kamera-ID auf Ihrer Kamera richtig eingestellt, leuchten das Tally-Licht und die Tally-Umrandung um das LCD der Kamera. Wenn Sie die Kamera nun auf Vorschauausgabe schalten, leuchtet das Tally grün.

Um die Kamerasteuerung zu testen, versuchen Sie, Blende und Schwarzabhebung über die Kamera-Seite in ATEM Software Control anzupassen.

Die Audiokanäle 15 und 16 für eingebettetes SDI dienen standardmäßig für Talkback. Im Dienstprogramm ATEM Setup können Sie Talkback jedoch auch auf die Techniker-Kanäle 13 und 14 oder die Programmausgabe einstellen.

Für Übertragungen über das Internet wird mit dem Dienstprogramm ATEM Setup eine XML-Setup-Datei erstellt. Diese XML-Datei wird dann auf den Blackmagic Web Presenter geladen, damit das Gerät die ATEM Streaming Bridge im Internet findet. Weitere Informationen zum Erstellen und Laden der XML-Setupdatei finden Sie im vorigen Abschnitt dieses Handbuchs.

Verbinden mit der URSA Broadcast G2

Die URSA Broadcast G2 hat eine eingebaute Streamingengine. Sie benötigen also keinen Blackmagic Web Presenter, da die Kamera direkt über den USB-C-Expansionsport streamen kann. Näheres, u. a. zum Einrichten der ATEM Kamera-ID für die Tally-Steuerung, finden Sie in der Bedienungsanleitung der URSA Broadcast G2.

Blackmagic Universal Rack Shelf

Die Blackmagic Universal Rack Shelf ist eine 1-HE-Rackwanne zum Einbau einer großen Auswahl an Blackmagic Design Geräten in ein Broadcast-Rack oder Flightcase. Dank des modularen Designs können Sie portable und praktische Setups mit Ihren Geräten erstellen, indem Sie Produkte mit einem Formfaktor verwenden, die nebeneinander in eine einzelne Rackeinheit passen.

Die folgende Abbildung zeigt 3 Universal Rack Shelves, die jeweils in einem kleinen Rack installiert und mit unterschiedlich kombinierten, kompatiblen Geräten bestückt sind. Das untere Regal enthält eine Blindplatte mit 1/3-Rackbreite, um ungenutzten Raum zwischen den Geräten zu füllen.

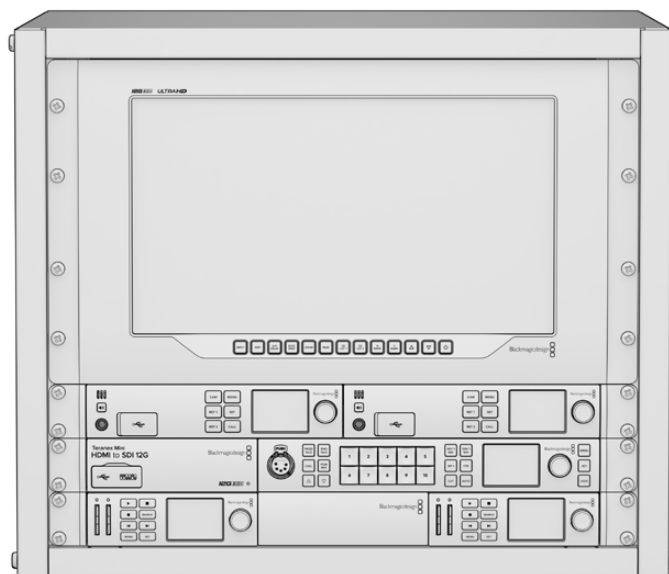

Inhalt

Das Universal Rack Shelf Kit enthält Folgendes:



1 Blackmagic Universal Rack Shelf

Ein Regal mit einer Rackeinheit in voller Breite für die Installation von Blackmagic Design Geräten.

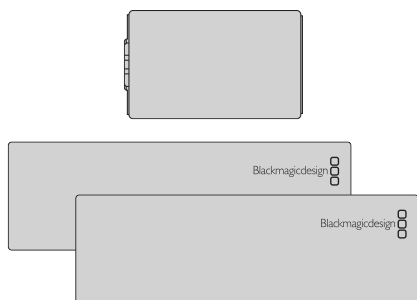

Blindplatten

1 x 1/6 Rackbreite und 2 x 1/3 Rackbreite Blindplatten, um ungenutzten Raum zwischen den Einheiten zu füllen.

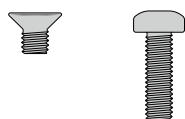

Schrauben

12 x 5mm-M3-
Senkkopfschrauben

2 x 9mm-M3-
Flachkopfschrauben für
1/6-Blindplatten

Montage von Geräten in das Rack

- 1 Entfernen Sie an einem Gerät mit Gummifüßen erst die Füße von seiner Unterseite mit einem Schabwerkzeug mit Kunststoffkanten.
- 2 Legen Sie die Rackwanne und das Gerät mit der Rückseite nach oben ab. Richten Sie dann die vorgebohrten Löcher am Rack auf die Montagepunkte an der Unterseite des Blackmagic Design Geräts aus. Es gibt zwei zentrale Montagepunkte an 1/3 breiten Einheiten sowie bis zu 3 zentrale Montagepunkte bei größeren Einheiten mit 1/2 Rackbreite.

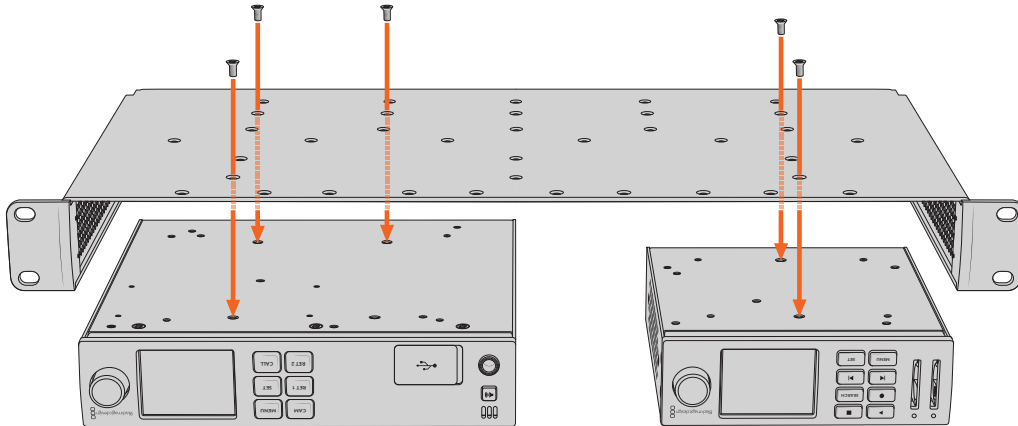

- 3 Befestigen Sie das Gerät mithilfe der mitgelieferten 5mm-M3-Senkkopfschrauben im Rack.
- 4 Drehen Sie die Rackwanne mit dem befestigten Gerät richtig herum und installieren Sie sie anhand der integrierten Rackohren in das Rack.

Mit den mitgelieferten Blindplatten können ungenutzte Regalflächen abgedeckt werden.

So bringen Sie eine 1/6-Blindplatte an:

Die kleine 1/6-Blindplatte kann verwendet werden, um ungenutzten Regalraum bei der Montage von Einheiten mit 1/2- und 1/3-Rackbreite zu füllen. Die Platte kann an den Seiten beider Geräte befestigt werden. Montieren Sie die Platte vorzugsweise zwischen den Geräten, um die Luftströmung sicherzustellen.

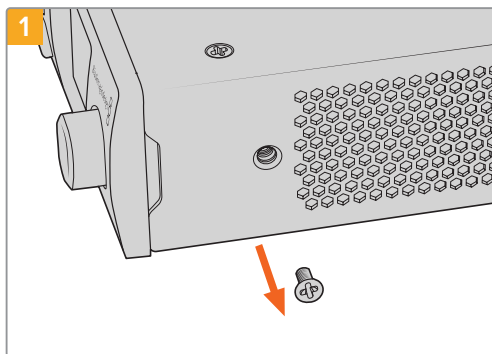

Entfernen Sie die 5mm-M3-Schraube nahe der Frontblende

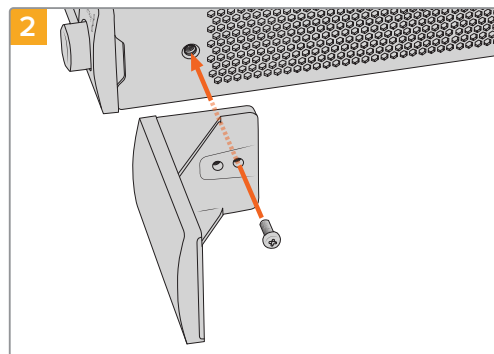

Richten Sie die Blindplatte aus und befestigen Sie sie mit der mitgelieferten 9mm-M3-Nylonschraube

So bringen Sie eine 1/3-Blindplatte an der Seite an:

Die großen 1/3 breiten Blindplatten lassen sich bei der Montage einzelner Geräte direkt an beiden Seiten der Rackwanne anbringen. Um eine Blindplatte zu installieren, richten Sie die Schraubenlöcher und den Ankerpunkt an der Unterseite der Platte mit dem Regal aus. Befestigen Sie sie mit zwei der mitgelieferten 5mm-M3-Senkkopfschrauben.

Aktualisieren der Produktsoftware

Anhand des Setup-Dienstprogramms können Sie die Produktsoftware Ihres Web Presenters aktualisieren. Des Weiteren dient es zur Konfiguration der Streaming- und Netzwerkeinstellungen sowie der Streaming-Qualität.

So aktualisieren Sie die Produktsoftware:

- 1 Laden Sie das neueste Installationsprogramm für den Blackmagic Web Presenter unter www.blackmagicdesign.com/de/support herunter.
- 2 Führen Sie das Blackmagic Web Presenter Installationsprogramm aus und folgen Sie den Anweisungen auf dem Bildschirm.
- 3 Verbinden Sie Ihren Web Presenter nach abgeschlossener Installation über den USB-Port an der Rückseite oder den mit einer Plastikcappe abgedeckten USB-Port an der Frontblende mit dem Computer.
- 4 Starten Sie Blackmagic Web Presenter Setup und folgen Sie den Bildschirmanweisungen, um die Produktsoftware zu aktualisieren. Erscheint keine Aufforderung, so ist Ihre Produktsoftware auf dem neuesten Stand und Sie brauchen nichts weiter zu tun.

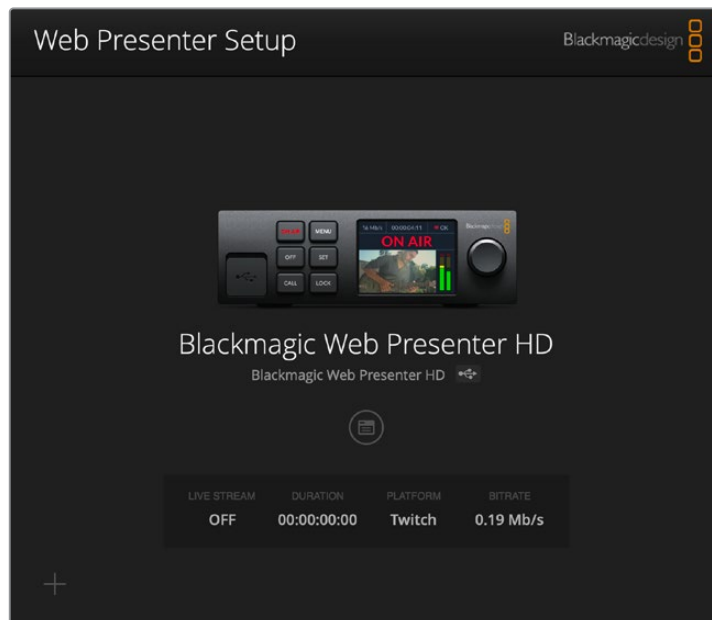

Die neueste Version des Setup-Dienstprogramms für Ihren Blackmagic Web Presenter erhalten Sie im Blackmagic Design Support-Center unter www.blackmagicdesign.com/de/support

Informationen für Entwickler (Englisch)

Blackmagic Web Presenter Ethernet Protocol

v1.2

Protocol Details

Overview

The Blackmagic Web Presenter Ethernet Protocol is a line-oriented, text-based protocol to control a Web Presenter.

Lines from the Web Presenter server will be separated by an ASCII LF sequence.

Messages from the user may be separated by LF or CR LF.

Connection

The Web Presenter server is accessed by connecting to TCP port 9977 on a Web Presenter.

Connection Response

Upon connection, the Web Presenter server sends a dump of the device's state.

The Web Presenter server sends information in blocks, with each having an identifying header followed by a colon. A block spans multiple lines and is terminated by a blank line. Each line in the protocol is terminated by a newline character.

Following the header, a block contains either a single multi-line string or a sequence of key/value pairs arranged one per line. The first full-colon on a line is used to delimit the key and the value. A value may be a comma separated list. In this case, values in the list must have the “,” and “\” characters escaped with a “\” character.

To be resilient to future protocol changes, clients should ignore blocks they do not recognize, up to the trailing blank line. Within recognized blocks, clients should ignore keys they do not recognize.

Legend	
↵	End of line
...	and so on
Orange Text	Client Generated
Grey Text	Server Generated

The protocol preamble block is always the first block sent by the Web Presenter server:

```
PROTOCOL PREAMBLE:↵
Version: 1.2↵
↵
```

The version field indicates the protocol version. When the protocol is changed in a compatible way, the minor version number will be updated. If incompatible changes are made, the major version number will be updated.

The initial status dump is concluded by the end prelude block:

```
END PRELUDE:↵
↵
```

Status Updates

When any device parameter is changed on the Web Presenter server by any client, such as the Blackmagic Web Presenter Setup utility, the Web Presenter server resends the applicable status block, containing only the items that have changed. Status updates can also occur due to external changes such as tethering to a smartphone or when a streaming service is disconnected.

For example, if the input video mode is set to Auto, the following block will be sent:

```
STREAM SETTINGS:↵  
Video Mode: Auto↵  
↵
```

Requesting Changes

To change one or more parameters in a block, the client should send the appropriate block header in the same form the Web Presenter server sends, followed by the key/value pairs to be changed. For example, to change the input video format to 1080p59.94, the user should send the following block:

```
STREAM SETTINGS:↵  
Video Mode: 1080p59.94↵  
↵
```

The block must be terminated by a blank line. On receipt of a blank line, the Web Presenter server will either acknowledge the request by responding:

```
ACK↵  
↵
```

or if unable to parse the block responding with:

```
NACK↵  
↵
```

After a positive response, the client should expect to see a status update from the Web Presenter server showing the status change. This is likely to be the same as the command that was sent, sometimes followed by other blocks providing data specific to the change.

```
STREAM SETTINGS:↵  
Video Mode: 1080p59.94↵  
↵
```

If the Web Presenter server does not understand a key in the requested block, the key will be ignored. If an invalid value is provided for a known key, then the request is ignored and the Web Presenter will respond with the existing value for the key. In both cases the Web Presenter server will still respond with an ACK.

```
STREAM SETTINGS:↵  
Video Mode: UnsupportedMode↵  
↵  
ACK↵  
↵  
STREAM SETTINGS:↵  
Video Mode: 1080p59.94↵  
↵
```

Requesting a Status Dump

The user may request that the Web Presenter server resend the complete state of any status block by sending the block header, followed by a blank line. In the following example, the user requests the Web Presenter server resend the stream settings:

```
STREAM SETTINGS:↵
↵
ACK↵
↵
STREAM SETTINGS:↵
Video Mode: 1080p59.94↵
...
↵
```

Protocol Blocks

Identity Block

The identity block contains information to identify the connected Web Presenter.

Block Syntax

The following example shows the Identity Block for a Blackmagic Web Presenter HD.

```
IDENTITY:↵
Model: Blackmagic Web Presenter HD↵
Label: Blackmagic Web Presenter HD↵
Unique ID: 00112233445566778899AABBCCDDEEFF↵
↵
```

Parameters

Key	Read/Write	Description	Valid Values
Model	Read only	The Web Presenter model name	String
Label	Read/Write	A display name for the Web Presenter	String
Unique ID	Read only	A device specific unique identifier	Hexadecimal ID

Changing Device Label

A device label to identify the Web Presenter can be changed by sending an identity block with label key.

```
IDENTITY:↵
Label: My Web Presenter↵
↵
ACK↵
↵
IDENTITY:↵
Label: My Web Presenter↵
↵
```

Version Block

The version block contains hardware and software version information for the connected Web Presenter.

Block Syntax

```
VERSION:↵  
Product ID: BE73↵  
Hardware Version: 0100↵  
Software Version: 0123ABCD↵  
Software Release: 3.3↵  
↵
```

Parameters

Key	Read/Write	Description	Valid Values
Product ID	Read only	The Web Presenter product ID	Hexadecimal ID
Hardware Version	Read only	The Web Presenter hardware version	Hexadecimal version
Software Version	Read only	The Web Presenter software version	Hexadecimal version
Software Release	Read only	The Web Presenter software release version	Version Number

Network Blocks

The network block contains the TCP/IP networking configuration for the connected Web Presenter.

Block Syntax

This example shows the output for a connected Web Presenter. It displays 2 networking interfaces - the Gigabit Ethernet interface and option for a tethered smartphone.

The network settings prefixed with Current show the active TCP/IP settings, and are read-only. The Current settings reflect either the DHCP or Static configuration, depending on the Dynamic IP flag.

```
NETWORK:↵  
Interface Count: 2↵  
Default Interface: 0↵  
↵  
NETWORK INTERFACE 0:↵  
Name: Ethernet↵  
Priority: 1↵  
MAC Address: 00:11:22:33:44:55↵  
Dynamic IP: true↵  
Current Addresses: 192.168.1.10/255.255.255.0↵  
Current Gateway: 192.168.1.1↵  
Current DNS Servers: 192.168.1.1, 8.8.8.8, 8.8.4.4↵  
Static Addresses: 10.0.0.2/255.255.255.0↵  
Static Gateway: 10.0.0.1↵  
Static DNS Servers: 8.8.8.8, 8.8.4.4↵  
↵
```

```

NETWORK INTERFACE 1:↵
Name: USBEthernet↵
Priority: 0↵
MAC Address: 00:00:00:00:00:00↵
Dynamic IP: true↵
Current Addresses: 0.0.0.0/255.255.0.0↵
Current Gateway: 0.0.0.0↵
Current DNS Servers: ↵
Static Addresses: 10.0.0.2/255.255.255.0↵
Static Gateway: 10.0.0.1↵
Static DNS Servers: 8.8.8.8, 8.8.4.4↵
↵

```

Parameters

Network Block

Key	Read/Write	Description	Valid Values
Interface Count	Read only	The number of networking interfaces supported by the Web Presenter	Integer
Default Interface	Read only	The default networking interface	Integer

Network Interface Block

Key	Read/Write	Description	Valid Values
Name	Read only	The name of the networking interface	String
Priority	Read/Write	The priority of the network interface. When multiple network interfaces are available, the high priority interface will become the default	Unsigned integer. The higher number is the higher priority
MAC Address	Read Only	MAC address of the networking interface	IEEE 802 MAC address
Dynamic IP	Read/Write	Selects DHCP or Static IP configuration	true - DHCP enabled false - Static IP
Current Addresses	Read Only	The current IP address and Subnet mask	{IPv4 address}/{Subnet Mask}
Current Gateway	Read Only	The current IP gateway address	IPv4 address
Current DNS Servers	Read only	The IP addresses of the current DNS servers	Comma separated list of IPv4 addresses
Static Addresses	Read/Write	Status IP address and subnet mask when DHCP disabled	{IPv4 address}/{Subnet Mask}
Static Gateway	Read/Write	Static gateway address when DHCP disabled	IPv4 address
Static DNS Servers	Read/Write	The IP addresses of the static DNS servers	Comma separated list of IPv4 addresses

Changing Networking Settings

The network can be configured to use either DHCP or a static configuration. To enable DHCP on Network Interface 0:

```
NETWORK INTERFACE 0:↵
```

```
Dynamic IP: true↵
```

```
↵
```

```
ACK↵
```

```
↵
```

```
NETWORK INTERFACE 0:↵
```

```
Dynamic IP: true↵
```

```
↵
```

To set a fixed IP address, supply all static parameters:

```
NETWORK INTERFACE 0:↵
```

```
Dynamic IP: false↵
```

```
Static Addresses: 192.168.1.2/255.255.255.0↵
```

```
Static Gateway: 192.168.1.1↵
```

```
Static DNS Servers: 8.8.8.8, 8.8.4.4↵
```

```
↵
```

```
ACK↵
```

```
↵
```

```
NETWORK INTERFACE 0:↵
```

```
Dynamic IP: false↵
```

```
Static Addresses: 192.168.1.2/255.255.255.0↵
```

```
Static Gateway: 192.168.1.1↵
```

```
Static DNS Servers: 8.8.8.8, 8.8.4.4↵
```

```
↵
```

Changing network settings may cause the IP connection to be dropped.

UI Settings Block

The UI settings block contains the front panel LCD and monitor output settings for the connected Web Presenter.

Block Syntax

```
UI SETTINGS:↵
```

```
Available Locales: en_US.UTF-8, zh_CN.UTF-8, ja_JP.UTF-8, ko_KR.UTF-8, es_ES.UTF-8, de_DE.UTF-8, fr_FR.UTF-8, ru_RU.UTF-8, it_IT.UTF-8, pt_BR.UTF-8, tr_TR.UTF-8, pl_PL.UTF-8, uk_UA.UTF-8↵
```

```
Current Locale: en_US.UTF-8↵
```

```
Available Audio Meters: PPM -18dB, PPM -20dB, VU -18dB, VU -20dB↵
```

```
Current Audio Meter: PPM -20dB↵
```

```
↵
```

Parameters

Key	Read/Write	Description	Valid Values
Available Locales	Read only	The locales available in the Web Presenter	Comma separated list of locales
Current Locale	Read/Write	The current locale for Web Presenter	Refer to the locales from the Available Locales field
Available Audio Meters	Read only	The available audio meters supported by the Web Presenter	Comma separated list of audio meter types
Current Audio Meter	Read/Write	The current audio meter	Refer to the audio meters from the Available Audio Meters field

Stream Settings Block

The stream settings block contains the stream configuration for the connected Web Presenter.

Block syntax

This example shows the output for a connected Web Presenter. The stream settings prefixed with Current show the active stream settings and are writable. The stream settings prefixed by Available show the available stream settings for the device or platform and are read-only. To view the available servers or quality levels for a stream service, the Current Platform stream setting should be set first.

```
STREAM SETTINGS:↵
Available Video Modes: Auto, 1080p23.98, 1080p24, 1080p25, 1080p29.97,
1080p30, 1080p50, 1080p59.94, 1080p60, 720p25, 720p30, 720p50, 720p60↵
Video Mode: 1080p59.94↵
Current Platform: YouTube↵
Current Server: Primary↵
Current Quality Level: Streaming Medium↵
Stream Key: abc1-def2-ghi3-jkl4-mno5↵
Password: ↵
Current URL: srt://192.168.8.51
Customizable URL: true
Available Default Platforms: YouTube RTMP, YouTube SRT (Beta), Facebook,
Twitch, Twitter, Restream.IO, Vimeo, BoxCast, CastR, AfreecaTV, Bilibili,
DouYu, Weibo↵
Available Custom Platforms: My Platform↵
Available Servers: Primary, Secondary↵
Available Quality Levels: HyperDeck High, HyperDeck Medium, HyperDeck Low,
Streaming High, Streaming Medium, Streaming Low↵
↵
```

Parameters

Key	Read/Write	Description	Valid Values
Available Video Modes	Read only	The video modes available in the Web Presenter	Comma separated list of video modes
Video Mode	Read/Write	The current video mode	Refer to the video modes from the <i>Available Video Modes</i> field
Current Platform	Read/Write	The selected streaming platform	Refer to the platforms from the <i>Available Default Platforms</i> and <i>Available Custom Platforms</i> fields
Current Server	Read/Write	The current server for the streaming platform	Server is dependent on selected Current Platform
Current Quality Level	Read/Write	The current streaming quality level	Quality level is dependent on selected Current Platform
Stream Key	Read/Write	The stream key for the streaming platform	String
Password	Read/Write	The passphrase for an encrypted SRT stream	String
Current URL	Read/Write	The current URL for the streaming platform. This field is writable if <i>Customizable URL</i> field is true.	String
Customizable URL	Read only	A boolean specifying whether custom URLs are supported by the streaming platform	true - Custom URLs are supported false - Custom URLs are not supported
Available Default Platforms	Read only	The available default streaming platforms	Comma separated list of default platforms
Available Custom Platforms	Read only	The custom streaming platforms loaded in the Web Presenter	Comma separated list of custom platforms
Available Servers	Read only	The available servers for the selected streaming platform	Comma separated list of servers
Available Quality Levels	Read only	The available quality levels for the selected streaming platform	Comma separated list of quality levels

Changing Stream Settings

The stream settings can be changed by providing a stream settings block. The following is an example of streaming a 1080p59.94 input on Twitch with a medium stream quality.

```

STREAM SETTINGS:↵
Video Mode: 1080p59.94↵
Current Platform: Twitch↵
Current Server: US West: Los Angeles, CA↵
Current Quality Level: Streaming Medium↵
Stream Key: live_123456789_1aB2cD3eF4gH5iJ6kL7mN8oP9qR0sT↵
↵
ACK↵
↵
STREAM SETTINGS:↵
Video Mode: 1080p59.94↵
Current Platform: Twitch↵
Current Server: US West: Los Angeles, CA↵
Current Quality Level: Streaming Medium↵
Stream Key: live_123456789_1aB2cD3eF4gH5iJ6kL7mN8oP9qR0sT↵
↵

```

Stream XML Block

The stream XML block allows users to configure the Web Presenter with a custom configuration file in XML format.

Block syntax

The following example shows an XML file - Custom.xml has been loaded to configure the stream settings in the Web Presenter.

```
STREAM XML:↵  
Files: Custom.xml↵  
↵
```

Parameters

Key	Read/Write	Description	Valid Values
Files	Read/Write	The XML files loaded in Web Presenter	Comma separated list of filenames
Action	Write only	The stream XML action	Remove Remove All

Adding a Stream XML file

An XML file can be loaded onto a Web Presenter by sending the stream xml command with a filename, then provide the contents of the XML file. After adding the XML file, the Available Custom Platforms field in the STREAM SETTINGS block will be updated with the new platforms, however the Current items will remain unchanged.

For the Stream XML block to be parsed correctly, any blank lines should be removed from the XML files.

Refer to the `Blackmagic Stream XML File Format` section in this manual for description of the Stream XML file format.

```
STREAM XML Custom.xml:↵  
<?xml version="1.0" encoding="UTF-8"?>↵  
<streaming>↵  
  <service>↵  
    <name>My Custom Platform</name>↵  
    ...  
  </service>↵  
</streaming>↵  
↵  
ACK↵  
↵  
STREAM XML Custom.xml:↵  
<?xml version="1.0" encoding="UTF-8"?>↵  
<streaming>↵  
  <service>↵  
    <name>My Custom Platform</name>↵  
    ...  
  </service>↵  
</streaming>↵  
↵
```

```
STREAM XML:↵
Files: Custom.xml↵
↵
STREAM SETTINGS:↵
Available Custom Platforms: My Custom Platform↵
↵
```

Removing a Stream XML file

An XML file can be removed from the Web Presenter by sending the stream xml command with the remove action.

```
STREAM XML:↵
Action: Remove↵
Files: Custom.xml↵
↵
ACK↵
↵
STREAM XML:↵
Files:↵
↵
STREAM SETTINGS:↵
Available Custom Platforms:↵
↵
```

Removing all Stream XML files

All XML files can be removed from the Web Presenter by sending the stream xml command with the remove all action. In the example, following the remove all action, the loaded stream XML files and available custom platforms are both displayed as empty.

```
STREAM XML:↵
Action: Remove All↵
↵
ACK↵
↵
STREAM XML:↵
Files: ↵
↵
STREAM SETTINGS:↵
Available Custom Platforms:↵
↵
```

Stream State Block

The stream state block provides the streaming status of the Web Presenter.

The Web Presenter server will send a stream state block update whenever there is a change to the Status field. Due to frequency of changes to Duration, Bitrate and Cache Used fields, these fields need to be polled by the client by requesting a Stream State block.

Block syntax

```
STREAM STATE:↵↵
Status: Idle↵↵
Bitrate: 161672↵↵
Duration: 00:00:00:00↵↵
Cache Used: 0↵↵
↵↵
```

Parameters

Key	Read/Write	Description	Valid Values
Status	Read only	The stream state of the Web Presenter, updated when the stream status changes	Idle Connecting Streaming Interrupted
Action	Write only	The Web Presenter stream state action.	Start Stop
Duration	Read only	The duration of the active stream	String in format of DD:HH:MM:SS
Bitrate	Read only	The bitrate of the active stream	Integer bits per second
Cache Used	Read only	The current usage of the streaming cache	Integer as a percentage

Starting Stream

The stream is started by providing a stream state block with start action.

```
STREAM STATE:↵↵
Action: Start↵↵
↵↵
ACK↵↵
↵↵
STREAM STATE:↵↵
Status: Connecting↵↵
↵↵
STREAM STATE:↵↵
Status: Streaming↵↵
↵↵
```

Stopping stream

The stream is stopped by providing a Stream State block with stop action.

```
STREAM STATE:↵↵
Action: Stop↵
↵
ACK↵
↵
STREAM STATE:↵↵
Status: Idle↵
↵
```

Audio Settings Block

The Audio Settings block contains the audio configuration for the connected Web Presenter.

Block syntax

This example shows the output for a connected Web Presenter. The stream settings prefixed with Current show the active audio settings and are writable. The stream settings prefixed by Available show the available audio settings for the device or platform and are read-only.

```
AUDIO SETTINGS:↵↵
Current Monitor Out Audio Source: Auto↵
Available Monitor Out Audio Sources: Auto, SDI In, Remote Source↵
↵
```

Parameters

Key	Read/Write	Description	Valid Values
Current Monitor Out Audio Source	Read/Write	The current audio source on the monitor output	Refer to the audio sources from the <i>Available Monitor Out Audio Sources</i> field
Available Monitor Out Audio Sources	Read only	The available audio sources that can be routed to the monitor output	Comma separated list of audio sources

Changing Audio Settings

The audio settings can be changed by providing a audio settings block. The following is an example of setting the monitor output audio source to remote.

```
AUDIO SETTINGS:↵↵
Current Monitor Out Audio Source: Remote Source↵
↵
ACK↵
↵
AUDIO SETTINGS:↵↵
Current Monitor Out Audio Source: Remote Source↵
↵
```

Shutdown Block

The Shutdown block provides power control of the Web Presenter. The Shutdown block is write-only and not presented in the preamble.

Parameters

Key	Read/Write	Description	Valid Values
Action	Write only	The Web Presenter shutdown action.	Reboot Factory Reset

Reboot

The Web Presenter can be rebooted by providing a Shutdown block with reboot action.

```
SHUTDOWN:↵
```

```
Action: Reboot↵
```

```
↵
```

```
ACK↵
```

```
↵
```

On reboot action, the Web Presenter server will be stopped and clients will be disconnected.

Factory Reset

The Web Presenter can be factory reset by providing a Shutdown block with factory reset action. On factory reset action, all settings are set to factory defaults.

```
SHUTDOWN:↵
```

```
Action: Factory Reset↵
```

```
↵
```

```
ACK↵
```

```
↵
```

Blackmagic Streaming XML Format

Overview

The Blackmagic Streaming XML allows users to specify streaming services in addition to the default services provided by the Web Presenter.

The Streaming XML can be loaded into the Web Presenter with Web Presenter Setup. Refer to the 'Using Web Presenter Setup' section earlier in this manual

The Streaming XML can also be loaded by copying the contents into the Stream XML block with the Blackmagic Web Presenter Ethernet Protocol.

The following is a minimal example of a Streaming XML file:

```
<?xml version="1.0" encoding="UTF-8"?>
<streaming>
  <service>
    <name>My Streaming Service</name>
    <servers>
      <server>
        <name>My Streaming Server</name>
        <url>rtmp://my.streaming-server.com/live</url>
      </server>
    </servers>
    <profiles>
      <profile>
        <name>My Streaming Quality</name>
        <config resolution="1080p" fps="60" codec="H264">
          <bitrate>7500000</bitrate>
        </config>
      </profile>
    </profiles>
  </service>
</streaming>
```

Streaming XML Definition

The Streaming XML file follows standard XML format and shall begin with XML declaration.

```
<?xml version="1.0" encoding="UTF-8"?>
```

Streaming Element

The Streaming XML file shall be contained by the <streaming> element. The <streaming> element will consist of 1 or more <service> child elements.

The following is an example of a <streaming> element block that defines 2 streaming services.

```
<streaming>
  <service>
    <name>Service 1</name>
    <!-- Streaming settings for "Service 1" -->
  </service>
  <service>
    <name>Service 2</name>
    <!-- Streaming settings for "Service 2" -->
  </service>
</streaming>
```

Service Element

The <service> element provides a description of the streaming service. If multiple streaming services are used, it is possible to define multiple <service> elements within each <streaming> element block.

The following is an example of a <service> element block in the Stream XML file.

```
<streaming>
  <service customizable-url="true">
    <name>My Streaming Service</name>
    <key>abc1-def2-ghi3-jkl4-mno5</key>
    <servers>
      <!-- Streaming server settings -->
    </servers>
    <profiles default="Streaming High">
      <!-- Streaming quality settings-->
    </profiles>
    <credentials>
      <!-- Streaming username and password settings -->
    </credentials>
  </service>
  <!-- <service> elements blocks for other streaming services -->
</streaming>
```

Attributes

Attribute	Optional/Required	Description
customizable-url	Optional	The service supports specifying custom URLs - supported = "true" or unsupported = "false" (default)

Child Elements

Element	Optional/Required	Description
<name>	Required	The name of the streaming service
<key>	Optional	The stream key for the streaming service
<servers>	Optional	The RTMP/SRT server settings of the streaming service (see below). May be omitted if customizable-url is true.
<profiles>	Required	The quality settings of the streaming service (see below)
<credentials>	Optional	The username and password of the streaming service (see below)

Servers Element

The <servers> element consists of 1 or more <server> child elements for defining the streaming server(s). The <servers> element is a required child of the <service> element. Defining multiple servers allows specifying localized and/or backup servers within a single XML description

The following is an example of a <servers> element block that defines a primary and secondary URL for the SRT server.

```
<service>
  ...
  <servers>
    <server group="Primary">
      <name>My Streaming Service Server</name>
      <url>srt://srt.my-streaming-service.com:2010</url>
      <srt-extensions>
        ...
      </srt-extensions>
    </server>
    <server group="Secondary">
      <name>My Streaming Service Backup Server</name>
      <url>srt://srt-backup.my-streaming-service.com:2010</url>
      <srt-extensions>
        ...
      </srt-extensions>
    </server>
    <!-- Additional <server> element blocks defining other
servers for streaming service -->
  </servers>
  ...
</service>
```

Attributes

Attribute	Optional/Required	Description
group	Optional	The logical grouping for the server

Child Elements

Element	Optional/Required	Description
<name>	Required	The name of the RTMP/SRT streaming server
<url>	Required	The URL of the RTMP/SRT streaming server
<srt-extensions>	Optional	Extended service block specific to SRT streaming server (see below)

SRT Extensions Element

The <srt-extensions> element consists of 1 or more child elements that define SRT specific parameters.

The following is an example of a <srt-extensions> element block for a primary stream identifier.

```
<service>
  ...
  <servers>
    <server group="Primary">
      ...
      <srt-extensions>
        <stream-id>
          <item key="copy" value="0"/>
        </stream-id>
      </srt-extensions>
    </server>
  </servers>
  ...
</service>
```

Child Elements

Element	Optional/Required	Description
<stream-id>	Required	Provides element with custom parameters for the stream ID. Each child element of stream-id has 1 or more item elements with a key/value pair.

Profiles Element

The <profiles> element consists of 1 or more <profile> child elements that define streaming quality. The <profiles> element is a required child of the <service> element. Defining multiple profiles allows specifying custom bitrates for different streaming qualities.

The following is an example of a <profiles> element block that defines 3 profiles.

```
<service>
  ...
  <profiles default="Streaming High">
    <profile>
      <name>Streaming High</name>
      <!-- Define <config> elements to specify target
bitrates for Streaming High profile -->
    </profile>
    <profile>
      <name>Streaming Medium</name>
      <!-- Define <config> elements to specify target
bitrates for Streaming Medium profile -->
    </profile>
  </profiles>
  ...
</service>
```

Attributes

Attribute	Optional/Required	Description
default	Optional	The name of the default profile

Child Elements

Element	Optional/Required	Description
<name>	Required	The name of the profile
<config>	Required	Video mode dependent quality settings for profile (see below)

Config Element

The <config> element defines a mapping between the video resolution and frame rate and the target bitrate for the quality level. The <config> element is a child of the <profile> element.

The following is an example of a <config> element block for setting the target bitrate for a high quality stream with 720p60 and 1080p60 video inputs.

```
<profile>
  <name>Streaming High</name>
  <config resolution="720p" fps="60" codec="H264">
    <bitrate>6000000</bitrate>
    <audio-bitrate>128000</audio-bitrate>
  </config>
  <config resolution="1080p" fps="60" codec="H264">
    <bitrate>8000000</bitrate>
    <audio-bitrate>128000</audio-bitrate>
  </config>
  <!-- <config> elements for other resolutions and frame rates -->
</profile>
```

Attributes

Attribute	Optional/Required	Description
resolution	Required	The resolution of the streaming video mode
fps	Required	The frame rate of the streaming video mode (frames per second)
codec	Optional	The codec for encoding the streaming video - "H264" (default) or "H265"

Child Elements

Element	Optional/Required	Description
<bitrate>	Required	The target bitrate of the streaming video (bits per second)
<audio-bitrate>	Optional	The target bitrate of the streaming audio (bits per second)

The supported streaming quality bitrates can be found in section `Using Web Presenter Setup` section earlier in this manual.

TIP For each <config> element block, choose a maximum resolution and fps to cover all video modes for the target bitrate. For example, defining a <config> element with resolution="1080p" and fps = "30" will apply for video modes 1080p23.98, 1080p24, 1080p25, 1080p29.97 and 1080p30.

For audio bitrate, only 128 Kb/s is supported.

Credentials Element

The <credentials> element allows specifying an RTMP session username and password if required by the service. The <credentials> element is an optional child to service element.

The following is an example of a <credentials> element block that defines a username and password for the streaming service.

```
<service>
  ...
  <credentials>
    <username>myusername</username>
    <password>abcd1234</password>
  </credentials>
  ...
</service>
```

Child Elements

Element	Optional/Required	Description
<username>	Required	RTMP session username
<password>	Required	RTMP/SRT session password

Hilfe

So erhalten Sie Hilfe

Am schnellsten erhalten Sie Hilfe online über die Support-Seiten der Website von Blackmagic Design. Sehen Sie dort nach dem aktuellsten Support-Material für Ihren Blackmagic Web Presenter.

Blackmagic Design Online Support Seiten

Das aktuellste Handbuch finden Sie im Blackmagic Support Center unter www.blackmagicdesign.com/de/support.

Blackmagic Design Forum

Das Blackmagic Design Forum auf unserer Website ist eine praktische Ressource für weitere Informationen und kreative Ideen. Manchmal finden Sie dort schneller Lösungen, da möglicherweise bereits hilfreiche Antworten auf ähnliche Fragen von anderen erfahrenen Anwendern und Blackmagic Design Mitarbeitern vorliegen. Das Forum finden Sie unter <http://forum.blackmagicdesign.com>.

Kontaktaufnahme mit Blackmagic Design Support

Wenn unser Support-Material oder das Forum Ihnen nicht wie gewünscht hilft, gehen Sie bitte auf unsere Support-Seite und schicken Sie uns Ihre Anfrage über den Button „Senden Sie uns eine E-Mail“. Oder klicken Sie auf „Finden Sie Ihr lokales Support-Team“ und rufen Sie Ihre nächstgelegene Blackmagic Design Support-Stelle an.

Gesetzliche Vorschriften



Entsorgung von elektrischen und elektronischen Geräten innerhalb der Europäischen Union

Das auf dem Produkt abgebildete Symbol weist darauf hin, dass dieses Gerät nicht zusammen mit anderen Abfallstoffen entsorgt werden darf. Altgeräte müssen daher zur Wiederverwertung an eine dafür vorgesehene Sammelstelle übergeben werden. Mülltrennung und Wiederverwertung von Altgeräten tragen zum nachhaltigen Umgang mit natürlichen Ressourcen bei. Gleichzeitig wird sichergestellt, dass die Wiederverwertung nicht zulasten der menschlichen Gesundheit und der Umwelt geht. Weitere Informationen zur Entsorgung von Altgeräten sowie zu den Standorten der zuständigen Sammelstellen erhalten Sie von Ihren örtlichen Müllentsorgungsbetrieben sowie vom Händler, bei dem Sie dieses Produkt erworben haben.



Dieses Gerät wurde geprüft und entspricht den Grenzwerten für Digitalgeräte der Klasse A gemäß Abschnitt 15 der FCC-Bestimmungen für Funkentstörung. Diese Grenzwerte dienen dem angemessenen Schutz gegen schädliche Störungen bei Betrieb des Geräts in einer gewerblichen Umgebung. Geräte dieser Art erzeugen und verwenden Hochfrequenzen und können diese auch ausstrahlen. Bei Nichteinhaltung der Installations- und Gebrauchsvorschriften können sie zu Störungen beim Rundfunkempfang führen. Der Betrieb solcher Geräte im Wohnbereich führt mit großer Wahrscheinlichkeit zu Funkstörungen. In diesem Fall kann vom Betreiber verlangt werden, selbst für die Beseitigung solcher Störungen aufzukommen.

interference, in which case the user will be required to correct the interference at personal expense.

Der Betrieb unterliegt den beiden folgenden Bedingungen:

- 1 Das Gerät darf keine schädigenden Störungen hervorrufen.
- 2 Das Gerät muss unanfällig gegenüber beliebigen empfangenen Störungen sein, einschließlich solcher, die einen unerwünschten Betrieb verursachen.



R-R-BMD-20201201001
R-R-BMD-20201201002

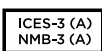

ISED-Zertifizierung für den kanadischen Markt

Dieses Gerät erfüllt die kanadischen Vorschriften für digitale Geräte der Klasse A.

Jedwede an diesem Produkt vorgenommene Änderung oder unsachgemäße Verwendung kann die Konformitätserklärung zum Erlöschen bringen.

Verbindungen zu HDMI-Schnittstellen müssen über abgeschirmte HDMI-Kabel hergestellt werden.

Die Ausstattung wurde unter Einhaltung der beabsichtigten Nutzung in einer gewerblichen Umgebung getestet. Bei Verwendung in häuslichen Umgebungen können Funkstörungen auftreten.

Sicherheitshinweise

Zum Schutz vor Stromschlag muss das Gerät an ein vorschriftsmäßig geerdetes Stromnetz angeschlossen werden.

Um das Risiko eines Stromschlages zu verringern, setzen Sie das Gerät weder Tropfen noch Spritzern aus.

Das Gerät eignet sich für den Einsatz in tropischen Gebieten mit einer Umgebungstemperatur von bis zu 40 °C.

Die Lagertemperatur ist -20–60 °C bei einer relativen Luftfeuchtigkeit von 0–90 % nichtkondensierend.

Achten Sie auf eine ausreichende Luftzufuhr um das Gerät herum, sodass die Belüftung nicht eingeschränkt wird.

Achten Sie bei der Installation im Rack darauf, dass die Luftzufuhr nicht durch andere Geräte eingeschränkt wird.

Im Inneren des Gehäuses befinden sich keine durch den Anwender zu wartenden Teile. Wenden Sie sich für die Wartung an ein Blackmagic Design Service Center in Ihrer Nähe.



Nur in Höhen bis 2000 m über dem Meeresspiegel einsetzen.

California Proposition 65

Plastikteile dieses Produkts können Spuren von polybromierten Biphenylen enthalten. Im US-amerikanischen Bundesstaat Kalifornien werden diese Chemikalien mit Krebs, Geburtsfehlern und anderen Schäden der Fortpflanzungsfähigkeit in Verbindung gebracht.

Weitere Informationen finden Sie unter www.P65Warnings.ca.gov.

Garantie

36 Monate eingeschränkte Garantie

Für den Blackmagic Web Presenter gewährt Blackmagic Design eine Garantie auf Material- und Verarbeitungsfehler von 36 Monaten ab Kaufdatum mit Ausnahme von Steckverbindern, Kabeln, Glasfasermodulen, Sicherungen und Batterien, für die eine Garantie auf Material- und Verarbeitungsfehler von 12 Monaten ab dem Kaufdatum gewährt wird. Sollte sich das Produkt innerhalb dieser Garantiezeit als fehlerhaft erweisen, wird die Firma Blackmagic Design nach ihrem Ermessen das defekte Produkt entweder ohne Kostenerhebung für Teile und Arbeitszeit reparieren oder Ihnen das defekte Produkt ersetzen.

Zur Inanspruchnahme der Garantieleistungen müssen Sie als Kunde Blackmagic Design über den Defekt innerhalb der Garantiezeit in Kenntnis setzen und die entsprechenden Vorkehrungen für die Leistungserbringung treffen. Es obliegt dem Kunden, für die Verpackung und den bezahlten Versand des defekten Produkts an ein spezielles von Blackmagic Design benanntes Service Center zu sorgen und hierfür aufzukommen. Sämtliche Versandkosten, Versicherungen, Zölle, Steuern und sonstige Abgaben im Zusammenhang mit der Rücksendung von Waren an uns, ungeachtet des Grundes, sind vom Kunden zu tragen.

Diese Garantie gilt nicht für Mängel, Fehler oder Schäden, die durch unsachgemäße Handhabung oder unsachgemäße oder unzureichende Wartung und Pflege verursacht wurden. Blackmagic Design ist im Rahmen dieser Garantie nicht verpflichtet, die folgenden Serviceleistungen zu erbringen: a) Behebung von Schäden infolge von Versuchen Dritter, die Installation, Reparatur oder Wartung des Produkts vorzunehmen, b) Behebung von Schäden aufgrund von unsachgemäßer Handhabung oder Anschluss an nicht kompatible Geräte, c) Behebung von Schäden oder Störungen, die durch die Verwendung von nicht Blackmagic-Design-Ersatzteilen oder -Verbrauchsmaterialien entstanden sind, d) Service für ein Produkt, das verändert oder in andere Produkte integriert wurde, sofern eine solche Änderung oder Integration zu einer Erhöhung des Zeitaufwands oder zu Schwierigkeiten bei der Wartung des Produkts führt. ÜBER DIE IN DIESER GARANTIEERKLÄRUNG AUSDRÜCKLICH AUFGEFÜHRTE ANSPRÜCHE HINAUS ÜBERNIMMT BLACKMAGIC DESIGN KEINE WEITEREN GARANTIEEN, WEDER AUSDRÜCKLICH NOCH STILLSCHWEIGEND. DIE FIRMA BLACKMAGIC DESIGN UND IHRE HÄNDLER LEHNEN JEDLICHE STILLSCHWEIGENDEN GARANTIEEN IN BEZUG AUF AUSSAGEN ZUR MARKTGÄNGIGKEIT UND GEBRAUCHSTAUGLICHKEIT FÜR EINEN BESTIMMTEN ZWECK AB. DIE VERANTWORTUNG VON BLACKMAGIC DESIGN, FEHLERHAFTE PRODUKTE ZU REPARIEREN ODER ZU ERSETZEN, IST DIE EINZIGE UND AUSSCHLIESSLICHE ABHILFE, DIE GEGENÜBER DEM KUNDEN FÜR ALLE INDIREKTEN, SPEZIELLEN, NEBEN- ODER FOLGESCHÄDEN ZUR VERFÜGUNG GESTELLT WIRD, UNABHÄNGIG DAVON, OB BLACKMAGIC DESIGN ODER DER HÄNDLER VON DER MÖGLICHKEIT SOLCHER SCHÄDEN ZUVOR IN KENNTNIS GESETZT WURDE. BLACKMAGIC DESIGN IST NICHT HAFTBAR FÜR JEDLICHE WIDERRECHTLICHE VERWENDUNG DER GERÄTE DURCH DEN KUNDEN. BLACKMAGIC HAFTET NICHT FÜR SCHÄDEN, DIE SICH AUS DER VERWENDUNG DES PRODUKTS ERGEBEN. NUTZUNG DES PRODUKTS AUF EIGENE GEFAHR.

© Copyright 2023 Blackmagic Design. Alle Rechte vorbehalten. „Blackmagic Design“, „DeckLink“, „HDLink“, „Workgroup Videohub“, „Multibridge Pro“, „Multibridge Extreme“, „Intensity“ und „Leading the creative video revolution“ sind eingetragene Warenzeichen in den USA und anderen Ländern. Alle anderen Unternehmens- und Produktnamen sind möglicherweise Warenzeichen der jeweiligen Firmen, mit denen sie verbunden sind.

Thunderbolt und das Thunderbolt-Logo sind Warenzeichen der Firma Intel Corporation in den USA bzw. in anderen Ländern.

Blackmagic Web Presenter





Bienvenido

Gracias por haber adquirido este producto.

El dispositivo Blackmagic Web Presenter se conecta directamente a cualquier equipo SDI y permite obtener una señal en formato H.264 para poder emitirla a través de plataformas populares, tales como YouTube Live, Facebook Live y Twitch. A su vez, mediante un conversor ATEM Streaming Bridge opcional, es posible transmitir las imágenes punto a punto con calidad profesional. Esto facilita la transmisión de contenido audiovisual a lugares remotos por Internet.

Este manual de instrucciones incluye todo lo necesario para comenzar a emplear el dispositivo y utilizar sus controles y prestaciones. Asimismo, explica cómo configurarlo a fin de transmitir a través de YouTube Live, Facebook Live, Twitch, Zoom, Skype y otras plataformas similares.

En nuestra página de soporte encontrarás la versión más reciente de este manual, así como material de apoyo adicional para este producto. Por último, no olvides registrarte al descargar las actualizaciones, a fin de que podamos mantenerte informado sobre nuevos lanzamientos.

Trabajamos constantemente para desarrollar herramientas innovadoras y superarnos, de modo que nos encantaría conocer tu opinión.

A handwritten signature in black ink that reads "Grant Petty". The signature is written in a cursive, flowing style.

Grant Petty

Director ejecutivo de Blackmagic Design

Índice

Primeros pasos	217
Panel frontal del dispositivo	220
Pantalla LCD	221
Uso de la salida de monitorización	222
Uso del programa Web Presenter Setup	227
Transmisión	228
Configuración	231
Ajustes de red	232
Compartir la conexión a Internet para la transmisión	232
Transmisión mediante teléfonos móviles	233
Uso del dispositivo como cámara web	233
Configuración de Open Broadcaster	233
Creación de enlaces con el modelo ATEM Streaming Bridge	236
Crear el archivo XML	237
Exportar el archivo XML	237
Luz piloto, comunicación y control de cámaras	238
Conexión del modelo URSA Broadcast G2	239
Blackmagic Universal Rack Shelf	240
Índice	240
Instalación de una unidad en el estante	241
Instalación de la placa ciega de 1/6	241
Instalación de la placa ciega de 1/3	241
Actualización del dispositivo	242
Developer Information	243
Blackmagic Web Presenter Ethernet Protocol	243
Protocol Blocks	245
Blackmagic Streaming XML Format	256
Overview	256
Streaming XML Definition	256
Ayuda	263
Normativas	264
Seguridad	265
Garantía	266

Primeros pasos

Para comenzar a usar el dispositivo, basta con enchufarlo a la red de suministro eléctrico, conectar las fuentes audiovisuales a la unidad, y finalmente esta a Internet y a un equipo informático.

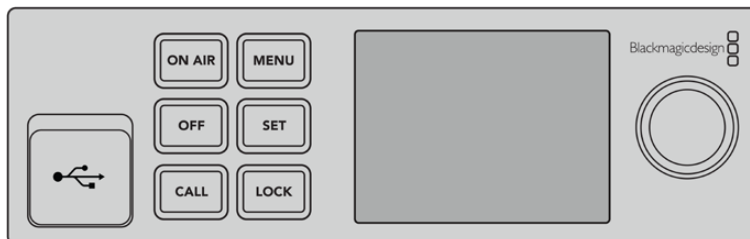

Panel frontal del dispositivo

Conexión del dispositivo

Conecte un cable IEC convencional a la entrada de alimentación situada en el panel trasero del dispositivo.

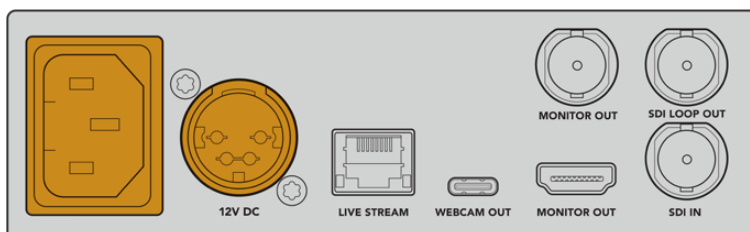

El dispositivo puede alimentarse mediante el cable IEC o una fuente de 12 V para corriente continua.

Este equipo incluye una entrada para corriente continua de 12 V que puede emplearse con el propósito de utilizar fuentes de alimentación externas o redundantes, tales como un sistema de alimentación ininterrumpida o una batería externa de 12 V.

Conexión de fuentes audiovisuales

Conecte la fuente a la entrada SDI del dispositivo. Las imágenes se verán en la pantalla LCD del panel frontal. El audio se encuentra integrado en la señal SDI, y es posible verificar su presencia observando los vómetros.

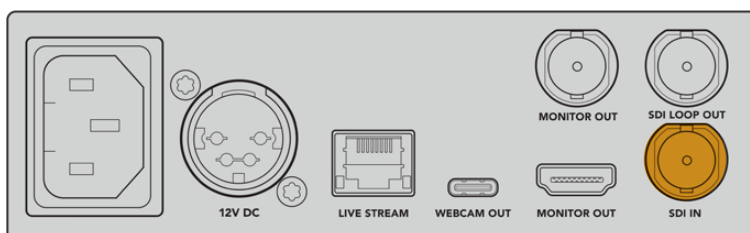

Conecte una fuente a la entrada SDI del dispositivo.

La unidad incluye tecnología SDI 12G, de modo que admite fuentes con una resolución máxima de 2160p60 y ajusta automáticamente su definición. Aunque el modelo Blackmagic Web Presenter 4K es capaz de transmitir en UHD, la versión Blackmagic Web Presenter HD disminuye la resolución de cualquier señal recibida a 1080p.

Conexión a monitores

Conecte un monitor SDI o un televisor HDMI a una de las salidas del dispositivo, a fin de supervisar las imágenes y observar datos importantes sobre el estado de la señal. Consulte el apartado *Uso de la salida de monitorización* a efectos de obtener más información al respecto.

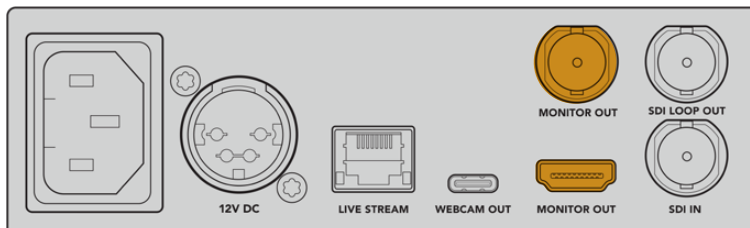

Conecte un monitor a la salida correspondiente del dispositivo.

Conexión a equipos informáticos mediante el puerto USB

Conecte el dispositivo a un equipo informático mediante el puerto USB en el panel delantero o trasero. Estas conexiones permiten actualizar la unidad y configurarla a través del programa utilitario. Una vez configurada, es posible desconectarla del equipo informático.

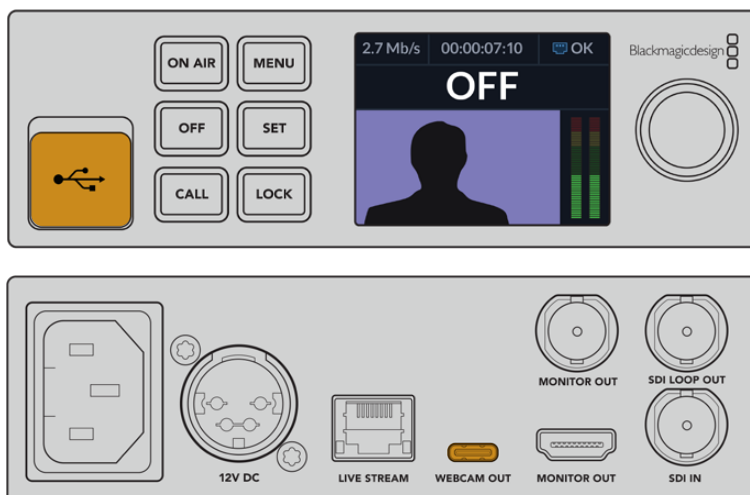

Conecte el dispositivo a un equipo informático mediante el puerto USB en el panel delantero o trasero.

Conexión a Internet

Conecte el puerto Ethernet de la unidad a un conmutador de red mediante el cable correspondiente.

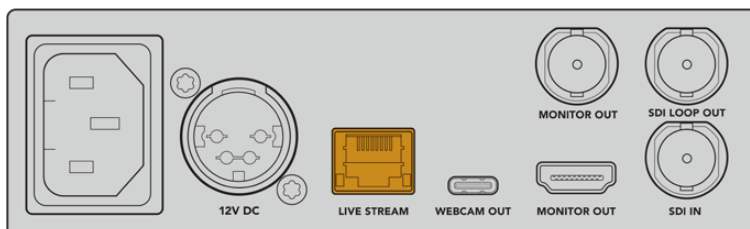

Conecte el dispositivo a una red mediante el puerto Ethernet en el panel trasero.

Configuración de la transmisión

A continuación, es posible configurar el dispositivo para transmitir mediante plataformas tales como YouTube Live, Facebook Live, Twitch y otras similares. En el siguiente ejemplo, se explica cómo configurar una transmisión en YouTube Live.

- 1 Copie la clave de transmisión proporcionada por YouTube Studio.
- 2 Descargue el programa Blackmagic Web Presenter Setup desde nuestro sitio web e instálelo en el equipo informático. Este permite configurar los ajustes de la transmisión por primera vez.
- 3 Ejecute el programa utilitario y seleccione la pestaña **Live Stream**.
- 4 Elija **YouTube** como plataforma y seleccione la opción **Primary** para el servidor. Copie la clave de la transmisión en el campo **Key** y seleccione la calidad. Haga clic en **Save** para guardar los ajustes.
- 5 Ya está todo listo para comenzar la transmisión. Haga clic en la opción **ON AIR** o presione el botón correspondiente en el panel frontal de la unidad. Al finalizar el programa, haga clic en el botón **OFF** para detener la transmisión.

Uso del protocolo SRT

El protocolo de transporte seguro y confiable (SRT) ofrece una latencia menor en comparación con el protocolo de mensajería en tiempo real (RTMP). Además, brinda una mayor seguridad al utilizar una frase de contraseña, que es similar a una clave de cifrado.

Cuando seleccione la versión del protocolo SRT del dispositivo, copie la frase de contraseña y la clave de transmisión de su cuenta y péguelas en los campos **Passphrase** y **Key** del programa utilitario, respectivamente.

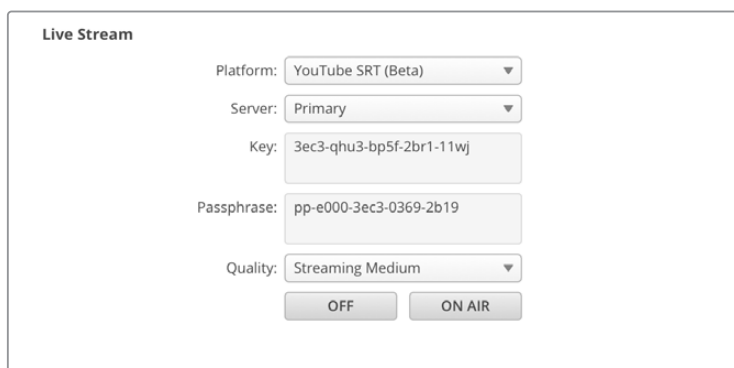

The screenshot shows a configuration window titled "Live Stream". It contains the following fields and values:

- Platform: YouTube SRT (Beta)
- Server: Primary
- Key: 3ec3-qhu3-bp5f-2br1-11wj
- Passphrase: pp-e000-3ec3-0369-2b19
- Quality: Streaming Medium

At the bottom of the window, there are two buttons: "OFF" and "ON AIR".

Pegue la frase de contraseña en el campo **Passphrase** del programa utilitario.

Es posible cambiar el protocolo (RTMP o SRT) y el códec (H.264 o H.265) en el archivo XML si se cuenta con la experiencia técnica, a fin de personalizar los ajustes de transmisión. Consulte el apartado correspondiente al formato de dicho archivo en este manual para obtener más información al respecto.

Panel frontal del dispositivo

Los controles del panel frontal permiten comenzar y detener la transmisión, así como cambiar los ajustes.

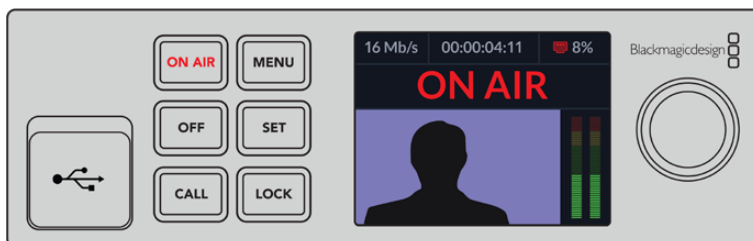

ON AIR - Presione este botón para comenzar la transmisión. Este se encenderá de rojo mientras la señal está al aire.



Si el botón parpadea, significa que no ha sido posible iniciar la transmisión o que esta se ha detenido inesperadamente. Esto puede deberse a un problema con la conexión a Internet o la configuración. Verifique que la conexión funcione correctamente y que los ajustes sean correctos.

OFF - Presione este botón para detener la transmisión.

MENU - Presione este botón para acceder al menú de ajustes.

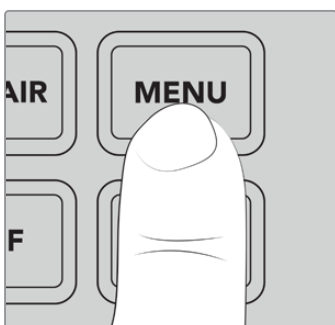

Para modificar un ajuste:

- 1 Mueva el mando giratorio para seleccionar el parámetro que desea modificar y presione **SET**.



- 2 Gire el mando para cambiar el ajuste.
- 3 Presione **SET** nuevamente para confirmar los cambios.

Presione el botón **MENU** para salir y regresar a la pantalla principal.

CALL - Esta función estará disponible próximamente.

LOCK - Mantenga presionado este botón durante un segundo para bloquear el panel frontal. Esto evita que una señal se emita al aire accidentalmente o que la transmisión se detenga de forma inesperada. El botón se enciende de rojo cuando el panel frontal está bloqueado.

Mantenga presionado este botón durante dos segundos para desbloquear el panel frontal.

Pantalla LCD

La pantalla principal es lo primero que aparece al encender la unidad. Esta brinda información importante, por ejemplo:

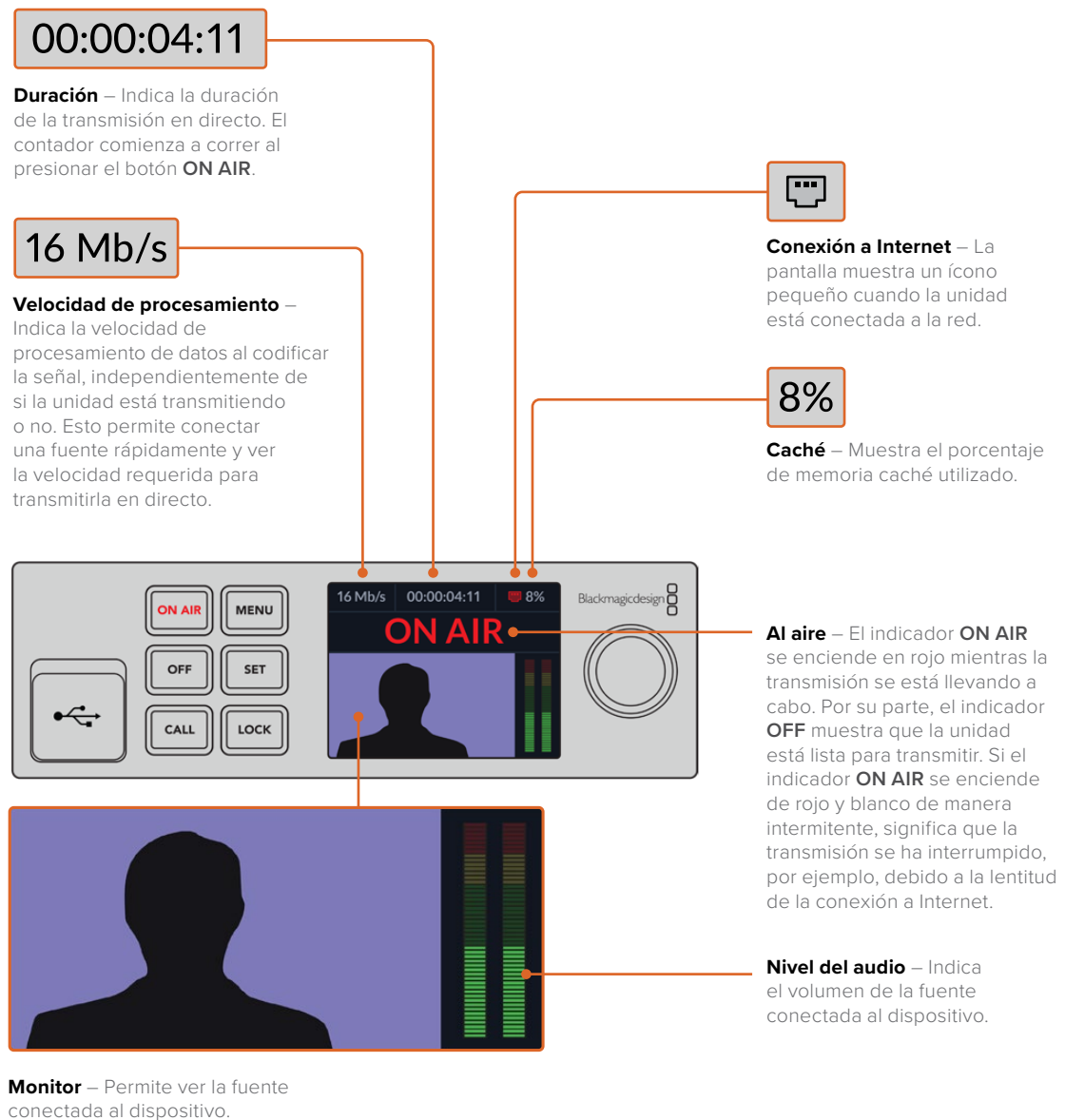

Íconos de la conexión a Internet



Este ícono aparece cuando hay un cable de red conectado y se utiliza una conexión Ethernet para la transmisión.



Este ícono aparece cuando la transmisión se está llevando a cabo mediante la red Ethernet.



Este ícono aparece cuando se utiliza la conexión a Internet de un teléfono móvil para la transmisión.



Este ícono aparece cuando la transmisión se está llevando a cabo mediante la conexión a Internet de un teléfono móvil.

SUGERENCIA: Si no aparece ninguno de los íconos anteriores, la unidad no está conectada a la red.

Uso de la salida de monitorización

Esta salida permite supervisar la fuente, el nivel del audio, el estado de la transmisión, la velocidad de transferencia y el uso de la memoria caché, además de brindar información acerca de la señal SDI.



La salida de monitorización del dispositivo permite ver abundante información, por ejemplo, la velocidad de transferencia y el estado de la memoria caché.

A continuación se describen los ocho paneles que componen la imagen y los datos que proporcionan.

Señal

El panel principal muestra la imagen correspondiente a la fuente SDI conectada.



Indicador de señal al aire

Antes de comenzar la transmisión, el indicador **OFF AIR** muestra que la unidad está lista. Cuando esta se inicia, el indicador **ON AIR** aparecerá en rojo hasta que se detenga.



El contador de la duración situado debajo del indicador se activa al presionar el botón **ON AIR**.

Si la unidad no está al aire y la transmisión se llevará a cabo mediante la conexión a Internet de un teléfono móvil, aparecerá un ícono azul en la esquina superior derecha. Este se iluminará de color rojo cuando la señal esté al aire.

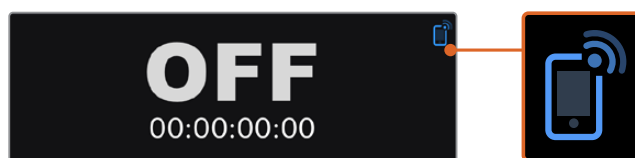

Transmisión en directo

Este panel brinda información sobre los ajustes de la transmisión, que incluyen la plataforma, el servidor y el protocolo. Asimismo, muestra la resolución y la calidad.

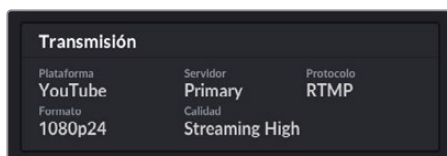

Fuente

Las 5 imágenes pequeñas en la parte superior de este panel corresponden a los 6 segundos previos de la transmisión. Cada una equivale a 1.2 segundos.

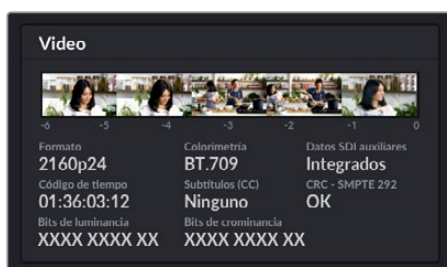

Debajo de estas, se brinda información técnica sobre la fuente conectada a la entrada SDI del dispositivo.

Formato	Indica la resolución y la frecuencia de imagen de la fuente SDI. El dispositivo admite una resolución máxima de 2160p60.
Colorimetría	Indica el espacio cromático de la fuente SDI. El dispositivo admite los espacios Rec.601, Rec.709 y Rec.2020.
Datos SDI auxiliares	Los datos auxiliares están integrados en la señal SDI y comprenden el audio, el código de tiempo y los subtítulos opcionales (CC). Si la fuente incluye dichos datos, el indicador dirá Presentes.

Código de tiempo	Indica el código de tiempo de la fuente SDI.
Subtítulos opcionales	Indica el formato de los subtítulos opcionales (CC) si están presentes en la señal. El dispositivo admite los formatos CEA-608 y CEA-708.
CRC - SMPTE 292	Indica los errores detectados por el dispositivo en la fuente SDI. Estos pueden deberse al uso de cables defectuosos o demasiado largos.
Bits de luminancia (Y) y crominancia	<p>Estos indicadores muestran la actividad de la fuente SDI. Cada letra representa el estado de un bit de la señal.</p> <p>X - Representa un bit que cambia constantemente. L - Representa un bit menos significativo. H - Representa un bit más significativo.</p> <p>Las compensaciones SDI se restan para facilitar la comprensión. Por ejemplo, cuando la señal consiste en una imagen negra, ningún bit es significativo.</p> <p>Generalmente, los 10 bits correspondientes a la fuente SDI se representan mediante una X, ya que cambian constantemente.</p> <p>Si la señal es de 8 bits, los dos situados en el extremo derecho siempre se representan mediante una L, ya que no contienen datos. Cuando un bit que debería ser X aparece representado mediante una L o una H, significa que se ha «atascado», y esto podría indicar una falla en la señal.</p>

Audio

La forma de onda en la parte superior de este panel muestra la información del audio correspondiente a los 6 segundos previos de la transmisión. y se actualiza constantemente.

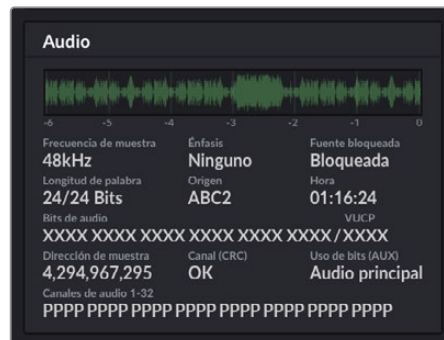

Debajo de esta, se brindan datos técnicos sobre la fuente.

Frecuencia de muestra	Indica la frecuencia de la muestra de audio integrada en la señal SDI.
Énfasis	Indica si dicha opción está activada.
Fuente sincronizada	Indica si la fuente de audio está sincronizada con una señal de referencia externa.
Longitud de palabra	Indica la profundidad de bits del audio integrado en la señal SDI.
Origen	Estos cuatro caracteres indican el canal de origen.
Hora	Hora del día
Bits de audio	Indica la actividad de los bits en las muestras de audio integradas en la señal SDI y permite confirmar su presencia.
VUCP	De izquierda a derecha, estas letras indican la validez (V), el bit de usuario (U), el estado del canal (C) y la paridad (P). Este campo funciona de manera similar al indicador correspondiente a los bits de audio.
Dirección de muestra	Contador para la muestra de audio.
Uso de bits (AUX)	Indica el uso de bits auxiliares en la señal de audio.
Canales de audio 1-32	Cada dígito representa un canal de audio integrado en la señal SDI. Una P indica que el canal está en uso, mientras que un guion hace referencia a la ausencia de audio en dicho canal.

Velocidad de transferencia

Este panel muestra la velocidad de la codificación durante los 60 segundos previos en megabits por segundo. El indicador funciona constantemente, incluso cuando la señal no está al aire, a fin de poder determinar el ancho de banda necesario para la transmisión.

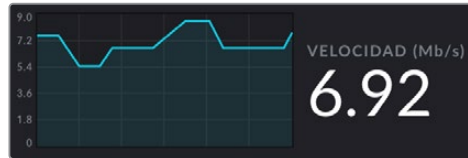

Memoria caché

El indicador y la gráfica muestran el porcentaje de la memoria intermedia utilizado durante los 60 segundos previos. Esta es una memoria interna con capacidad limitada que graba y reproduce la señal transmitida de manera continua. Funciona como una medida de seguridad en caso de que la velocidad de transmisión disminuya.

La naturaleza variable de Internet se debe mayoritariamente a la actividad de la red o a la potencia de la señal inalámbrica. De este modo, si la velocidad de transferencia disminuye, se almacenarán más datos en la memoria caché a fin de compensar la falta de velocidad requerida para la transmisión. Sin embargo, cuando su capacidad se agote, la transmisión se verá comprometida, por lo que es recomendable evitar que esto suceda siempre que sea posible. Para realizar una prueba, conecte una fuente y observe el indicador sin comenzar la transmisión. Si este se aproxima al 100 % con frecuencia, seleccione una calidad inferior en los ajustes para la transmisión.



Nivel del audio

Los medidores indican la intensidad de la señal de audio según la opción seleccionada en el menú de ajustes del dispositivo (PPM o VU). Si el volumen es demasiado alto, los indicadores se encenderán de rojo, y podría ocurrir una distorsión en el audio de la transmisión. Intente que el nivel no rebase demasiado la parte superior de la sección verde.

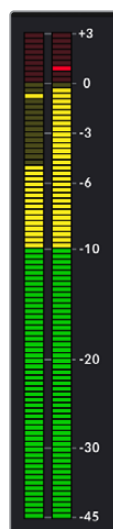

Uso del programa Web Presenter Setup

Cuando el dispositivo se encuentra conectado a una red, es posible emplear cualquier equipo informático para controlarlo a distancia. En tal sentido, el programa Web Presenter Setup permite acceder a todos los controles y ajustes disponibles en el panel frontal de la unidad.

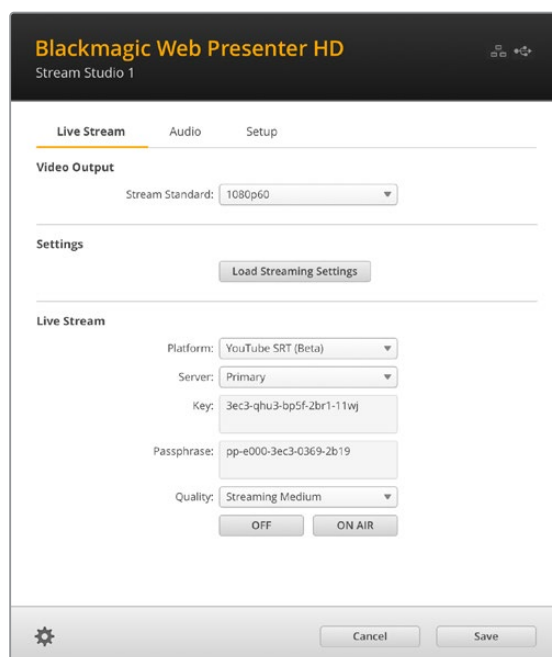
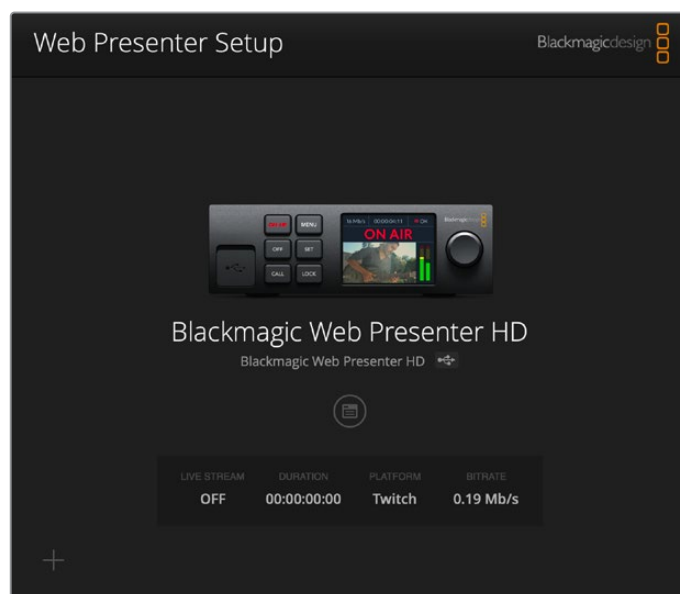

Transmisión

Señal saliente

Formato de transmisión

Esta opción permite seleccionar la resolución de la señal transmitida. Según el modelo, las opciones disponibles varían entre 720p25 y 1080p60 o 2160p60.

Ajustes

El botón **Load Streaming Settings** permite importar ajustes de transmisión personalizados almacenados en archivos XML, por ejemplo, desde conversores Blackmagic ATEM Streaming Bridge.

Consulte el apartado correspondiente a este dispositivo para obtener más información al respecto.

Transmisión en directo

Plataforma

El menú **Platform** permite seleccionar la plataforma para la transmisión. Las opciones disponibles incluyen YouTube, Facebook y Twitch. Al importar ajustes personalizados, estos también aparecerán en la lista.

Para transmitir a una dirección URL, seleccione una opción específica en el menú **Platform**. El modelo Web Presenter 4K permite transmitir a una dirección URL particular en formato H.264 o H.265, mientras que, en la versión Web Presenter HD, solo es posible hacerlo a través del códec H.264.

Servidor

El menú **Server** permite seleccionar el servidor más cercano. La lista de opciones disponibles varía según la plataforma de transmisión elegida.

Al transmitir a través de Instagram, Microsoft Teams o una dirección URL específica, la lista de servidores puede modificarse. Ingrese la dirección asignada por la plataforma de transmisión o los datos correspondientes.

Clave

El campo **Key** se utiliza para introducir la clave asignada por la plataforma de transmisión.

Frase de contraseña

Al utilizar un servicio de transmisión con el protocolo SRT, ingrese la frase de contraseña asignada por la plataforma.

Calidad

Seleccione la calidad de la transmisión según el modelo utilizado.

H.264	
HD	4K
HyperDeck High (45-70 Mb/s)	HyperDeck High (95-220 Mb/s)
HyperDeck Medium (25-45 Mb/s)	HyperDeck Medium (66-150 Mb/s)
HyperDeck Low (12-20 Mb/s)	HyperDeck Low (38-80 Mb/s)
Streaming High (6-9 Mb/s)	Streaming High (34-51 Mb/s)
Streaming Medium (4.5-7 Mb/s)	Streaming Medium (23-35 Mb/s)
Streaming Low (3-4.5 Mb/s)	Streaming Low (13-20 Mb/s)

H.265	
HD	4K
Streaming High (2.3-4.5 Mb/s)	Streaming High (22.5-30 Mb/s)
Streaming Medium (1.5-3 Mb/s)	Streaming Medium (14-20 Mb/s)
Streaming Low (0.8-2 Mb/s)	Streaming Low (8-10 Mb/s)

La velocidad de transmisión dependerá del formato empleado por el dispositivo. Por ejemplo, al seleccionar la opción **Streaming High** para transmitir una señal en formato 1080p24, la velocidad de transmisión será de 6 Mb/s.

Como se aprecia en la tabla, las velocidades de transferencia de datos son menores a las de las opciones HyperDeck. Esto permite transmitir por Internet, puesto que durante este proceso el ancho de banda es menor que el utilizado al grabar información en un disco.

Nótese que para cada ajuste se mencionan dos velocidades. La inferior se emplea con frecuencias de imagen de 24p, 25p y 30p, mientras que la superior corresponde a valores de 50p y 60p. Asimismo, cabe mencionar que la opción predeterminada para la transmisión es **Streaming High** (6-9 Mb/s), ya que brinda la mejor calidad.

Botones de señal al aire

Los botones **ON AIR** y **OFF** permiten iniciar o detener la transmisión, respectivamente. El primero se enciende de color rojo cuando la transmisión se está llevando a cabo.

Eliminar ajustes importados

Para eliminar los ajustes importados del dispositivo, haga clic en el ícono de la rueda dentada en la esquina inferior izquierda de la pestaña **Live Stream**. A continuación, haga clic en el botón **Remove** para confirmar.

Audio

Esta pestaña incluye opciones para configurar la salida para supervisar el audio y los medidores del nivel de la señal.

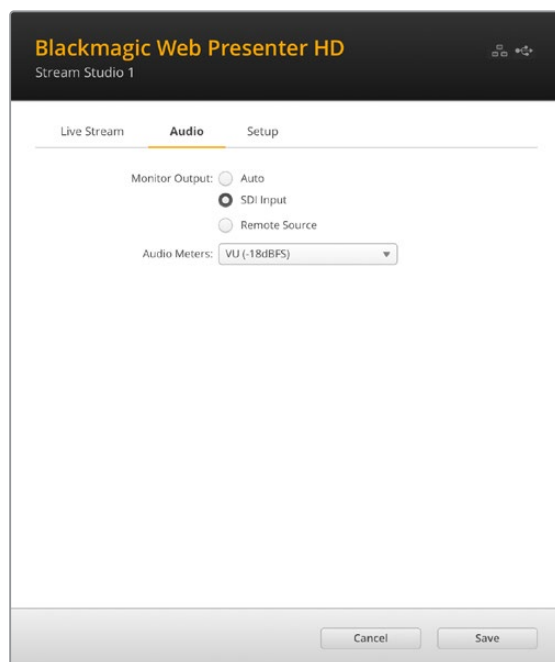

Monitorización

La opción **Monitor Output** seleccionar la fuente de audio transmitida a través de las salidas de monitorización SDI y HDMI del dispositivo.

Auto

Al seleccionar la opción automática, el dispositivo detectará automáticamente el audio de la comunicación que se transmite del mezclador ATEM a la unidad ATEM Streaming Bridge. Si este no se detecta, se supervisará el audio recibido a través de la entrada SDI.

Entrada SDI

Seleccione esta opción para supervisar el audio de una fuente SDI, por ejemplo, una unidad Blackmagic Studio Camera conectada al dispositivo.

Fuente remota

Seleccione esta opción para supervisar el audio de la comunicación transmitido desde un mezclador ATEM o una unidad ATEM Streaming Bridge conectados remotamente.

Nivel del audio

Este menú permite elegir el sistema empleado para la medición del audio. Las opciones disponibles son **VU -18dBFS**, **VU -20dBFS**, **PPM -18dBFS** y **PPM -20dBFS**.

Configuración

The screenshot shows the 'Setup' configuration page for a Blackmagic Web Presenter HD. The page has three tabs: 'Live Stream', 'Audio', and 'Setup'. The 'Setup' tab is selected. Under the 'Setup' tab, there are three input fields: 'Name' (Stream Studio 1), 'Language' (English), and 'Software' (Version 3.3). Below these is a 'Network' section with a refresh icon. The 'Network' section has radio buttons for 'Protocol' (DCHP and Static IP), 'IP Address' (192.168.24.100), 'Subnet Mask' (255.255.255.0), 'Gateway' (192.168.24.1), 'Primary DNS' (8.8.8.8), and 'Secondary DNS' (8.8.4.4). There are also radio buttons for 'Connection Priority' (Ethernet and Mobile). At the bottom of the 'Network' section is a 'Factory Reset' button. At the very bottom of the interface are 'Cancel' and 'Save' buttons.

Nombre

El campo **Name** en la pestaña **Setup** permite introducir un nombre para la unidad. Haga clic en el botón **Save** a fin de guardar los cambios.

Idioma

La opción **Language** permite cambiar el idioma en el que se muestran los diversos ajustes.

Software

Indica la versión del programa instalada.

Red

Los ajustes de la sección **Network** permiten configurar diversas opciones, tales como el uso de una dirección estática o el protocolo DHCP. Consulte el apartado *Ajustes de red* para obtener más información al respecto.

Prioridad de la conexión

Al conectar el dispositivo a una red Ethernet y un teléfono móvil, la opción **Connection Priority** permite seleccionar la conexión empleada para la transmisión. Consulte el apartado *Transmisión mediante teléfonos móviles* para obtener más información al respecto.

Restablecer

El botón **Factory Reset** permite restablecer la configuración original del dispositivo.

Ajustes de red

El dispositivo puede conectarse a una red mediante una dirección IP fija o el protocolo DHCP.

DHCP - Esta opción asigna automáticamente una dirección IP a la unidad para conectarla a la red sin cambiar los ajustes.

El protocolo de configuración dinámica o DHCP permite a los servidores de red reconocer automáticamente el dispositivo y asignarle una dirección IP. A su vez, facilita la conexión de equipos mediante redes Ethernet y garantiza que no haya un conflicto entre las direcciones IP. La mayoría de los equipos informáticos y conmutadores de red admiten el uso de este protocolo.

IP fija - Para asignar una dirección IP a la unidad, seleccione la opción **Static IP** y modifique los ajustes manualmente.

La dirección IP fija no cambia, incluso al reiniciar el dispositivo.

Puede que resulte necesario recurrir a esta última opción al conectar el dispositivo a redes corporativas. Si su empresa cuenta con un administrador de red, es posible haya direcciones IP específicas para todos los equipos conectados a la misma. Recomendamos comprobar si el administrador de red gestiona los equipos informáticos y la red en la empresa.

Compartir la conexión a Internet para la transmisión

Si no es posible conectar la unidad directamente a un conmutador de red, se brinda la oportunidad de compartir la conexión a Internet del equipo informático mediante el puerto Ethernet del dispositivo.

Para configurar el dispositivo a fin de transmitir directamente:

- 1 Seleccione la opción **DHCP** en los ajustes de red.
- 2 Configure el equipo informático para compartir la conexión a Internet mediante el puerto Ethernet.

Mac: Haga clic en **Compartir** en las Preferencias del Sistema y seleccione **Compartir Internet** en la lista de servicios. En el menú **Compartir conexión desde**, seleccione **WiFi** si el equipo informático se encuentra conectado a la red de manera inalámbrica. En la lista disponible, seleccione la opción **Ethernet**. En la lista **Servicio**, marque la casilla **Compartir Internet**. Haga clic en **Comenzar** cuando el sistema le pregunte si desea activar esta opción.

Windows: Haga clic con el botón derecho en el ícono de inicio y seleccione la opción **Conexiones de red**. Se abrirá una ventana que muestra el estado de la red. Haga clic en **Cambiar opciones de adaptador**. Verá una lista con todas las conexiones de red. Haga clic con el botón derecho en la conexión de Internet y seleccione **Propiedades**. En la pestaña **Compartir**, marque la opción **Permitir a otros usuarios de red conectarse a Internet a través de este equipo**. Seleccione una conexión de red en el menú y haga clic en **Aceptar**.

- 3 Conecte el dispositivo al puerto Ethernet del equipo informático. Una vez transcurridos algunos segundos, se le asignará una dirección IP mediante el protocolo DHCP.
- 4 Confirme que el dispositivo está conectado a Internet mediante el ícono que aparece en la esquina superior izquierda de la pantalla de la unidad.

Transmisión mediante teléfonos móviles

Es posible anclar el dispositivo a un teléfono móvil para transmitir desde cualquiera que cuente con cobertura de red.

Para compartir la conexión del teléfono móvil:

- 1 Conecte el dispositivo al teléfono mediante un cable USB-C y el puerto correspondiente en el panel delantero o trasero de la unidad.
- 2 Active la opción para compartir la conexión a Internet del teléfono.

En dispositivos con sistema iOS, asegúrese de que la opción **Permitir que otros se conecten** esté activada en el menú correspondiente de los ajustes para el punto de acceso personal. En dispositivos con sistema Android, deslice el dedo hacia abajo sobre la pantalla a fin de acceder al menú rápido. Mantenga pulsado el ícono **Compartir conexión** y active el anclaje mediante la conexión USB.

A continuación, presione el botón **ON AIR** en el dispositivo para transmitir la señal en directo.

SUGERENCIA: Recomendamos desactivar dichos ajustes una vez terminada la transmisión, a fin de extender la duración de la batería del teléfono.

Si hay un cable de red conectado al dispositivo, recomendamos comprobar que este último se encuentre configurado para compartir la conexión del teléfono móvil. Abra el programa utilitario Web Presenter Setup y acceda a la ventana **Setup**. A continuación, en la sección **Network**, seleccione **Mobile** en la opción **Connection Priority**.

Uso del dispositivo como cámara web

Los programas como Skype y Zoom reconocen automáticamente el dispositivo como una cámara web, de modo que, al ejecutarlos, es posible ver de inmediato la señal transmitida por este. Si esto no sucede, elija la unidad en la lista de opciones para la cámara y el micrófono.

A continuación, se proporciona un ejemplo de cómo seleccionar el dispositivo en Skype.

- 1 En la barra de menú del programa, seleccione **Configuración de audio y video**.
- 2 Haga clic en el menú desplegable **Cámara** y seleccione el dispositivo en la lista que aparece. La señal transmitida por el mismo aparecerá en la ventana de vista previa.
- 3 Seleccione el dispositivo como fuente de audio en el menú desplegable **Micrófono**.

Configuración de Open Broadcaster

Open Broadcaster es un programa de código abierto que facilita la transmisión de señales desde el dispositivo mediante diversas plataformas, tales como YouTube, Twitch, Facebook Live, entre otras. El programa comprime el material con el propósito de lograr una velocidad de transmisión adecuada para la plataforma elegida.

A continuación, se incluye un ejemplo que muestra cómo configurar Open Broadcaster para transmitir la señal desde el dispositivo mediante YouTube Live.

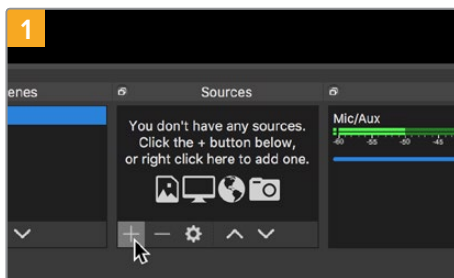

Ejecute Open Broadcaster y haga clic en el símbolo +, en el recuadro Sources.

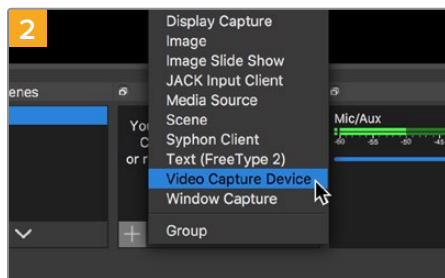

Seleccione la opción Video Capture Device.

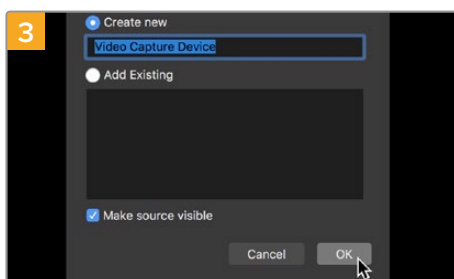

Asigne un nombre a la fuente y haga clic en OK.

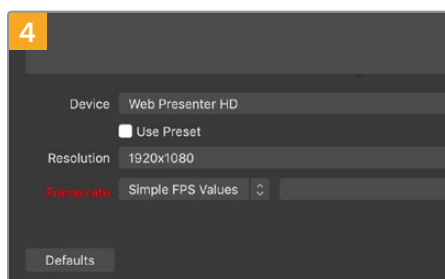

En el menú Device, seleccione el dispositivo y haga clic en OK.

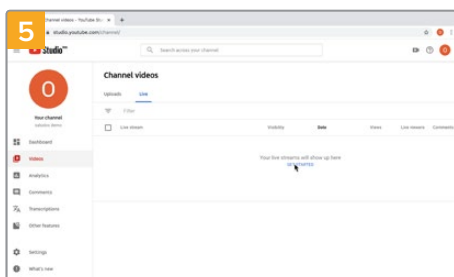

A continuación, acceda a su cuenta de YouTube. Haga clic en el botón Transmitir en vivo, y luego en la opción Transmitir.

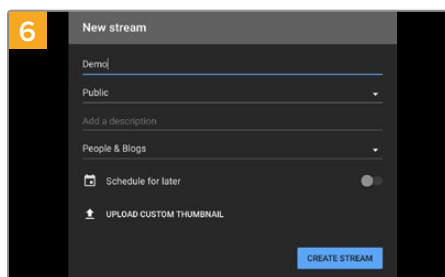

En las opciones de transmisión, introduzca la información correspondiente y haga clic en Crear transmisión.

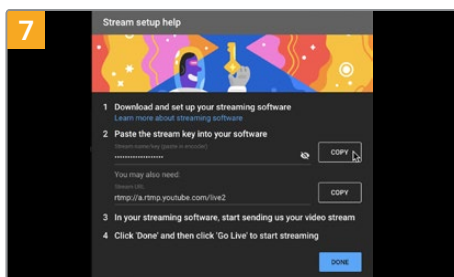

YouTube generará una clave para la transmisión que vincula Open Broadcaster con su cuenta. Haga clic en el botón COPIAR junto a la clave de transmisión y péguela en Open Broadcaster.

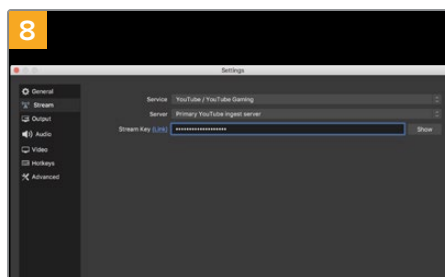

En Open Broadcaster, haga clic en el menú OBS/Preferences en la barra superior para acceder a las preferencias del programa. Seleccione la opción Stream. Pegue la clave de transmisión copiada y haga clic en OK. A continuación, verá la señal transmitida por el dispositivo en la ventana de vista previa del programa.

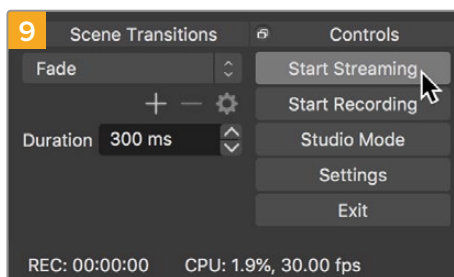

Para vincular el enlace de transmisión de Open Broadcaster con YouTube, haga clic en la opción **Start Streaming**, situada en la esquina superior derecha de la pantalla. Una vez que se establece la conexión entre ambas aplicaciones, el resto se configura desde YouTube Live.

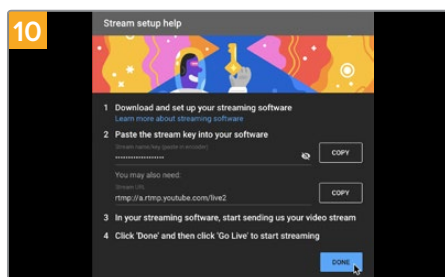

La señal transmitida mediante la salida USB del dispositivo se verá en YouTube Live. Haga clic en **Listo**.

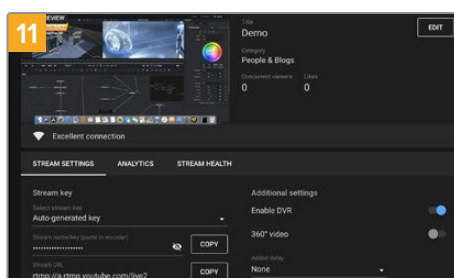

Una vez que Open Broadcaster y YouTube Live están comunicados, es posible iniciar la transmisión. Asegúrese de que todo esté funcionando correctamente.

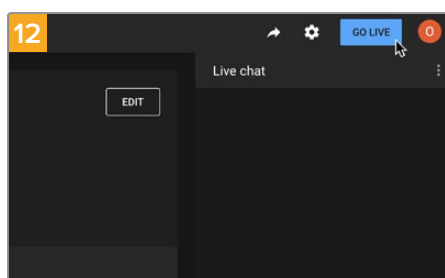

Si está todo listo, haga clic en la opción **TRANSMITIR EN VIVO**.

Ya está transmitiendo en directo por YouTube mediante el programa Open Broadcaster.

NOTA: Debido a que se trata de una transmisión por Internet, es posible que haya cierto retraso. Por lo tanto, es importante mirarla por YouTube y confirmar que haya finalizado antes de hacer clic en el botón **End Stream** para evitar interrumpir accidentalmente la señal.

Creación de enlaces con el modelo ATEM Streaming Bridge

Este conversor permite decodificar la señal proveniente del dispositivo para obtener otra en formato SDI o HDMI que puede transmitirse mediante una red local o a cualquier lugar del mundo a través de Internet.

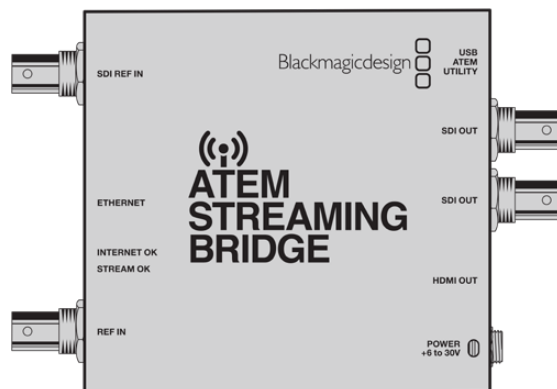

Si el conversor y el dispositivo están conectados a la misma red local, el primero aparecerá en la lista de opciones del menú **Plataform**, en la pestaña **Live Stream** del programa Web Presenter Setup.

De lo contrario, es posible importar un archivo XML con ajustes desde un equipo informático o una unidad USB conectada al dispositivo.

Un buen ejemplo de cómo el dispositivo funciona con el conversor ATEM Streaming Bridge es la transmisión de un informe meteorológico desde exteriores a un estudio. A tales efectos, solo es necesario contar con una conexión a Internet a través de una red o un teléfono móvil.

En el estudio, el conversor recibe la señal transmitida mediante Internet y la convierte para obtener otra en formato SDI, a fin de poder conectar un mezclador.

En este caso, la dinámica de trabajo sería la siguiente

- 1 En exteriores, el dispositivo Blackmagic Web Presenter se conecta a la salida SDI principal de un mezclador, por ejemplo, el modelo ATEM Constellation 8K.
- 2 A continuación, el dispositivo se conecta a un teléfono móvil.
- 3 En el estudio, el conversor ATEM Streaming Bridge también se conecta a Internet mediante una red Ethernet.
- 4 El conversor recibe la señal a través de Internet y la convierte para obtener otra en formato SDI que se transmite a la entrada SDI del mezclador para emitirla al aire.

A fin de que el conversor pueda recibir la señal transmitida, es preciso ejecutar el programa utilitario ATEM Setup y configurar los ajustes de Internet. Esto incluye generar un archivo XML con los ajustes de la transmisión para cargarlo en la unidad que se encuentra en exteriores.

Crear el archivo XML

Para crear un archivo XML con los ajustes, conecte un cable de red del puerto Ethernet del dispositivo ATEM Streaming Bridge a un enrutador o un conmutador de red.

Conecte el dispositivo al equipo informático mediante un cable USB-C y ejecute el programa ATEM Setup.

En la pestaña **Setup**, compruebe que la configuración de la red sea correcta y seleccione **Internet** en la opción **Stream Service**. Aparecerá el siguiente mensaje en el recuadro correspondiente al estado de Internet: **Visible worldwide**. Esto significa que todo se encuentra funcionando correctamente.

Nota sobre el redireccionamiento de puertos:

Si en el recuadro mencionado anteriormente aparece un mensaje de error UPnP o relativo al redireccionamiento del puerto, consulte al administrador de red o al proveedor de servicios de Internet cómo cambiar dicho parámetro a **TCP port 1935**.

Exportar el archivo XML

Después de confirmar los ajustes en la pestaña **Setup** y conectar correctamente el dispositivo ATEM Streaming Bridge a Internet o la red, es posible exportar el archivo XML.

- 1 Haga clic en la pestaña **ATEM Mini Pro**, en la esquina superior derecha de la ventana.

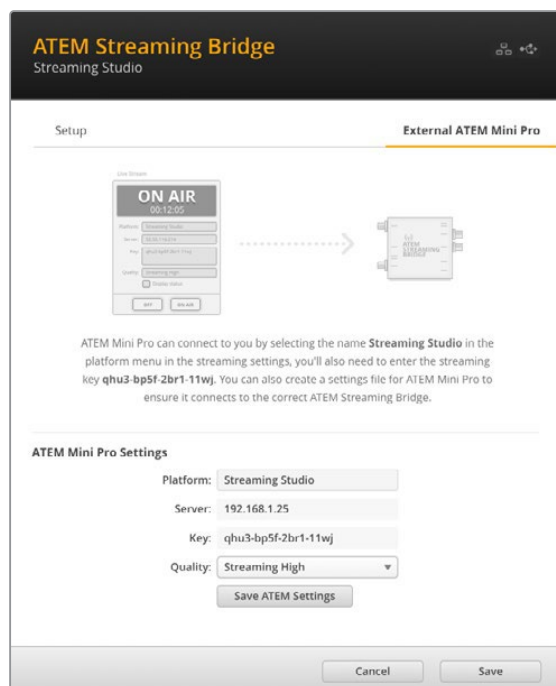

- 2 Para asignar un nombre a la plataforma, haga clic en la opción **Platform** e introduzca el nombre deseado. Dicho nombre aparecerá en el menú de plataformas de la unidad Blackmagic remota.
- 3 Seleccione la calidad deseada para la transmisión. Este ajuste se refiere a la unidad Web Presenter conectada en forma remota.
- 4 Haga clic en el botón **Save ATEM Settings**, elija una ubicación en el equipo informático para guardar el archivo XML y haga clic en **Guardar**.
- 5 Ahora es posible enviar el archivo XML guardado al operador por correo electrónico.

SUGERENCIA: Mediante los ajustes de comunicación en el programa ATEM Setup, es posible seleccionar los canales de audio que se desean transmitir a la unidad Web Presenter remota.

Cargar el archivo XML

With the settings file emailed to the location, the location crew simply loads the XML into the Web Presenter using Blackmagic Web Presenter setup, then presses on air to start streaming the weather report to the studio!

It's important to mention that once you have loaded the streaming XML file, you can then start and stop streaming without ever having to load it again. This makes it easy to set up a constant video link between the Web Presenter and the ATEM Streaming Bridge.

As long as the ATEM Streaming Bridge at the studio hasn't changed the streaming and network settings and is still looking for that Web Presenter, it will always find it no matter where it is on the internet. At any location, you can simply plug your Web Presenter into the internet, press 'on air', and it will immediately be streaming to the ATEM Streaming Bridge back at the studio.

You can find more details on how to use ATEM Streaming Bridge in the ATEM Mini manual which can be downloaded at www.blackmagicdesign.com/support

Luz piloto, comunicación y control de cámaras

Los dispositivos ATEM Streaming Bridge y Web Presenter pueden recibir información transmitida desde un mezclador para activar la luz piloto, establecer la comunicación y controlar las cámaras.

De esta forma, es posible trabajar con cámaras SDI de Blackmagic Design desde cualquier lugar del mundo, siempre que tengan acceso a Internet o a la red local para poder hacer uso de dichas funciones.

La configuración es muy simple. La siguiente ilustración muestra cómo conectar el modelo URSA Mini Pro 4.6K a un mezclador ATEM Constellation 8K mediante una red local para activar la luz piloto, establecer la comunicación y controlar las cámaras.

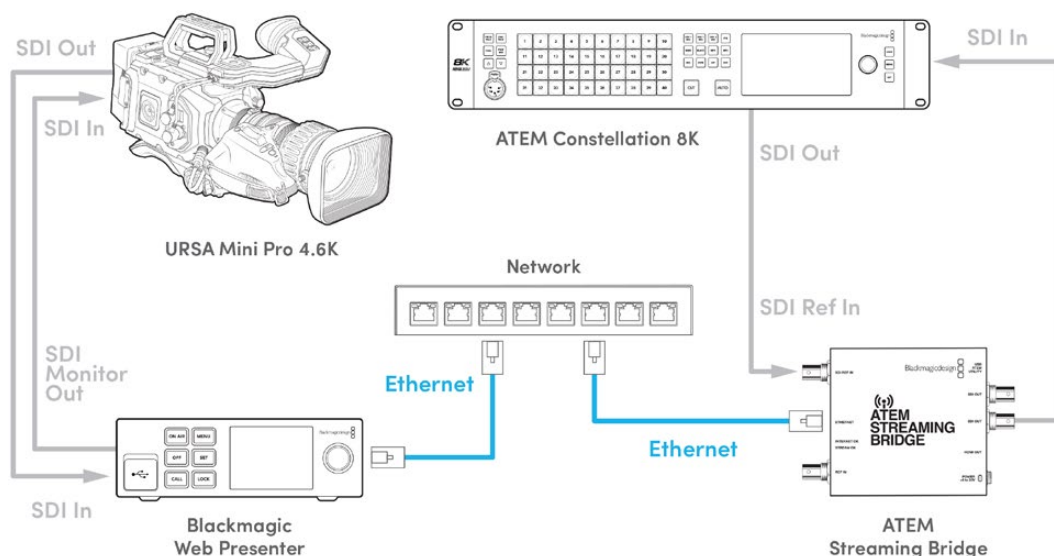

Después de conectar todos los equipos:

- 1 Presione el botón **MENÚ** en el dispositivo Blackmagic Web Presenter para acceder al menú en la pantalla y seleccione la opción **Transmisión en directo**.
- 2 Seleccione el dispositivo ATEM Streaming Bridge en la opción **Plataforma**.
- 3 Presione el botón **SET** para confirmar.

Para que la luz piloto funcione, es necesario verificar que el número identificador de la cámara coincida con el de la entrada en el mezclador. Consulte el manual del modelo URSA Mini a fin de obtener más información al respecto.

Para comprobar que la luz piloto funcione adecuadamente, seleccione la cámara como fuente para la salida principal del mezclador. Si el número identificador de la unidad es correcto, la luz piloto se encenderá, y aparecerá un borde rojo en la pantalla de la cámara. Al seleccionar la señal de la cámara como anticipo, la luz piloto se encenderá de verde.

Intente ajustar la apertura del diafragma y el pedestal en la pestaña **Cámara** del programa ATEM Software Control para verificar que pueda controlar la unidad.

Por defecto, la comunicación se establece a través de los canales de audio 15 y 16, pero es posible seleccionar los canales 13 y 14, destinados a los ingenieros, o la salida principal mediante el programa utilitario ATEM Setup.

Al transmitir por Internet, se crea un archivo XML mediante el programa utilitario ATEM Setup.

Luego, dicho archivo se carga en el dispositivo Blackmagic Web Presenter para que este detecte la unidad ATEM Streaming Bridge en la red. Consulte el apartado anterior en este manual para obtener más información al respecto.

Conexión del modelo URSA Broadcast G2

Este modelo puede transmitir la señal directamente a través del puerto USB-C, de modo que no es necesario utilizar un dispositivo Blackmagic Web Presenter. Consulte el manual de la cámara para obtener más información al respecto.

Blackmagic Universal Rack Shelf

Este accesorio es un estante de 1 U que permite instalar una amplia gama de dispositivos de Blackmagic Design en bastidores o cajas de transporte. Su diseño modular brinda la posibilidad de crear sistemas portátiles y prácticos con productos que comparten una misma unidad de bastidor.

La siguiente imagen muestra tres estantes Blackmagic Universal Rack Shelf instalados en un bastidor con distintas unidades compatibles. El estante inferior incluye una placa ciega de 1/3 U, a fin de rellenar el espacio vacío entre los distintos dispositivos.

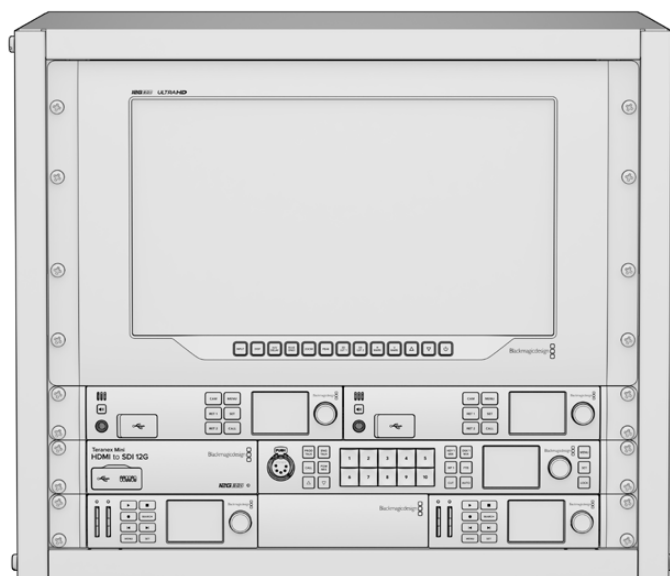

Índice

El kit de instalación incluye los siguientes componentes:



1 x Blackmagic Universal Rack Shelf

Un estante de 1 U que permite instalar equipos de Blackmagic Design.

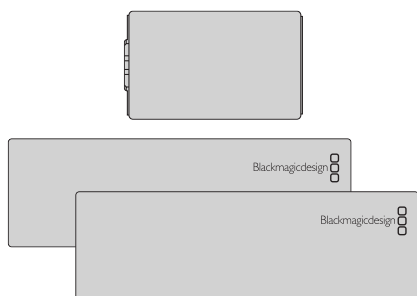

Placas ciegas

Una placa de 1/6 U y dos de 1/3 U que permiten cubrir los espacios vacíos en el estante.

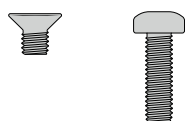

Tornillos

12 tornillos M3 (5 mm) avellanados.

2 tornillos M3 (9 mm) de cabeza plana para las placas ciegas de 1/6 U.

Instalación de una unidad en el estante

- 1 Si el dispositivo cuenta con pies de goma, retírelos de la base de la unidad con un raspador de plástico.
- 2 Gire el estante y la unidad de manera que la parte inferior mire hacia arriba y haga coincidir los agujeros del estante con los orificios roscados del dispositivo de Blackmagic Design. Hay dos orificios roscados centrales en las unidades de 1/3 U y hasta tres orificios en las más grandes de 1/2 U.

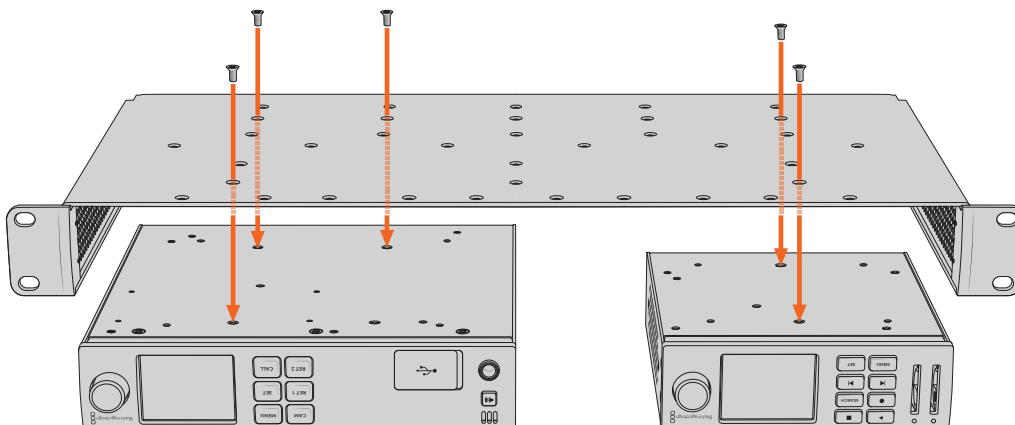

- 3 Instale el dispositivo en el bastidor mediante los tornillos M3 (5 mm) avellanados que se suministran.
- 4 Una vez que estén ajustados, invierta nuevamente el estante y colóquelo en el bastidor con las escuadras integradas.

Es posible utilizar las placas ciegas provistas para cubrir el espacio vacío.

Instalación de la placa ciega de 1/6

Es posible utilizar la placa ciega de 1/6 U para rellenar el espacio vacío al instalar unidades de 1/2 y 1/3 U. La placa se puede adosar a los laterales de las unidades. A fin de mejorar la ventilación, se recomienda montar el panel entre los dispositivos.

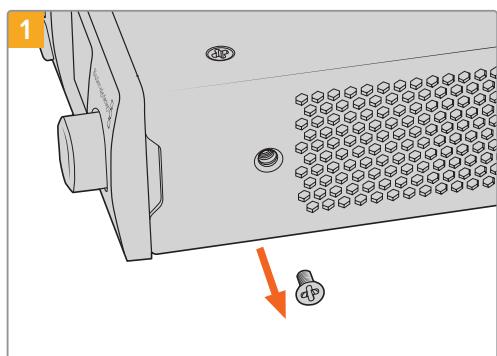

1 Quite el tornillo M3 (5 mm) ubicado cerca de la parte delantera del dispositivo.

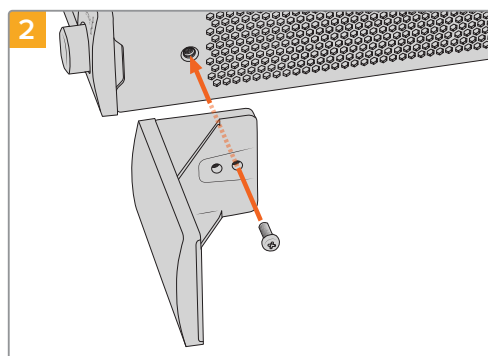

2 Haga coincidir los agujeros de la placa ciega y sujétela mediante el tornillo M3 (9 mm) suministrado.

Instalación de la placa ciega de 1/3

Es posible instalar las placas ciegas de 1/3 U directamente en los laterales del estante al montar unidades individuales. Para colocar una placa ciega, los orificios y el punto de fijación en la base de la placa deben estar alineados con el estante, y es necesario utilizar dos tornillos M3 (5 mm) avellanados para sujetarla.

Actualización del dispositivo

El programa utilitario permite actualizar el sistema operativo interno del dispositivo, configurar los ajustes de red, seleccionar distintos parámetros para la transmisión y determinar la calidad de las imágenes.

Para actualizar el dispositivo:

- 1 Descargue el instalador Blackmagic Web Presenter desde nuestro sitio web.
- 2 Ejecute el instalador y siga las instrucciones que aparecen en la pantalla.
- 3 Una vez finalizada la instalación, conecte el dispositivo a un equipo informático mediante el puerto USB situado en el panel trasero o delantero, bajo la cubierta protectora.
- 4 Ejecute el programa Blackmagic Web Presenter Setup y siga las instrucciones que aparecen en la pantalla para actualizar el sistema operativo interno. Si no aparece ningún aviso, el procedimiento ha concluido exitosamente.

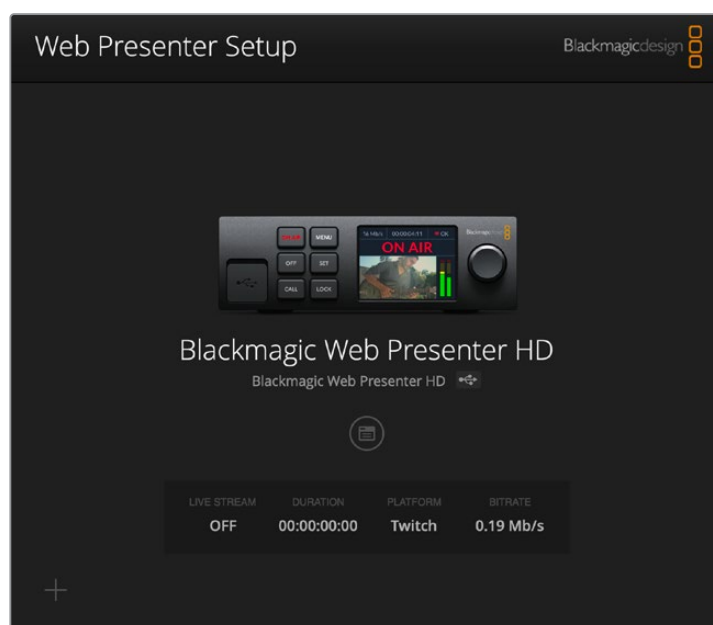

Después de comprobar la versión del programa instalada en el equipo informático, visite nuestro centro de soporte técnico para verificar si existen actualizaciones disponibles.

Developer Information

Blackmagic Web Presenter Ethernet Protocol

v1.2

Protocol Details

Overview

The Blackmagic Web Presenter Ethernet Protocol is a line-oriented, text-based protocol to control a Web Presenter.

Lines from the Web Presenter server will be separated by an ASCII LF sequence.

Messages from the user may be separated by LF or CR LF.

Connection

The Web Presenter server is accessed by connecting to TCP port 9977 on a Web Presenter.

Connection Response

Upon connection, the Web Presenter server sends a dump of the device's state.

The Web Presenter server sends information in blocks, with each having an identifying header followed by a colon. A block spans multiple lines and is terminated by a blank line. Each line in the protocol is terminated by a newline character.

Following the header, a block contains either a single multi-line string or a sequence of key/value pairs arranged one per line. The first full-colon on a line is used to delimit the key and the value. A value may be a comma separated list. In this case, values in the list must have the “,” and “\” characters escaped with a “\” character.

To be resilient to future protocol changes, clients should ignore blocks they do not recognize, up to the trailing blank line. Within recognized blocks, clients should ignore keys they do not recognize.

Legend	
↵	End of line
...	and so on
Orange Text	Client Generated
Grey Text	Server Generated

The protocol preamble block is always the first block sent by the Web Presenter server:

```
PROTOCOL PREAMBLE:↵
Version: 1.2↵
↵
```

The version field indicates the protocol version. When the protocol is changed in a compatible way, the minor version number will be updated. If incompatible changes are made, the major version number will be updated.

The initial status dump is concluded by the end prelude block:

```
END PRELUDE:↵
↵
```

Status Updates

When any device parameter is changed on the Web Presenter server by any client, such as the Blackmagic Web Presenter Setup utility, the Web Presenter server resends the applicable status block, containing only the items that have changed. Status updates can also occur due to external changes such as tethering to a smartphone or when a streaming service is disconnected.

For example, if the input video mode is set to Auto, the following block will be sent:

```
STREAM SETTINGS:↵  
Video Mode: Auto↵  
↵
```

Requesting Changes

To change one or more parameters in a block, the client should send the appropriate block header in the same form the Web Presenter server sends, followed by the key/value pairs to be changed. For example, to change the input video format to 1080p59.94, the user should send the following block:

```
STREAM SETTINGS:↵  
Video Mode: 1080p59.94↵  
↵
```

The block must be terminated by a blank line. On receipt of a blank line, the Web Presenter server will either acknowledge the request by responding:

```
ACK↵  
↵
```

or if unable to parse the block responding with:

```
NACK↵  
↵
```

After a positive response, the client should expect to see a status update from the Web Presenter server showing the status change. This is likely to be the same as the command that was sent, sometimes followed by other blocks providing data specific to the change.

```
STREAM SETTINGS:↵  
Video Mode: 1080p59.94↵  
↵
```

If the Web Presenter server does not understand a key in the requested block, the key will be ignored. If an invalid value is provided for a known key, then the request is ignored and the Web Presenter will respond with the existing value for the key. In both cases the Web Presenter server will still respond with an ACK.

```
STREAM SETTINGS:↵  
Video Mode: UnsupportedMode↵  
↵  
ACK↵  
↵  
STREAM SETTINGS:↵  
Video Mode: 1080p59.94↵  
↵
```

Requesting a Status Dump

The user may request that the Web Presenter server resend the complete state of any status block by sending the block header, followed by a blank line. In the following example, the user requests the Web Presenter server resend the stream settings:

```
STREAM SETTINGS:↵
↵
ACK↵
↵
STREAM SETTINGS:↵
Video Mode: 1080p59.94↵
...
↵
```

Protocol Blocks

Identity Block

The identity block contains information to identify the connected Web Presenter.

Block Syntax

The following example shows the Identity Block for a Blackmagic Web Presenter HD.

```
IDENTITY:↵
Model: Blackmagic Web Presenter HD↵
Label: Blackmagic Web Presenter HD↵
Unique ID: 00112233445566778899AABBCCDDEEFF↵
↵
```

Parameters

Key	Read/Write	Description	Valid Values
Model	Read only	The Web Presenter model name	String
Label	Read/Write	A display name for the Web Presenter	String
Unique ID	Read only	A device specific unique identifier	Hexadecimal ID

Changing Device Label

A device label to identify the Web Presenter can be changed by sending an identity block with label key.

```
IDENTITY:↵
Label: My Web Presenter↵
↵
ACK↵
↵
IDENTITY:↵
Label: My Web Presenter↵
↵
```

Version Block

The version block contains hardware and software version information for the connected Web Presenter.

Block Syntax

```
VERSION:↵  
Product ID: BE73↵  
Hardware Version: 0100↵  
Software Version: 0123ABCD↵  
Software Release: 3.3↵  
↵
```

Parameters

Key	Read/Write	Description	Valid Values
Product ID	Read only	The Web Presenter product ID	Hexadecimal ID
Hardware Version	Read only	The Web Presenter hardware version	Hexadecimal version
Software Version	Read only	The Web Presenter software version	Hexadecimal version
Software Release	Read only	The Web Presenter software release version	Version Number

Network Blocks

The network block contains the TCP/IP networking configuration for the connected Web Presenter.

Block Syntax

This example shows the output for a connected Web Presenter. It displays 2 networking interfaces - the Gigabit Ethernet interface and option for a tethered smartphone.

The network settings prefixed with Current show the active TCP/IP settings, and are read-only. The Current settings reflect either the DHCP or Static configuration, depending on the Dynamic IP flag.

```
NETWORK:↵  
Interface Count: 2↵  
Default Interface: 0↵  
↵  
NETWORK INTERFACE 0:↵  
Name: Ethernet↵  
Priority: 1↵  
MAC Address: 00:11:22:33:44:55↵  
Dynamic IP: true↵  
Current Addresses: 192.168.1.10/255.255.255.0↵  
Current Gateway: 192.168.1.1↵  
Current DNS Servers: 192.168.1.1, 8.8.8.8, 8.8.4.4↵  
Static Addresses: 10.0.0.2/255.255.255.0↵  
Static Gateway: 10.0.0.1↵  
Static DNS Servers: 8.8.8.8, 8.8.4.4↵  
↵
```

```

NETWORK INTERFACE 1:↵
Name: USBEthernet↵
Priority: 0↵
MAC Address: 00:00:00:00:00:00↵
Dynamic IP: true↵
Current Addresses: 0.0.0.0/255.255.0.0↵
Current Gateway: 0.0.0.0↵
Current DNS Servers: ↵
Static Addresses: 10.0.0.2/255.255.255.0↵
Static Gateway: 10.0.0.1↵
Static DNS Servers: 8.8.8.8, 8.8.4.4↵
↵

```

Parameters

Network Block

Key	Read/Write	Description	Valid Values
Interface Count	Read only	The number of networking interfaces supported by the Web Presenter	Integer
Default Interface	Read only	The default networking interface	Integer

Network Interface Block

Key	Read/Write	Description	Valid Values
Name	Read only	The name of the networking interface	String
Priority	Read/Write	The priority of the network interface. When multiple network interfaces are available, the high priority interface will become the default	Unsigned integer. The higher number is the higher priority
MAC Address	Read Only	MAC address of the networking interface	IEEE 802 MAC address
Dynamic IP	Read/Write	Selects DHCP or Static IP configuration	true - DHCP enabled false - Static IP
Current Addresses	Read Only	The current IP address and Subnet mask	{IPv4 address}/{Subnet Mask}
Current Gateway	Read Only	The current IP gateway address	IPv4 address
Current DNS Servers	Read only	The IP addresses of the current DNS servers	Comma separated list of IPv4 addresses
Static Addresses	Read/Write	Status IP address and subnet mask when DHCP disabled	{IPv4 address}/{Subnet Mask}
Static Gateway	Read/Write	Static gateway address when DHCP disabled	IPv4 address
Static DNS Servers	Read/Write	The IP addresses of the static DNS servers	Comma separated list of IPv4 addresses

Changing Networking Settings

The network can be configured to use either DHCP or a static configuration. To enable DHCP on Network Interface 0:

```
NETWORK INTERFACE 0:↵
```

```
Dynamic IP: true↵
```

```
↵
```

```
ACK↵
```

```
↵
```

```
NETWORK INTERFACE 0:↵
```

```
Dynamic IP: true↵
```

```
↵
```

To set a fixed IP address, supply all static parameters:

```
NETWORK INTERFACE 0:↵
```

```
Dynamic IP: false↵
```

```
Static Addresses: 192.168.1.2/255.255.255.0↵
```

```
Static Gateway: 192.168.1.1↵
```

```
Static DNS Servers: 8.8.8.8, 8.8.4.4↵
```

```
↵
```

```
ACK↵
```

```
↵
```

```
NETWORK INTERFACE 0:↵
```

```
Dynamic IP: false↵
```

```
Static Addresses: 192.168.1.2/255.255.255.0↵
```

```
Static Gateway: 192.168.1.1↵
```

```
Static DNS Servers: 8.8.8.8, 8.8.4.4↵
```

```
↵
```

Changing network settings may cause the IP connection to be dropped.

UI Settings Block

The UI settings block contains the front panel LCD and monitor output settings for the connected Web Presenter.

Block Syntax

```
UI SETTINGS:↵
```

```
Available Locales: en_US.UTF-8, zh_CN.UTF-8, ja_JP.UTF-8, ko_KR.UTF-8, es_
ES.UTF-8, de_DE.UTF-8, fr_FR.UTF-8, ru_RU.UTF-8, it_IT.UTF-8, pt_BR.UTF-8,
tr_TR.UTF-8, pl_PL.UTF-8, uk_UA.UTF-8↵
```

```
Current Locale: en_US.UTF-8↵
```

```
Available Audio Meters: PPM -18dB, PPM -20dB, VU -18dB, VU -20dB↵
```

```
Current Audio Meter: PPM -20dB↵
```

```
↵
```

Parameters

Key	Read/Write	Description	Valid Values
Available Locales	Read only	The locales available in the Web Presenter	Comma separated list of locales
Current Locale	Read/Write	The current locale for Web Presenter	Refer to the locales from the Available Locales field
Available Audio Meters	Read only	The available audio meters supported by the Web Presenter	Comma separated list of audio meter types
Current Audio Meter	Read/Write	The current audio meter	Refer to the audio meters from the Available Audio Meters field

Stream Settings Block

The stream settings block contains the stream configuration for the connected Web Presenter.

Block syntax

This example shows the output for a connected Web Presenter. The stream settings prefixed with Current show the active stream settings and are writable. The stream settings prefixed by Available show the available stream settings for the device or platform and are read-only. To view the available servers or quality levels for a stream service, the Current Platform stream setting should be set first.

```
STREAM SETTINGS:↵
Available Video Modes: Auto, 1080p23.98, 1080p24, 1080p25, 1080p29.97,
1080p30, 1080p50, 1080p59.94, 1080p60, 720p25, 720p30, 720p50, 720p60↵
Video Mode: 1080p59.94↵
Current Platform: YouTube↵
Current Server: Primary↵
Current Quality Level: Streaming Medium↵
Stream Key: abc1-def2-ghi3-jkl4-mno5↵
Password: ↵
Current URL: srt://192.168.8.51
Customizable URL: true
Available Default Platforms: YouTube RTMP, YouTube SRT (Beta), Facebook,
Twitch, Twitter, Restream.IO, Vimeo, BoxCast, CastR, AfreecaTV, Bilibili,
DouYu, Weibo↵
Available Custom Platforms: My Platform↵
Available Servers: Primary, Secondary↵
Available Quality Levels: HyperDeck High, HyperDeck Medium, HyperDeck Low,
Streaming High, Streaming Medium, Streaming Low↵
↵
```

Parameters

Key	Read/Write	Description	Valid Values
Available Video Modes	Read only	The video modes available in the Web Presenter	Comma separated list of video modes
Video Mode	Read/Write	The current video mode	Refer to the video modes from the <i>Available Video Modes</i> field
Current Platform	Read/Write	The selected streaming platform	Refer to the platforms from the <i>Available Default Platforms</i> and <i>Available Custom Platforms</i> fields
Current Server	Read/Write	The current server for the streaming platform	Server is dependent on selected Current Platform
Current Quality Level	Read/Write	The current streaming quality level	Quality level is dependent on selected Current Platform
Stream Key	Read/Write	The stream key for the streaming platform	String
Password	Read/Write	The passphrase for an encrypted SRT stream	String
Current URL	Read/Write	The current URL for the streaming platform. This field is writable if <i>Customizable URL</i> field is true.	String
Customizable URL	Read only	A boolean specifying whether custom URLs are supported by the streaming platform	true - Custom URLs are supported false - Custom URLs are not supported
Available Default Platforms	Read only	The available default streaming platforms	Comma separated list of default platforms
Available Custom Platforms	Read only	The custom streaming platforms loaded in the Web Presenter	Comma separated list of custom platforms
Available Servers	Read only	The available servers for the selected streaming platform	Comma separated list of servers
Available Quality Levels	Read only	The available quality levels for the selected streaming platform	Comma separated list of quality levels

Changing Stream Settings

The stream settings can be changed by providing a stream settings block. The following is an example of streaming a 1080p59.94 input on Twitch with a medium stream quality.

```

STREAM SETTINGS:↵
Video Mode: 1080p59.94↵
Current Platform: Twitch↵
Current Server: US West: Los Angeles, CA↵
Current Quality Level: Streaming Medium↵
Stream Key: live_123456789_1aB2cD3eF4gH5iJ6kL7mN8oP9qR0sT↵
↵
ACK↵
↵
STREAM SETTINGS:↵
Video Mode: 1080p59.94↵
Current Platform: Twitch↵
Current Server: US West: Los Angeles, CA↵
Current Quality Level: Streaming Medium↵
Stream Key: live_123456789_1aB2cD3eF4gH5iJ6kL7mN8oP9qR0sT↵
↵

```

Stream XML Block

The stream XML block allows users to configure the Web Presenter with a custom configuration file in XML format.

Block syntax

The following example shows an XML file - Custom.xml has been loaded to configure the stream settings in the Web Presenter.

```
STREAM XML:↵  
Files: Custom.xml↵  
↵
```

Parameters

Key	Read/Write	Description	Valid Values
Files	Read/Write	The XML files loaded in Web Presenter	Comma separated list of filenames
Action	Write only	The stream XML action	Remove Remove All

Adding a Stream XML file

An XML file can be loaded onto a Web Presenter by sending the stream xml command with a filename, then provide the contents of the XML file. After adding the XML file, the Available Custom Platforms field in the STREAM SETTINGS block will be updated with the new platforms, however the Current items will remain unchanged.

For the Stream XML block to be parsed correctly, any blank lines should be removed from the XML files.

Refer to the `Blackmagic Stream XML File Format` section in this manual for description of the Stream XML file format.

```
STREAM XML Custom.xml:↵  
<?xml version="1.0" encoding="UTF-8"?>↵  
<streaming>↵  
    <service>↵  
        <name>My Custom Platform</name>↵  
        ...  
    </service>↵  
</streaming>↵  
↵  
ACK↵  
↵  
STREAM XML Custom.xml:↵  
<?xml version="1.0" encoding="UTF-8"?>↵  
<streaming>↵  
    <service>↵  
        <name>My Custom Platform</name>↵  
        ...  
    </service>↵  
</streaming>↵  
↵
```

```
STREAM XML:↵
Files: Custom.xml↵
↵
STREAM SETTINGS:↵
Available Custom Platforms: My Custom Platform↵
↵
```

Removing a Stream XML file

An XML file can be removed from the Web Presenter by sending the stream xml command with the remove action.

```
STREAM XML:↵
Action: Remove↵
Files: Custom.xml↵
↵
ACK↵
↵
STREAM XML:↵
Files:↵
↵
STREAM SETTINGS:↵
Available Custom Platforms:↵
↵
```

Removing all Stream XML files

All XML files can be removed from the Web Presenter by sending the stream xml command with the remove all action. In the example, following the remove all action, the loaded stream XML files and available custom platforms are both displayed as empty.

```
STREAM XML:↵
Action: Remove All↵
↵
ACK↵
↵
STREAM XML:↵
Files: ↵
↵
STREAM SETTINGS:↵
Available Custom Platforms:↵
↵
```

Stream State Block

The stream state block provides the streaming status of the Web Presenter.

The Web Presenter server will send a stream state block update whenever there is a change to the Status field. Due to frequency of changes to Duration, Bitrate and Cache Used fields, these fields need to be polled by the client by requesting a Stream State block.

Block syntax

```
STREAM STATE:↵↵
Status: Idle↵↵
Bitrate: 161672↵↵
Duration: 00:00:00:00↵↵
Cache Used: 0↵↵
↵↵
```

Parameters

Key	Read/Write	Description	Valid Values
Status	Read only	The stream state of the Web Presenter, updated when the stream status changes	Idle Connecting Streaming Interrupted
Action	Write only	The Web Presenter stream state action.	Start Stop
Duration	Read only	The duration of the active stream	String in format of DD:HH:MM:SS
Bitrate	Read only	The bitrate of the active stream	Integer bits per second
Cache Used	Read only	The current usage of the streaming cache	Integer as a percentage

Starting Stream

The stream is started by providing a stream state block with start action.

```
STREAM STATE:↵↵
Action: Start↵↵
↵↵
ACK↵↵
↵↵
STREAM STATE:↵↵
Status: Connecting↵↵
↵↵
STREAM STATE:↵↵
Status: Streaming↵↵
↵↵
```

Stopping stream

The stream is stopped by providing a Stream State block with stop action.

```
STREAM STATE:↵↵
Action: Stop↵
↵
ACK↵
↵
STREAM STATE:↵↵
Status: Idle↵
↵
```

Audio Settings Block

The Audio Settings block contains the audio configuration for the connected Web Presenter.

Block syntax

This example shows the output for a connected Web Presenter. The stream settings prefixed with Current show the active audio settings and are writable. The stream settings prefixed by Available show the available audio settings for the device or platform and are read-only.

```
AUDIO SETTINGS:↵↵
Current Monitor Out Audio Source: Auto↵
Available Monitor Out Audio Sources: Auto, SDI In, Remote Source↵
↵
```

Parameters

Key	Read/Write	Description	Valid Values
Current Monitor Out Audio Source	Read/Write	The current audio source on the monitor output	Refer to the audio sources from the <i>Available Monitor Out Audio Sources</i> field
Available Monitor Out Audio Sources	Read only	The available audio sources that can be routed to the monitor output	Comma separated list of audio sources

Changing Audio Settings

The audio settings can be changed by providing an audio settings block. The following is an example of setting the monitor output audio source to remote.

```
AUDIO SETTINGS:↵↵
Current Monitor Out Audio Source: Remote Source↵
↵
ACK↵
↵
AUDIO SETTINGS:↵↵
Current Monitor Out Audio Source: Remote Source↵
↵
```

Shutdown Block

The Shutdown block provides power control of the Web Presenter. The Shutdown block is write-only and not presented in the preamble.

Parameters

Key	Read/Write	Description	Valid Values
Action	Write only	The Web Presenter shutdown action.	Reboot Factory Reset

Reboot

The Web Presenter can be rebooted by providing a Shutdown block with reboot action.

```
SHUTDOWN:↵
```

```
Action: Reboot↵
```

```
↵
```

```
ACK↵
```

```
↵
```

On reboot action, the Web Presenter server will be stopped and clients will be disconnected.

Factory Reset

The Web Presenter can be factory reset by providing a Shutdown block with factory reset action. On factory reset action, all settings are set to factory defaults.

```
SHUTDOWN:↵
```

```
Action: Factory Reset↵
```

```
↵
```

```
ACK↵
```

```
↵
```

Blackmagic Streaming XML Format

Overview

The Blackmagic Streaming XML allows users to specify streaming services in addition to the default services provided by the Web Presenter.

The Streaming XML can be loaded into the Web Presenter with Web Presenter Setup. Refer to the 'Using Web Presenter Setup' section earlier in this manual

The Streaming XML can also be loaded by copying the contents into the Stream XML block with the Blackmagic Web Presenter Ethernet Protocol.

The following is a minimal example of a Streaming XML file:

```
<?xml version="1.0" encoding="UTF-8"?>
<streaming>
  <service>
    <name>My Streaming Service</name>
    <servers>
      <server>
        <name>My Streaming Server</name>
        <url>rtmp://my.streaming-server.com/live</url>
      </server>
    </servers>
    <profiles>
      <profile>
        <name>My Streaming Quality</name>
        <config resolution="1080p" fps="60" codec="H264">
          <bitrate>7500000</bitrate>
        </config>
      </profile>
    </profiles>
  </service>
</streaming>
```

Streaming XML Definition

The Streaming XML file follows standard XML format and shall begin with XML declaration.

```
<?xml version="1.0" encoding="UTF-8"?>
```

Streaming Element

The Streaming XML file shall be contained by the <streaming> element. The <streaming> element will consist of 1 or more <service> child elements.

The following is an example of a <streaming> element block that defines 2 streaming services.

```
<streaming>
  <service>
    <name>Service 1</name>
    <!-- Streaming settings for "Service 1" -->
  </service>
  <service>
    <name>Service 2</name>
    <!-- Streaming settings for "Service 2" -->
  </service>
</streaming>
```

Service Element

The <service> element provides a description of the streaming service. If multiple streaming services are used, it is possible to define multiple <service> elements within each <streaming> element block.

The following is an example of a <service> element block in the Stream XML file.

```
<streaming>
  <service customizable-url="true">
    <name>My Streaming Service</name>
    <key>abc1-def2-ghi3-jkl4-mno5</key>
    <servers>
      <!-- Streaming server settings -->
    </servers>
    <profiles default="Streaming High">
      <!-- Streaming quality settings-->
    </profiles>
    <credentials>
      <!-- Streaming username and password settings -->
    </credentials>
  </service>
  <!-- <service> elements blocks for other streaming services -->
</streaming>
```

Attributes

Attribute	Optional/Required	Description
customizable-url	Optional	The service supports specifying custom URLs - supported = "true" or unsupported = "false" (default)

Child Elements

Element	Optional/Required	Description
<name>	Required	The name of the streaming service
<key>	Optional	The stream key for the streaming service
<servers>	Optional	The RTMP/SRT server settings of the streaming service (see below). May be omitted if customizable-url is true.
<profiles>	Required	The quality settings of the streaming service (see below)
<credentials>	Optional	The username and password of the streaming service (see below)

Servers Element

The <servers> element consists of 1 or more <server> child elements for defining the streaming server(s). The <servers> element is a required child of the <service> element. Defining multiple servers allows specifying localized and/or backup servers within a single XML description

The following is an example of a <servers> element block that defines a primary and secondary URL for the SRT server.

```
<service>
  ...
  <servers>
    <server group="Primary">
      <name>My Streaming Service Server</name>
      <url>srt://srt.my-streaming-service.com:2010</url>
      <srt-extensions>
        ...
      </srt-extensions>
    </server>
    <server group="Secondary">
      <name>My Streaming Service Backup Server</name>
      <url>srt://srt-backup.my-streaming-service.com:2010</url>
      <srt-extensions>
        ...
      </srt-extensions>
    </server>
    <!-- Additional <server> element blocks defining other
servers for streaming service -->
  </servers>
  ...
</service>
```

Attributes

Attribute	Optional/Required	Description
group	Optional	The logical grouping for the server

Child Elements

Element	Optional/Required	Description
<name>	Required	The name of the RTMP/SRT streaming server
<url>	Required	The URL of the RTMP/SRT streaming server
<srt-extensions>	Optional	Extended service block specific to SRT streaming server (see below)

SRT Extensions Element

The <srt-extensions> element consists of 1 or more child elements that define SRT specific parameters.

The following is an example of a <srt-extensions> element block for a primary stream identifier.

```
<service>
  ...
  <servers>
    <server group="Primary">
      ...
      <srt-extensions>
        <stream-id>
          <item key="copy" value="0"/>
        </stream-id>
      </srt-extensions>
    </server>
  </servers>
  ...
</service>
```

Child Elements

Element	Optional/Required	Description
<stream-id>	Required	Provides element with custom parameters for the stream ID. Each child element of stream-id has 1 or more item elements with a key/value pair.

Profiles Element

The <profiles> element consists of 1 or more <profile> child elements that define streaming quality. The <profiles> element is a required child of the <service> element. Defining multiple profiles allows specifying custom bitrates for different streaming qualities.

The following is an example of a <profiles> element block that defines 3 profiles.

```
<service>
  ...
  <profiles default="Streaming High">
    <profile>
      <name>Streaming High</name>
      <!-- Define <config> elements to specify target
bitrates for Streaming High profile -->
    </profile>
    <profile>
      <name>Streaming Medium</name>
      <!-- Define <config> elements to specify target
bitrates for Streaming Medium profile -->
    </profile>
  </profiles>
  ...
</service>
```

Attributes

Attribute	Optional/Required	Description
default	Optional	The name of the default profile

Child Elements

Element	Optional/Required	Description
<name>	Required	The name of the profile
<config>	Required	Video mode dependent quality settings for profile (see below)

Config Element

The <config> element defines a mapping between the video resolution and frame rate and the target bitrate for the quality level. The <config> element is a child of the <profile> element.

The following is an example of a <config> element block for setting the target bitrate for a high quality stream with 720p60 and 1080p60 video inputs.

```
<profile>
  <name>Streaming High</name>
  <config resolution="720p" fps="60" codec="H264">
    <bitrate>6000000</bitrate>
    <audio-bitrate>128000</audio-bitrate>
  </config>
  <config resolution="1080p" fps="60" codec="H264">
    <bitrate>8000000</bitrate>
    <audio-bitrate>128000</audio-bitrate>
  </config>
  <!-- <config> elements for other resolutions and frame rates -->
</profile>
```

Attributes

Attribute	Optional/Required	Description
resolution	Required	The resolution of the streaming video mode
fps	Required	The frame rate of the streaming video mode (frames per second)
codec	Optional	The codec for encoding the streaming video - "H264" (default) or "H265"

Child Elements

Element	Optional/Required	Description
<bitrate>	Required	The target bitrate of the streaming video (bits per second)
<audio-bitrate>	Optional	The target bitrate of the streaming audio (bits per second)

The supported streaming quality bitrates can be found in section `Using Web Presenter Setup` section earlier in this manual.

TIP For each <config> element block, choose a maximum resolution and fps to cover all video modes for the target bitrate. For example, defining a <config> element with resolution="1080p" and fps = "30" will apply for video modes 1080p23.98, 1080p24, 1080p25, 1080p29.97 and 1080p30.

For audio bitrate, only 128 Kb/s is supported.

Credentials Element

The <credentials> element allows specifying an RTMP session username and password if required by the service. The <credentials> element is an optional child to service element.

The following is an example of a <credentials> element block that defines a username and password for the streaming service.

```
<service>
  ...
  <credentials>
    <username>myusername</username>
    <password>abcd1234</password>
  </credentials>
  ...
</service>
```

Child Elements

Element	Optional/Required	Description
<username>	Required	RTMP session username
<password>	Required	RTMP/SRT session password

Ayuda

Cómo obtener ayuda

Visite nuestra página de soporte técnico a fin de obtener ayuda rápidamente y acceder al material de apoyo más reciente para los productos descritos en este manual.

Página de soporte técnico

La versión más reciente de este manual se encuentra disponible en nuestra página de soporte técnico.

Foro

Nuestro foro permite compartir ideas creativas y constituye un recurso útil para obtener más información sobre nuestros productos. Por otra parte, brinda la posibilidad de encontrar rápidamente respuestas suministradas por usuarios experimentados o por el personal de Blackmagic Design. Para acceder al foro, visite la página <https://forum.blackmagicdesign.com>.

Cómo ponerse en contacto con Blackmagic Design

Si no encuentra la ayuda que necesita, solicite asistencia mediante el botón **Enviar correo electrónico**, situado en la parte inferior de nuestra página de soporte técnico. De manera alternativa, haga clic en el botón **Soporte técnico local** para acceder al número telefónico del centro de atención más cercano.

Normativas



Desecho de equipos eléctricos y electrónicos en la Unión Europea:

Este símbolo en el producto indica que el dispositivo no debe desecharse junto con otros residuos domésticos. A tales efectos, debe ser entregado a un centro de recolección para su posterior reciclaje. Esto ayuda a preservar los recursos naturales y garantiza que el equipo se recicle de una manera que proteja la salud y el medioambiente. Para obtener más información en este sentido, comuníquese con el centro de reciclaje más cercano o el distribuidor donde adquirió el producto.



Según las pruebas realizadas, este equipo cumple con los límites indicados para dispositivos digitales Clase A, en conformidad con la sección 15 de las normas establecidas por la Comisión Federal de Comunicaciones. Estos límites han sido implementados para proporcionar una protección razonable contra interferencias nocivas al operar el dispositivo en un entorno comercial. Este equipo usa, genera y puede irradiar energía de radiofrecuencia, y si no se instala o utiliza de acuerdo con el manual de instrucciones, es posible que ocasione interferencias nocivas para las comunicaciones radiales. El funcionamiento de este equipo en una zona residencial puede ocasionar interferencias nocivas, en cuyo caso el usuario será responsable de solucionar el problema por cuenta propia.

El funcionamiento de este equipo está sujeto a las siguientes condiciones:

- 1 El dispositivo no debe ocasionar interferencias nocivas.
- 2 El dispositivo debe admitir cualquier interferencia recibida, incluidas aquellas que puedan provocar un funcionamiento incorrecto del mismo.



R-R-BMD-20201201001
R-R-BMD-20201201002

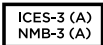

Declaración ISED (Canadá)

Este dispositivo cumple con las normas del gobierno de Canadá relativas a equipos digitales clase A.

Cualquier modificación o uso indebido del mismo podría acarrear un incumplimiento de dichas normas.

Las conexiones a interfaces HDMI deberán realizarse mediante cables blindados de gran calidad.

Este equipo cumple con las normas descritas anteriormente al emplearse en entornos comerciales. Nótese que podría ocasionar interferencia radial al utilizarlo en ambientes domésticos.

Seguridad

Este equipo debe enchufarse a una toma de corriente que disponga de una conexión a tierra.

A fin de reducir el riesgo de descarga eléctrica, evite exponer el equipo a goteras o salpicaduras.

Este equipo puede utilizarse en climas tropicales, a una temperatura ambiente máxima de 40 °C.

La temperatura de almacenamiento se sitúa entre -20 y 60 °C, con una humedad relativa de 0-90 % (sin condensación).

Compruebe que haya suficiente ventilación en torno a la unidad.

Al instalar el equipo en un bastidor, verifique que el dispositivo contiguo no impida la ventilación.

La reparación de los componentes internos del equipo no debe ser llevada a cabo por el usuario. Comuníquese con nuestro centro de atención más cercano para obtener información al respecto.



Evite utilizar el equipo a una altura mayor de 2000 metros.

Declaración del Estado de California

Las partes plásticas de este producto pueden contener trazas de compuestos químicos, tales como polibromobifenilos (PBB), que el Estado de California reconoce como causantes de cáncer, anomalías congénitas o daños reproductivos.

Consulte la página www.P65Warnings.ca.gov para obtener más información al respecto.

Garantía

36 meses de garantía limitada

Blackmagic Design ofrece una garantía de 36 meses a partir de la fecha de compra de este producto por defectos relativos a los materiales o la fabricación, a excepción de los conectores, cables, módulos de fibra óptica, fusibles y baterías, cuya garantía es de 12 meses. Si el producto resulta defectuoso durante el período de validez de la garantía, Blackmagic Design podrá optar por reemplazarlo o repararlo sin cargo alguno por concepto de piezas y/o mano de obra.

Para acceder al servicio proporcionado de acuerdo con los términos de esta garantía, el Cliente deberá dar aviso del defecto a Blackmagic Design antes del vencimiento del período de garantía y encargarse de los arreglos necesarios para la prestación del mismo. El Cliente será responsable del empaque y el envío del producto defectuoso al centro de servicio técnico designado por Blackmagic Design y deberá abonar las tarifas postales por adelantado. El Cliente será responsable de todos los gastos de envío, seguros, aranceles, impuestos y cualquier otro importe que surja con relación a la devolución de productos por cualquier motivo.

Esta garantía carecerá de validez ante defectos o daños causados por un uso indebido del producto o por falta de cuidado y mantenimiento. Blackmagic Design no tendrá obligación de prestar el servicio estipulado en esta garantía para (a) reparar daños provocados por intentos de personal ajeno a Blackmagic Design de instalar el producto, repararlo o realizar un mantenimiento del mismo; (b) reparar daños resultantes del uso de equipos incompatibles o conexiones a los mismos; (c) reparar cualquier daño o mal funcionamiento provocado por el uso de piezas o repuestos no suministrados por Blackmagic Design; o (d) brindar servicio técnico a un producto que haya sido modificado o integrado con otros productos, cuando dicha modificación o integración tenga como resultado un aumento de la dificultad o el tiempo necesario para reparar el producto. ESTA GARANTÍA OFRECIDA POR BLACKMAGIC DESIGN REEMPLAZA CUALQUIER OTRA GARANTÍA, EXPRESA O IMPLÍCITA. POR MEDIO DE LA PRESENTE, BLACKMAGIC DESIGN Y SUS DISTRIBUIDORES RECHAZAN CUALQUIER GARANTÍA IMPLÍCITA DE COMERCIALIZACIÓN O IDONEIDAD PARA UN PROPÓSITO PARTICULAR. LA RESPONSABILIDAD DE BLACKMAGIC DESIGN EN CUANTO A LA REPARACIÓN O SUSTITUCIÓN DE PRODUCTOS DEFECTUOSOS CONSTITUYE UNA COMPENSACIÓN COMPLETA Y EXCLUSIVA PROPORCIONADA AL CLIENTE POR CUALQUIER DAÑO INDIRECTO, ESPECIAL, FORTUITO O EMERGENTE, AL MARGEN DE QUE BLACKMAGIC DESIGN O SUS DISTRIBUIDORES HAYAN SIDO ADVERTIDOS CON ANTERIORIDAD SOBRE LA POSIBILIDAD DE TALES DAÑOS. BLACKMAGIC DESIGN NO SE HACE RESPONSABLE POR EL USO ILEGAL DE EQUIPOS POR PARTE DEL CLIENTE. BLACKMAGIC DESIGN NO SE HACE RESPONSABLE POR DAÑOS CAUSADOS POR EL USO DE ESTE PRODUCTO. EL USUARIO UTILIZA EL PRODUCTO BAJO SU PROPIA RESPONSABILIDAD.

© Copyright 2023 Blackmagic Design. Todos los derechos reservados. Blackmagic Design, DeckLink, HDLink, Videohub Workgroup, Multibridge Pro, Multibridge Extreme, Intensity y «Leading the creative video revolution» son marcas registradas en Estados Unidos y otros países. Todos los demás nombres de compañías y productos pueden ser marcas comerciales de las respectivas empresas a las que estén asociados.

El nombre Thunderbolt y el logotipo respectivo son marcas registradas de Intel Corporation en Estados Unidos y otros países.

Blackmagic Web Presenter





欢迎辞

感谢您购买Blackmagic Web Presenter!

Blackmagic Web Presenter可以直接连接到任何SDI设备, 将信号转换为H.264格式, 从而在YouTube Live、Facebook Live和Twitch等网络平台上直播。您还可以使用选购ATEM Streaming Bridge实现广播级高品质视频的点对点传输, 通过网络轻松实现专业视频的远程传输!

本操作手册向您介绍了Blackmagic Web Presenter使用前的准备工作以及如何使用各项功能及控制所需的全部信息, 包括如何设置YouTube Live、Facebook Live、Twitch、Zoom、Skype等内容。

登陆公司网站www.blackmagicdesign.com/cn并进入支持页面, 获得Blackmagic Web Presenter最新版操作手册及其内部软件更新。下载软件时, 请注册您的相关信息, 以便我们发布新软件时能及时通知您。

我们会不断增加新的功能和改进, 并期待大家的反馈!

A handwritten signature in black ink that reads "Grant Petty". The signature is written in a cursive, flowing style.

Grant Petty

Blackmagic Design首席执行官

目录

入门	270
使用Web Presenter的前面板	273
LCD显示屏	274
使用监看输出	275
使用Web Presenter Setup	280
Live Stream (流媒体直播) 选项卡	281
Setup (设置) 选项卡	284
Network (网络) 设置	285
设置互联网共享进行直接推流	285
通过智能手机推流	286
将Blackmagic Web Presenter作为网络摄像头使用	286
设置Open Broadcaster	286
使用ATEM Streaming Bridge创建视频连接	289
创建XML文件	290
导出XML文件	290
Tally、对讲和摄影机控制	291
连接URSA Broadcast G2	292
Blackmagic Universal Rack Shelf	293
包含组件	293
将设备安装到机架上	294
安装1/6机架宽度空白挡板	294
安装侧面的1/3机架宽度空白挡板	294
更新内部软件	295
Developer Information	296
Blackmagic Web Presenter Ethernet Protocol	296
Blackmagic Streaming XML Format	309
Overview	309
Streaming XML Definition	309
帮助	316
监管声明	317
安全信息	318
保修	319

入门

Blackmagic Web Presenter使用前的准备工作非常简单! 只需要连接电源, 然后连接视频和音频, 再将设备连接到您的计算机, 最后联网即可。

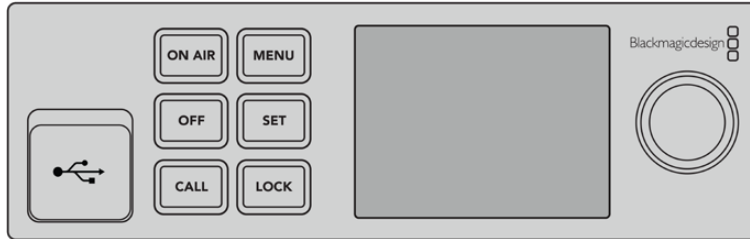

Blackmagic Web Presenter前面板

连接电源

将标准IEC电源线插入位于Blackmagic Web Presenter后面板的电源输入端口。

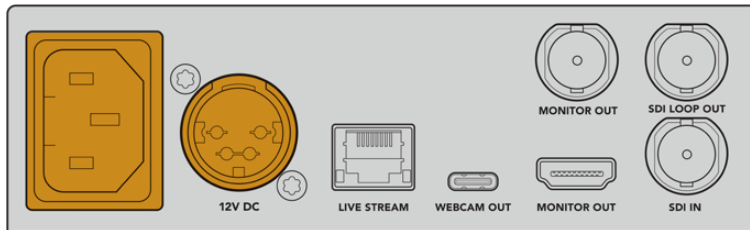

Blackmagic Web Presenter可通过IEC或12V DC电源输入获得电源。

此外, Web Presenter还设有额外的12V DC电源输入。这一电源输入可以用来连接如UPS不间断电源或外接12V电池电源等外部电源供应, 从而实现冗余方案。

连接视频和音频

将您的视频源连接到Blackmagic Web Presenter的SDI输入上。连接视频后, 画面将会显示在Web Presenter的内置LCD上。音频会嵌入到所连接的SDI视频信号上, 您可以通过观察LCD上的音频表加以确认。

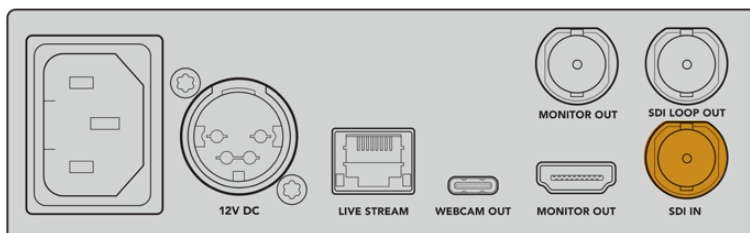

将视频连接到Blackmagic Web Presenter的SDI输入上

Blackmagic Web Presenter支持12G-SDI, 并且当视频输入改变时, 它会自动在HD和Ultra HD之间切换, 最高可达2160p60。Blackmagic Web Presenter 4K能够以Ultra HD推流, 而Blackmagic Web Presenter HD几乎可以将任何视频信号下变换为1080p。

连接到监视器

将HDMI电视机或SDI监视器连接到其中一个监看输出上。这样就能监看播出内容，并查看随视频流时刻更新变化的重要状态信息。更多关于如何使用监看输出的内容，请阅读“使用监看输出”部分的介绍。

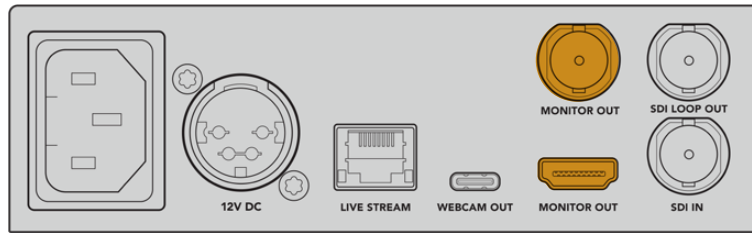

将监视器连接到Web Presenter的监看输出

通过USB连接计算机

使用Web Presenter前面板或后面板的USB-C端口将设备连接到您的计算机。您可以通过这些USB端口使用Blackmagic Web Presenter Setup实用程序进行设备更新和配置。第一次为Web Presenter完成配置后，请将设备从计算机上断开连接。

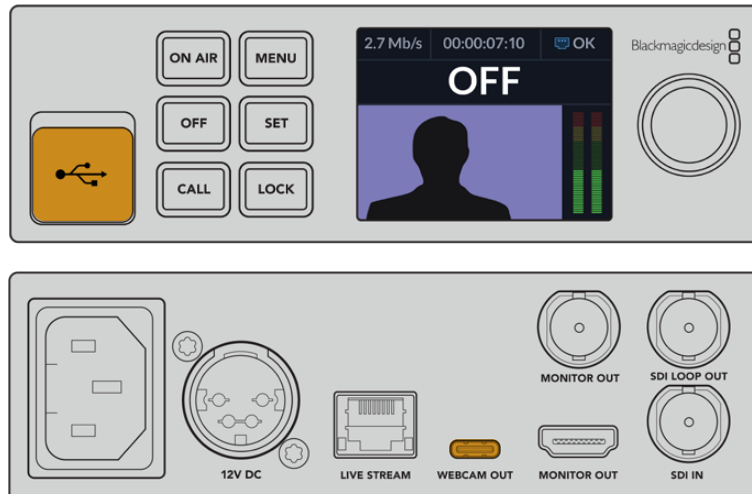

使用Blackmagic Web Presenter前面板或后面板的USB端口将设备连接到您的计算机

连接到网络

要将Blackmagic Web Presenter连接到网络，只需使用一根网线将标有“LIVE STREAM”字样的以太网端口和网络路由器或网络交换机即可。

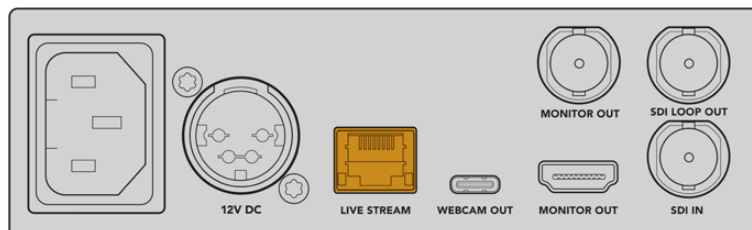

将Blackmagic Web Presenter通过后面板的以太网端口连接网络

设置直播视频流

现在, 您可以设置Web Presenter并通过YouTube Live、Facebook Live、Twitch等任何直播平台进行流媒体直播了。本例中, 我们将设置YouTube Live进行直播。

- 1 复制YouTube Studio账户的视频流密钥。
- 2 登录网址www.blackmagicdesign.com/cn/support, 下载Blackmagic Web Presenter Setup实用程序, 并将它安装到您的计算机上。该软件可用于配置首次进行流媒体直播的各项设置。
- 3 运行Blackmagic Web Presenter Setup实用程序, 进入“流媒体直播”页面。
- 4 将直播“平台”设置为“YouTube”, 将“服务器”设置为“Primary”。将您的YouTube视频流密钥复制到“密钥”栏, 并选择一个直播质量。点击“保存”。
- 5 一切准备就绪, 马上可以开始全球直播了! 点击“On Air”按钮或按下设备前面板上的“ON AIR”按钮。直播结束后, 按“OFF” (关) 按钮停止播出。

使用SRT推流协议

安全可靠传输协议 (简称SRT) 与RTMP相比而言, 可提供更低延迟的流媒体直播。SRT还可以通过类似密钥的密码短语来提升安全性。

当选择SRT协议版本的推流服务时, 从您的流媒体账户上复制密码和视频流密钥, 粘贴到Blackmagic Web Presenter Setup实用程序的“Key” (密钥) 和“Passphrase” (密码短语) 栏。

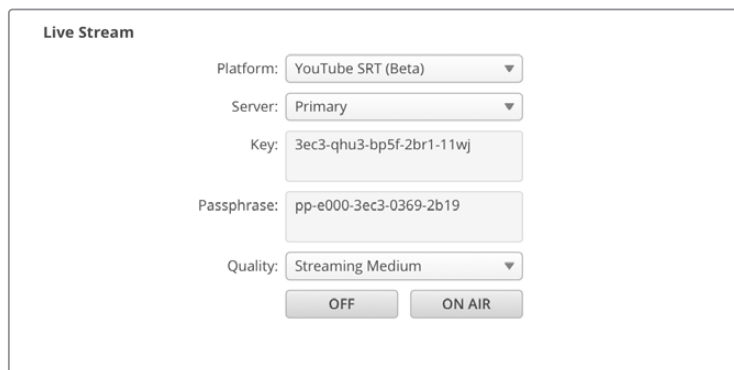

The screenshot shows a 'Live Stream' configuration window with the following fields and values:

- Platform: YouTube SRT (Beta)
- Server: Primary
- Key: 3ec3-qhu3-bp5f-2br1-11wj
- Passphrase: pp-e000-3ec3-0369-2b19
- Quality: Streaming Medium

At the bottom of the window, there are two buttons: 'OFF' and 'ON AIR'.

将密码短语粘贴到Setup实用程序的“Passphrase”栏

如果技术经验丰富的播出方想要自定义推流设置, 那么RTMP或SRT协议以及H.264或H.265编解码可在XML文件中进行更改。详情请参阅“Blackmagic流媒体XML格式”部分的内容。

使用Web Presenter的前面板

Blackmagic Web Presenter前面板上的各项控制可以用来开始或停止流媒体直播或更改设置。

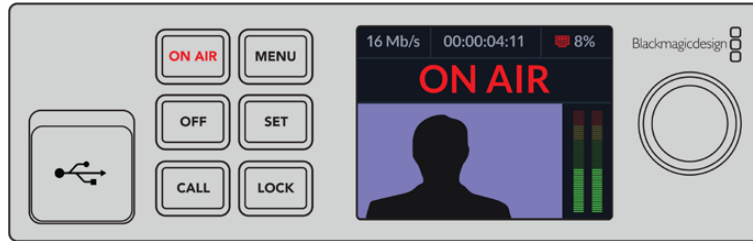

ON AIR – 按下“ON AIR”按钮可开始流媒体直播。直播进行过程中, 该按钮会亮起红色。

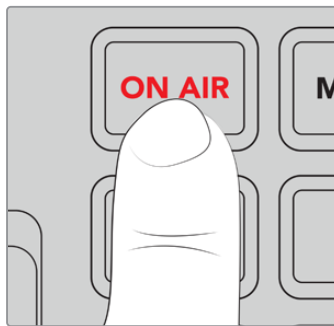

如果“ON AIR”按钮闪烁, 则表示流媒体直播无法开始, 或者意外停止, 这可能是您的网络连接或流媒体设置出了问题所导致的。请检查网络连接是否正常, 以及流媒体设置是否正确。

OFF – 按下“OFF”按钮可停止流媒体直播。

MENU – 按下“MENU”按钮可在LCD屏幕上打开设置菜单。

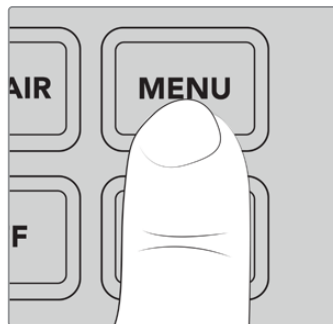

更改设置步骤如下:

- 1 转动旋钮选定您想要更改的设置, 然后按“SET”按钮。



- 2 转动旋钮更改设置。
- 3 再次按“SET”按钮确认更改。

按“MENU”按钮逐层回到上一级菜单选项，并返回屏幕主页。

CALL – 该功能将在未来的更新中添加。

LOCK – 长按该按钮一秒可锁定设备面板，从而禁用按钮功能，防止他人因意外触碰按钮导致直播开始或停止。启用这一功能时，该按钮会亮起红色。

长按该按钮2秒可解除设备面板的锁定功能。

LCD显示屏

开启Web Presenter时，您最先看到的是屏幕主页。屏幕主页会显示重要的信息，具体包括：

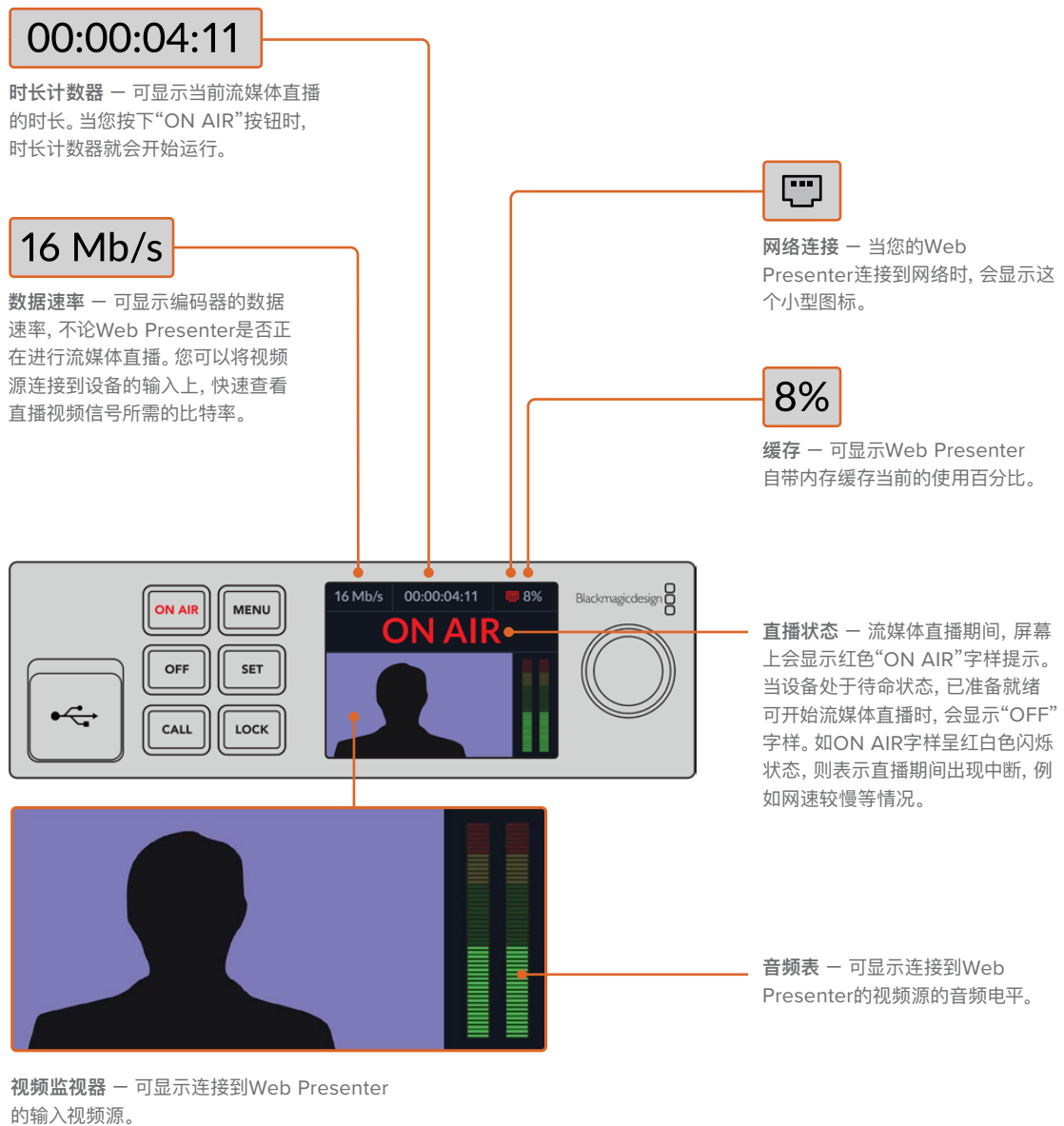

网络连接图标



显示蓝色的以太网图标, 表示设备已连接以太网线, 并将使用以太网连接进行流媒体直播。



显示红色的以太网图标, 表示设备正通过以太网进行流媒体直播。



显示蓝色的智能手机图标, 表示设备将连接并使用智能手机的共享网络进行流媒体直播。



显示红色的智能手机图标, 表示设备正通过智能手机的共享网络进行流媒体直播。

提示 如果未显示任何图标, 则表示您的Web Presenter没有连接到网络。

使用监看输出

监视器输出可用于监看视频输入画面、音频电平、直播状态、数据速率、缓存级别, 以及SDI输入的技术信息。



Blackmagic Web Presenter的监看输出提供了全面的信息, 包括数据速率和缓存状态。

监看输出显示由8个面板区域组成。以下是每个面板区域的描述及其显示的信息。

输入画面

这一主要的面板区域可显示来自当前连接SDI视频源的视频输入。



直播状态

流媒体直播前，直播状态提示将显示“关”，表示Web Presenter此刻为待命状态，可以开始播出。开始流媒体直播后，这一状态提示将亮起红色“ON AIR”字样，直到直播结束。



时长计数器位于直播提示下方。当您按下Web Presenter的“ON AIR”按钮时，时长计数器将会开始运行。

如果Web Presenter处于非直播状态，但即将通过智能手机的共享网络进行直播，此时“OFF”提示字样一侧的角落就会显示一个蓝色的智能手机图标。直播时，这个智能手机图标将会亮起红色。

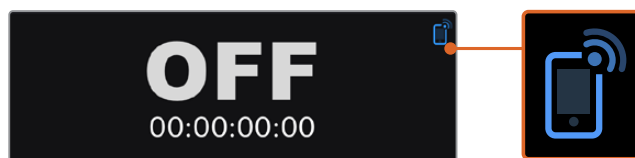

流媒体直播

流媒体直播面板可显示直播设置的相关信息，包括流媒体平台、服务器和协议。同时显示的还有直播的分辨率以及画质设置。

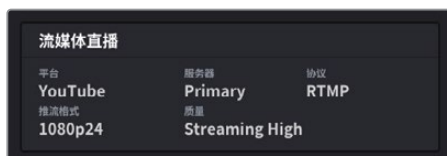

视频输入

视频输入面板的顶部设有5个小型检视器, 它们可显示直播画面的前6秒内容, 每个小型检视器分别占1.2秒直播时间。



小型检视器下方显示的是Web Presenter的SDI输入上所连接视频输入源的具体技术信息。

输入格式	可显示SDI视频输入的分辨率和帧率。Web Presenter最高支持2160p60。
色域标准	可显示SDI视频输入的色彩空间。Web Presenter支持Rec.601、Rec.709和Rec.2020色彩空间。
SDI辅助数据	辅助数据是SDI视频输入上所携带的视频之外的数据。这包括嵌入音频, 时间码, 以及隐藏式字幕。如果您的SDI输入包含辅助数据, 此处就会显示“具备”提示字样。

时间码	可显示SDI视频输入源的时间码。
隐藏式字幕	如果您的SDI视频输入包含隐藏式字幕, 此处就会显示相应的格式。支持的有CEA-608和CEA-708格式。
SMPTE 292 CRC	这是SDI视频的错误检查功能。如果您的Web Presenter检测到SDI视频输入中出现问题, 则会显示某项错误。CRC错误通常是因SDI线缆故障或线缆过长所导致。
亮度Y比特和色度比特	<p>“亮度Y比特”和“色度比特”的信息提示可显示SDI视频输入信号的活动情况。每个字母都代表视频信号中一个比特位的状态。</p> <p>X – “X”表示一个持续变化的比特位。</p> <p>L – 低比特位。</p> <p>H – 高比特位。</p> <p>为了便于理解, SDI偏置已被减去。例如, 视频为黑色时, 所有比特位都是低比特位。</p> <p>通常来说, SDI视频输入的所有10个比特位都会显示“X”, 表示视频流的所有比特位都处于持续变化的状态。如果您的SDI输入是8bit视频, 那么最右侧的两个比特位将始终为“L”, 因为它们不具备任何数据。如果某个比特位显示“L”或“H”, 而您却认为它应显示“X”, 这表示当中存在“stuck bit”, 并且有可能在上游视频中导致错误。</p>

音频输入

音频输入面板顶部的音频波形可显示直播视频流中过去6秒音频的相关信息。该显示会不断更新，从右到左滚动显示。

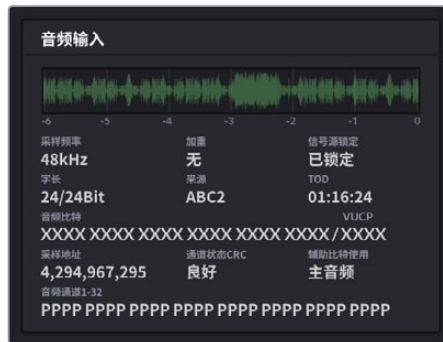

您可以在音频波形显示的下方查看该音频输入的具体技术信息。

采样频率	可显示SDI输入上内嵌音频的采样频率。
加重	可提示您的音频源是否启用了加重选项。
音频源锁定	可提示音频源频率是否被锁定到外部参考源。
字长	可显示SDI输入上内嵌音频的位深。
来源	四字符，表示通道来源。
TOD	自由运行的时间码。
音频比特	可显示SDI连接内嵌音频样本中的比特活动情况。即使音频通道状态显示您有16、20或24bit音频，音频比特活动情况也会加以确认。
VUCP	从左到右，“V”表示“有效性”比特，“U”表示“用户”数据比特，“C”表示“信道状态”比特，而“P”则表示“偶校验”比特。这一栏相当于“音频比特”。
采样地址	音频采样计数器。
辅助比特使用	可提示AUX比特是否用于主音频。
音频通道1-32	每个数字均代表SDI输入上的一个嵌入音频通道。“P”表示音频通道正在使用中，“-”表示该通道没有音频。

数据速率显示

数据速率可显示编码器在过去60秒里的当前数据速率。数据速率的单位为兆比特每秒。即使不处于直播状态，这一提示信息依然会持续显示，以便您在直播前准确测量带宽。

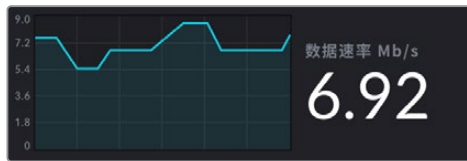

缓存显示

缓存显示可给出Web Presenter内置存储缓冲器当前的使用百分比，图表可显示过去60秒的缓存使用情况。缓存是很小一部分内部存储，可持续记录和播放节目输出。在遇到流媒体直播数据速率下降到无法维持视频信号的水平时，它可以作为确保安全的措施。

网络变化大多数是因为网络活动或无线信号强度，因此如果播出数据速率降低，缓冲数据就会相应加快。如果连接速度太慢以至于无法支持视频流，那么缓存就会填充视频帧加以补偿。但是，一旦缓存达到100%满额，视频流就会有所损失，因此请尽量避免出现缓存满额的情况。您无需开始直播就能进行测试，只需连接视频信号并观察监看输出上的缓存显示即可。如果缓存频繁接近100%，可在流媒体直播设置中选择一个较低质量的选项。

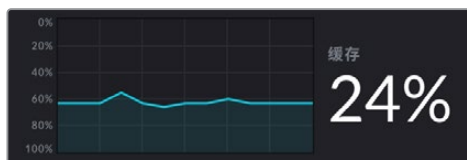

音频表类型

您可以使用音频表来监看音频源的电平，具体可到Web Presenter的菜单设置中将电平表设置为PPM表或VU表显示标准。如果您的音频电平过高，音频表就会亮起红色，表示直播视频可能出现失真或削波。因此，请尽量将音频保持在靠近绿色区域顶格，并偶尔触及黄色区域的范围内。

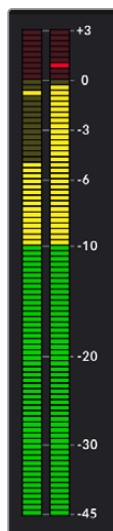

使用Web Presenter Setup

当您的Blackmagic Web Presenter连接到某一网络时, 该网络中的任何计算机都可被用来远程控制您的Web Presenter。您可以使用Blackmagic Web Presenter Setup软件进入与硬件前面板上相同的控制和设置。

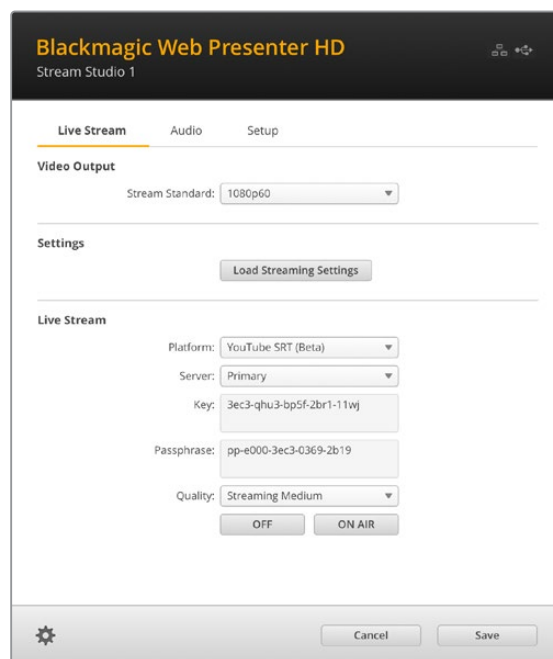
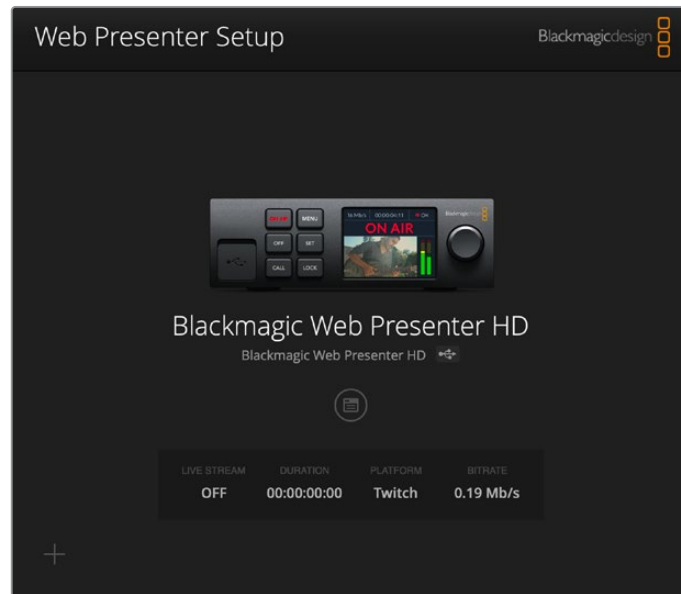

Live Stream (流媒体直播) 选项卡

Video Output (视频输出)

Stream Standard (推流格式)

点击“Stream Standard”菜单可选择直播的视频分辨率设置。根据使用的Web Presenter型号, 您可以选择从720p25到1080p60或2160p60。

Settings (设置)

如果您有自定义流媒体直播设置, 比如来自Blackmagic ATEM Streaming Bridge的XML文件, 可以点击“Load Streaming Settings”按钮导入此类文件。

更多关于如何创建自定义设置和连接ATEM Streaming Bridge的信息, 请参考本手册中“使用ATEM Streaming Bridge创建视频连接”部分的介绍。

Live Stream (流媒体直播)

Platform (平台)

点击“Platform”菜单, 为播出选择流媒体平台。选项包括Facebook、YouTube和Twitch。如果您导入了自定义流媒体设置, 这一列表中也会出现其他平台名称。

要推流到自定义URL, 请从“Platform”菜单里选择自定义URL选项。在Web Presenter 4K上, 您可以选择通过H.264或H.265推流到自定义URL; 在Web Presenter HD上, 您可以通过H.264推流到自定义URL。

Server (服务器)

从列表中选择离您所在地最近的服务器。服务器列表会根据您所选的流媒体直播平台而有所不同。

如果要推流到Instagram、Microsoft Teams或自定义URL, 服务器列表将成为可编辑文本框。请输入您的流媒体平台帐户分配信息或自定义URL信息。

Key (密钥)

输入流媒体平台指派给您播出所用的视频流密钥。

Passphrase (密码短语)

如果您使用的推流服务设有SRT视频流协议, 那么请输入您流媒体平台分配的密码短语。

Quality (质量)

根据您使用的Web Presenter型号, 选择HD或4K推流质量。

H.264	
HD	4K
HyperDeck High 45 to 70 Mb/s	HyperDeck High 95 to 220 Mb/s
HyperDeck Medium 25 to 45 Mb/s	HyperDeck Medium 66 to 150 Mb/s
HyperDeck Low 12 to 20 Mb/s	HyperDeck Low 38 to 80 Mb/s
Streaming High 6 to 9 Mb/s	Streaming High 34 to 51 Mb/s
Streaming Medium 4.5 to 7 Mb/s	Streaming Medium 23 to 35 Mb/s
Streaming Low 3 to 4.5 Mb/s	Streaming Low 13 to 20 Mb/s

H.265	
HD	4K
Streaming High 2.3 to 4.5 Mb/s	Streaming High 22.5 to 30 Mb/s
Streaming Medium 1.5 to 3 Mb/s	Streaming Medium 14 to 20 Mb/s
Streaming Low 0.8 to 2 Mb/s	Streaming Low 8 to 10 Mb/s

质量设置使用的数据速率会根据Web Presenter的视频格式而改变。比如, 如果选择“Streaming High”的高质量流媒体, 并以1080p24运行, 则会使用6Mb/s的数据速率。

如图表所示, 流媒体数据速率比HyperDeck的速率低。这样就可以通过网络传送数据, 这种方式比在硬盘上记录数据使用的带宽更低。

您会发现每个设置都提到了两种数据速率。较低的数字用于24p、25p和30p等较低的帧率, 而较高的数据速率用于50p和60p等较高的帧率。另外值得注意的是, 流媒体质量的默认设置是“Streaming High”, 这能为流媒体直播频道提供非常高的画质。

“OFF”和“ON AIR”按钮

使用“OFF”和“ON AIR”按钮可分别停止或开始直播。直播期间, “ON AIR”按钮会亮起红色。

移除导入设置

要将所有导入推流设置从Web Presenter移除, 请点击“Live Stream”选项卡左下角的齿轮图标。点击“Remove”确认移除。

Audio (音频) 选项卡

音频选项卡包括配置Web Presenter音频监看输出和音频表选项。

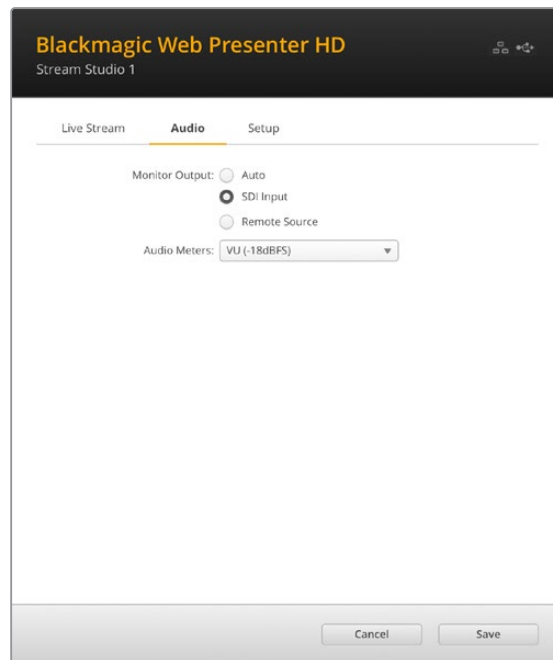

Monitor Output (监看输出)

通过监看输出选项可为Web Presenter的SDI和HDMI监看输出选择所使用的音频源。

Auto (自动)

当监看输出设为“Auto”时, Web Presenter将自动检测并监看通过ATEM Streaming Bridge发送自ATEM切换台的对讲音频。如果没有检测到对讲, 那么将使用来自SDI输入的音频。

SDI Input (SDI输入)

选择“SDI Input”可监看来自Web Presenter的SDI输入音频, 例如所连接的Blackmagic Studio Camera。

Remote Source (远程信号源)

使用该选项可监看来自远程ATEM切换台或ATEM Streaming Bridge的对讲音频。

Audio Meters (音频表)

使用音频表菜单可选择显示的音频表类型。选项包括: VU -18dBFS、VU -20dBFS、PPM -18dBFS或PPM -20dBFS参考电平。

Setup (设置) 选项卡

The screenshot shows the 'Setup' tab of the Blackmagic Web Presenter HD interface. It includes fields for Name, Language, and Software. The Network section is expanded, showing options for Protocol (DCHP or Static IP), IP Address, Subnet Mask, Gateway, Primary DNS, and Secondary DNS. There are also options for Connection Priority (Ethernet or Mobile) and a Factory Reset button. The interface is clean and professional, with a dark header and light background for the settings.

Name (名称)

如果您想为Web Presenter重新命名, 请在该文本框中输入新的名称并点击“Save”保存。

Language (语言)

可更改设备的语言设置。

Software (软件)

可显示Web Presenter当前的软件版本。

Network (网络)

这些设置可用来配置多个选项, 例如是通过DHCP还是使用静态IP地址连接网络。更多关于将Web Presenter连接到网络的信息, 请参考“网络设置”部分的介绍。

Connection Priority (优先连接) – 当以太网和手机同时连接到Web Presenter时, 这一设置可用来选择优先连接哪个方案进行流媒体直播。更多关于手机网络共享的信息, 请参考“通过智能手机推流”部分的介绍。

Reset (重置)

点击“Factory Reset” (恢复出厂设置) 按钮可重置您的Web Presenter。

Network (网络) 设置

Web Presenter可以使用静态IP地址或DHCP连接到网络。

DHCP – 即“动态主机配置协议”，是用于网络服务器和路由器的协议，它可以自动寻找您的Web Presenter并为其指派一个IP地址。DHCP能方便设备通过以太网实现连接，并确保设备的IP地址不会发生冲突。大部分计算机和网络交换机都支持DHCP。

Static IP (静态IP) – 如果您想要自行设置IP地址，只需将该协议设置选为“Static IP”并手动更改IP设置即可。

即使Web Presenter重启，静态IP地址也不会发生改变。

如果您将Web Presenter连接到公司网络中，那就可能需要使用静态IP地址。如果有网络管理员，那么您的网络就有可能为所有连接的设备提供自定义IP地址。如果有网络管理员负责管理您的计算机和公司网络，建议您向他们咨询。

设置互联网共享进行直接推流

如果您无法将Web Presenter直接连接到网络交换机或网络路由器，可以通过Web Presenter的以太网端口，将计算机的网络连接和Web Presenter进行共享。

设置Blackmagic Web Presenter进行直接推流的步骤如下：

- 1 将Web Presenter设置为使用DHCP。
- 2 配置您的计算机，使其通过以太网端口共享网络连接。

Mac: 打开“系统偏好设置”，点击“共享”然后从“服务”列表选择“互联网共享”。如果您的Mac通过Wi-Fi连接到互联网，在“共享以下来源的连接”菜单中，选择“Wi-Fi”。在“用以下端口共享给电脑”列表中，选择“以太网”。在“服务”列表中，勾选“互联网共享”复选框。当弹出对话框询问是否确定要开启互联网共享时，请点击“启动”。

Windows: 右键点击“开始”菜单，选择“网络连接”。在“网络状态”窗口中，点击“更改适配器选项”，会出现您计算机的网络连接列表。右键点击网络连接并选择“属性”。在“共享”选项卡中，勾选“允许其他网络用户通过此计算机的Internet连接来连接”。在菜单中选择一个网络连接，然后点击“确定”。
- 3 将Web Presenter连接到计算机的以太网端口。等待几秒后，DHCP就会为Web Presenter指派一个IP地址。
- 4 当设备LCD屏幕右上角出现以太网图标时，可确认Web Presenter通过以太网连入互联网。

通过智能手机推流

Blackmagic Web Presenter可通过智能手机共享网络进行流媒体播出。因此，只要您的智能手机有4G或5G蜂窝网络连接，就可以从世界任何地方进行推流。

设置手机网络共享：

- 1 通过USB-C线缆将智能手机连接至Blackmagic Web Presenter。您可以使用前面板或底部的USB-C接口。
- 2 开启智能手机的互联网热点。

在您的iOS设备上打开“设置” > “个人热点”，并确保“允许他人加入”选项是启用的。在安卓设备上，滑动屏幕显示快捷菜单。长按热点图标，然后打开USB网络共享。

现在，在Blackmagic Web Presenter上按“ON AIR”按钮就可以开始直播。

提示 推流完成后，建议您关闭网络共享连接，以保存手机电量。

如果您的Web Presenter连接有以太网线缆，建议您确认设备配置了使用手机网络共享。打开Web Presenter Setup实用程序，并进入“Setup”（设置）选项卡。在“Network”（网络）设置中，将“Connection Priority”（优先连接）设为“Mobile”（移动网络）。

将Blackmagic Web Presenter作为网络摄像头使用

Skype或Zoom等软件会自动将Web Presenter视为网络摄像头，因此当您运行此类程序时，可以立即看到来自Web Presenter的视频。如果应用程序没有自动选择Web Presenter，您可以手动将Web Presenter设置为网络摄像头和麦克风使用。

以下举例说明如何在Skype上设定网络摄像头设置。

- 1 点击“Skype”菜单栏，打开“音频和视频设置”。
- 2 点击“摄像头”菜单，并从列表中选择“Web Presenter”。此时，预览窗口就会显示来自Web Presenter的视频画面。
- 3 到“麦克风”菜单中，将“Web Presenter”选为音频源。

设置Open Broadcaster

Open Broadcaster是一个开源程序，是Web Presenter与YouTube、Twitch、Facebook Live等常用流媒体软件之间的流媒体平台。Open Broadcaster会把视频压缩到流媒体程序易于管理的比特率。

以下示例演示了如何设置Open Broadcaster，从而使用YouTube Live流媒体程序直播来自Web Presenter的网络摄像头输出内容。

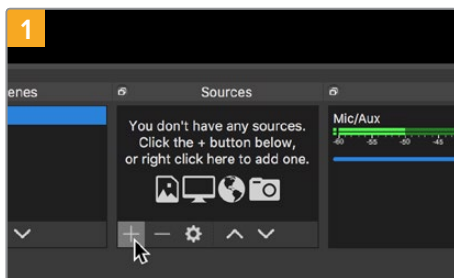

1 打开Open Broadcaster, 点击“Sources”窗口中的加号图标。

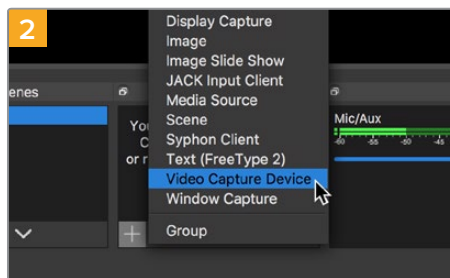

2 选择“Video Capture Device”。

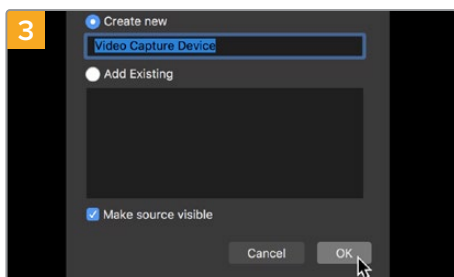

3 为新信号源命名并点击“OK”。

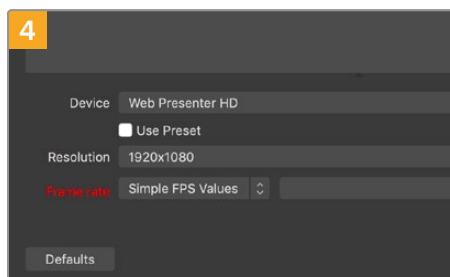

4 在设备菜单中, 选择“Web Presenter”型号并点击“OK”。

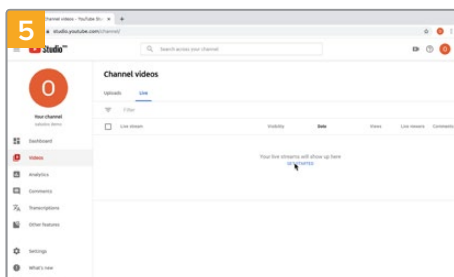

5 打开您的YouTube账号。点击“开始直播”按钮, 然后点击“直播”。

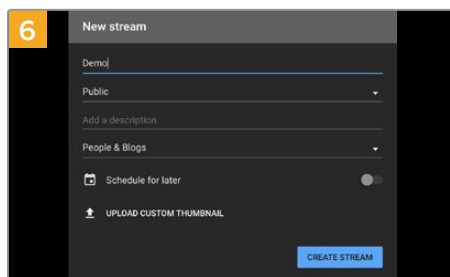

6 在YouTube“直播”选项中, 键入您的播出内容信息, 点击“创建直播”。

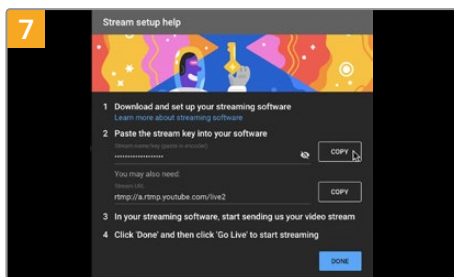

7 YouTube会生成视频流密钥, 以便将Open Broadcaster导向您的YouTube账户。

8 点击视频流密钥一侧的“复制”按钮。复制将要粘贴到Open Broadcaster的视频流密钥。

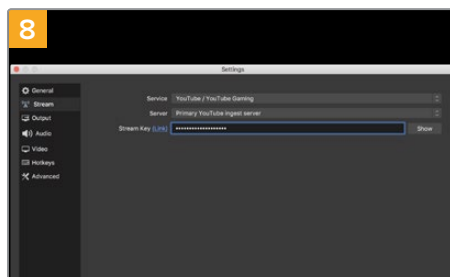

9 回到Open Broadcaster, 在菜单栏中点击“OBS/Preferences”打开偏好设置。选择“Stream”。粘贴刚才从YouTube复制的视频流密钥, 并点击“OK”。

10 现在, Open Broadcaster的流媒体预览窗口中就会显示来自Web Presenter的视频。

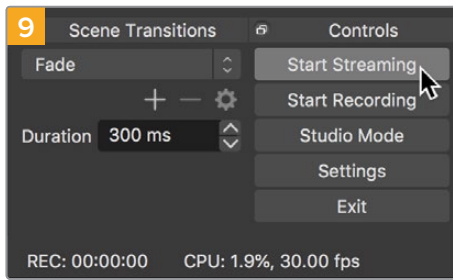

要把Open Broadcaster的播出与YouTube建立链接，请到屏幕右下角点击“Start Streaming”。该步骤可以建立从Open Broadcaster到YouTube的链接，此后一切设置都可在YouTube Live中完成。

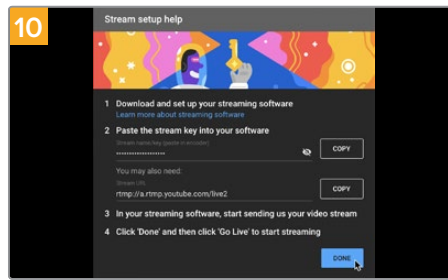

回到YouTube Live，您会看到背景中显示来自Web Presenter的网络摄像头节目输出画面。点击“DONE”（完成）。

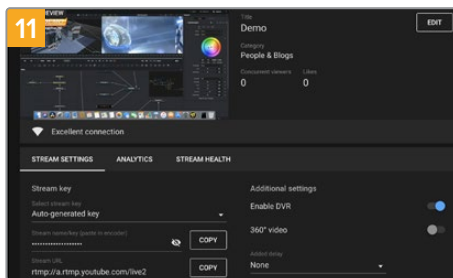

Open Broadcaster和YouTube Live建立通信后，一切基本准备就绪。开始播出前，请最后检查一遍，确保运行正常。

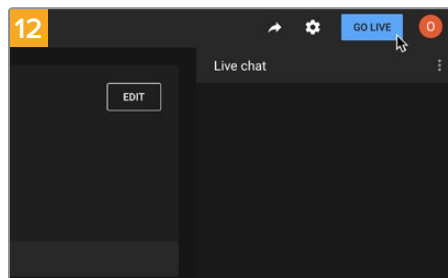

检查并确认后，点击“Go Live”就可以开始直播了。

现在，您就已经开始使用Open Broadcaster通过YouTube平台进行直播了。

备注 由于网络直播经常会出现延迟，因此请务必先检查YouTube上的播出画面，确认节目结束后，再点击“End Stream”，从而防止过早结束直播的情况。

使用ATEM Streaming Bridge创建视频连接

ATEM Streaming Bridge能对来自任何Web Presenter推出的视频流解码, 并将信号转换回SDI或HDMI视频, 从而通过本地网络发送视频, 或者通过互联网将视频发送到任何地点。

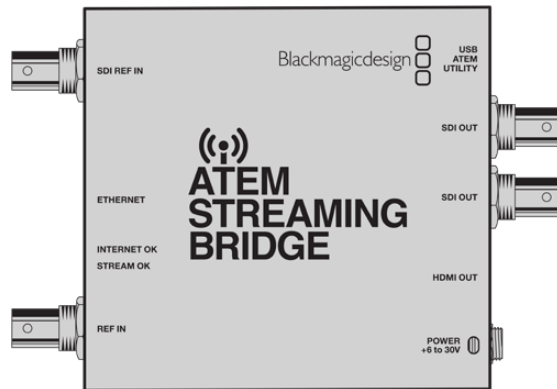

如果ATEM Streaming Bridge连接到Web Presenter所在的同一个本地网络中, 它就会出现在Web Presenter Setup直播选项卡上“平台”菜单中。

如果没有, 您可以将安装有流媒体直播设置XML文件的USB硬盘连接到Web Presenter上加载该文件, 或者使用Web Presenter Setup通过计算机加载相应文件。

Blackmagic Web Presenter和ATEM Streaming Bridge搭配工作的典型例子就是, 从一个远程位置将气象预报节目传输到演播室。要实现远程信号传输, 您只需要一台Web Presenter和网络连接, 其中网络连接可以使用智能手机共享网络, 也可以通过联网实现。

演播室方面, ATEM Streaming Bridge会负责接收网络信号, 并将其转换为SDI信号, 以便连接演播室的主切换台。

工作流程设置如下:

- 1 在现场, 将Blackmagic Web Presenter 连接到切换台的SDI节目输出, 比如ATEM Constellation 8K。
- 2 然后, 再将Blackmagic Web Presenter连接智能手机。
- 3 在演播室, 将ATEM Streaming Bridge通过以太网连接到同一个网络。
- 4 然后, ATEM Streaming Bridge会通过网络将转换后的SDI视频信号发送到演播室切换台的SDI输入, 供新闻播报使用。

要为您的演播室实现ATEM Streaming Bridge和Web Presenter网络信号之间的连接, 您需要运行ATEM Setup Utility软件, 配置网络设置。这包括生成一个包含所有推流设置的XML文件, 并将其加载到位于其他地点的Web Presenter上。

创建XML文件

如要创建XML设置文件, 用一根网线连接以太网端口和网络路由器或者网络交换机, 将ATEM Streaming Bridge接入互联网。

使用一根USB-C线缆将ATEM Streaming Bridge连接到计算机, 然后运行ATEM Setup。

在设置选项卡中确认网络设置是否正确, 然后在“Stream Service”选项中选择“Internet”。网络状态框中会显示“Visible Worldwide” (全世界可见) 信息, 表示一切运行正常。

关于端口转发的备注

如果看到“Internet Status” (网络状态) 框显示端口转发或UPnP错误, 您需要通知网络提供商或网络管理员把网络连接的端口转发设置为“TCP port 1935”。

导出XML文件

您在确认ATEM Setup选项卡中的设置, 并成功将ATEM Streaming Bridge连接到本地网络或互联网后, 就可以导出XML设置文件了。

- 1 点击窗口右上方的“External ATEM Mini Pro”选项卡。

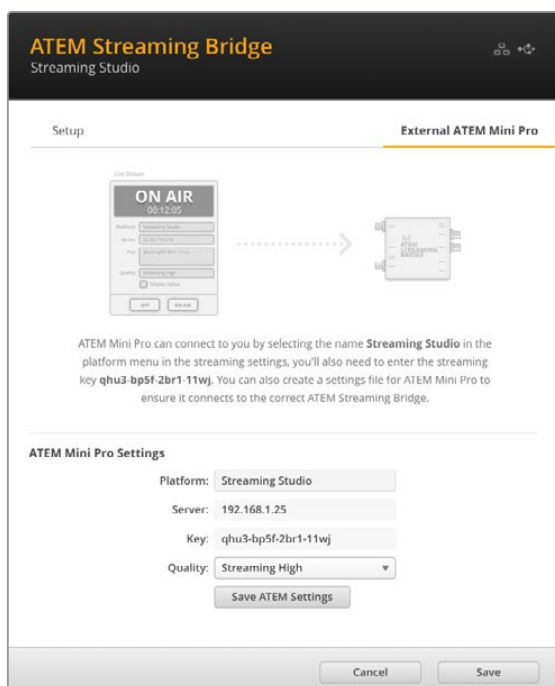

- 2 如要为平台命名, 点击“平台”框, 输入新的名称。该名称会出现在远程Blackmagic设备的平台菜单中。
- 3 选择推流质量。该设置将设定远程Web Presenter的质量。
- 4 点击“Save ATEM Settings” (保存ATEM设置) 按钮, 选择在您计算机上保存XML文件的位置, 然后点击“Save”。
- 5 您现在可以将保存的XML文件通过电子邮件发送给远程操作人员。

提示 您可以使用ATEM Setup中的对讲设置来选择发送回远程Web Presenter的音频通道。

加载XML文件

将设置文件通过电子邮件发送到远程位置后, 远程工作人员只需要使用Blackmagic Web Presenter Setup软件将这个XML文件加载到Web Presenter上, 然后按“ON AIR”就可以开始向演播室进行天气预报推流直播!

请注意, 加载XML推流文件之后, 您每次开始和停止推流直播时都不必再次加载该文件。这样能便于在Web Presenter和ATEM Streaming Bridge之间设置一个固定的视频连接。

只要位于演播室的ATEM Streaming Bridge没有更改其推流设置和网络设置, 并且依然寻找这台Web Presenter进行连接, 它就能始终找到这台Web Presenter, 不论这台Web Presenter在网络中的哪个位置。不论身在何处, 您只要将Web Presenter连接到网络, 按下“ON AIR”按钮, 它就会立即向演播室的ATEM Streaming Bridge推流。

您可以阅读ATEM Mini操作手册了解更多关于如何使用ATEM Streaming Bridge的信息, 手册下载网址: www.blackmagicdesign.com/cn/support

Tally、对讲和摄影机控制

ATEM Streaming Bridge和Blackmagic Web Presenter允许ATEM切换台发送Tally、对讲和摄影机控制信息。这意味着任何基于SDI的Blackmagic Design摄影机都可以被放置在您本地网络的任何位置, 或者通过互联网放置在世界任何地方, 同时仍然拥有Tally、对讲和摄影机控制功能。

设置非常简单。下图显示了如何通过本地网络将URSA Mini Pro 4.6K与ATEM Constellation 8K连接, 获得Tally、对讲和摄影机控制。

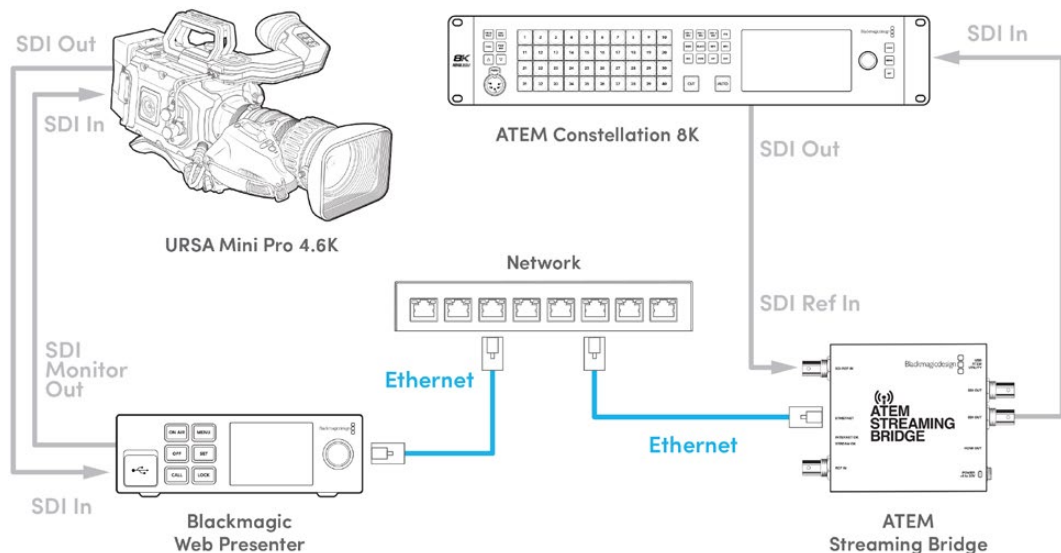

一切连接完毕后:

- 1 按下Blackmagic Web Presenter上的“MENU”按钮, 打开LCD菜单, 前往“Live Stream” (流媒体直播) 菜单。
- 2 在“平台”设置中选择ATEM Streaming Bridge。
- 3 按下“SET”确认。

为保证Tally正常运行, 您需要确保摄影机的ATEM摄影机ID与切换台的输入匹配。更多关于如何设置ATEM摄影机ID的信息, 请参阅URSA Mini操作手册。

您可以在ATEM切换台上把摄影机切换到节目输出, 以此来测试Tally是否运行正常。如果摄影机的ATEM摄影机ID设置正确, Tally灯会亮起, 包括摄影机LCD屏幕一圈的红色Tally边框。然后把摄影机切换到预览输出, Tally会亮绿色。

尝试在ATEM Software Control的摄影机页面调整光圈和黑电平来测试摄影机控制。

内嵌SDI音频通道15和16为默认对讲通道, 但您可以使用ATEM Setup Utility将其修改成工程通道13和14, 或者节目输出。

通过互联网传输时, ATEM Setup Utility会创建XML设置文件。该XML文件会被加载进Blackmagic Web Presenter, 以便在互联网上找到ATEM Streaming Bridge。更多关于如何创建和加载设置XML文件的信息, 请参阅本操作手册中之前的章节。

连接URSA Broadcast G2

URSA Broadcast G2搭载内置推流引擎, 您不需要使用Blackmagic Web Presenter, 因为摄影机可以直接从USB-C扩展端口推流。更多信息, 包括如何设置ATEM摄影机ID让Tally正常运行, 请参阅URSA Broadcast G2操作手册。

Blackmagic Universal Rack Shelf

Blackmagic Universal Rack Shelf是一个1RU机架, 您可以用它把各类Blackmagic Design设备安装在广播机架或航空箱内。它采用模块化设计, 可将容纳于一个机架单位的产品组合成便携式实用型设备组装方案。

下图展示的是安装在小型机架中的3个Universal Rack Shelf机架, 当中安装了一系列兼容设备组合。其中, 底部的机架中间安装了一块1/3机架宽度的挡板, 用于填充设备之间未使用的空间。

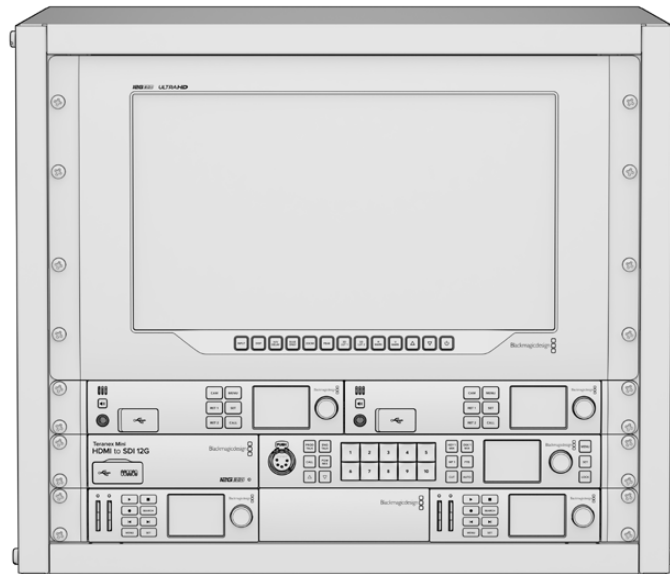

包含组件

Universal Rack Shelf Kit包含以下组件:



1 x Blackmagic Universal Rack Shelf

1RU全宽机架, 可用于安装Blackmagic Design设备。



空白挡板

1 x 1/6机架宽度空白挡板, 2 x 1/3机架宽度空白挡板, 可用于覆盖未使用的机架空间。

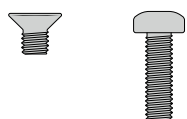
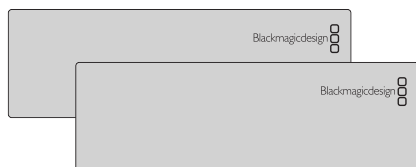

螺丝

12 x M3 5mm规格埋头螺丝。

2 x M3 9mm规格平头螺丝, 用于1/6机架宽度空白挡板。

将设备安装到机架上

- 1 如果安装了橡胶垫, 请使用塑料边缘的刮削工具将橡胶垫从设备底座上移除。
- 2 将机架和设备倒置, 然后将机架的预钻孔与Blackmagic Design设备底座上的螺纹安装孔对齐。1/3机架宽度的设备上设有两个中央安装点, 而较大的1/2机架宽度设备上则设有最多三个安装点。

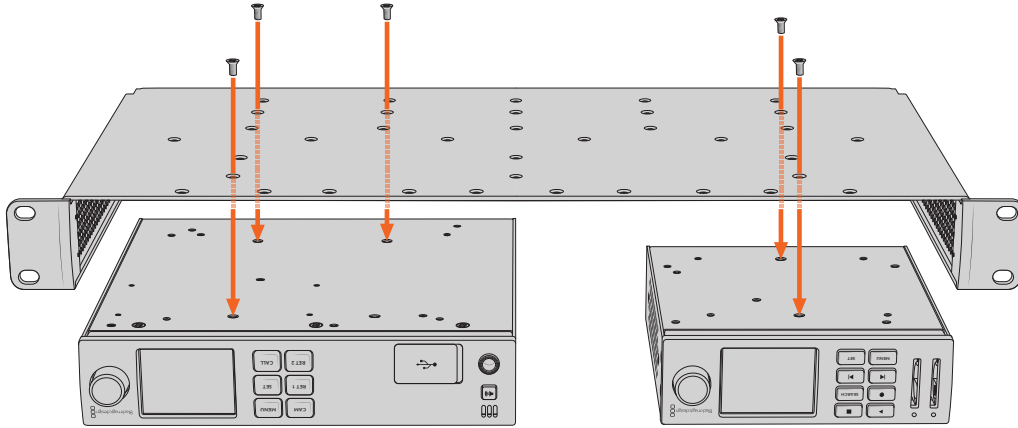

- 3 使用产品内附的M3 5mm埋头螺丝, 将设备固定在机架上。
- 4 固定完成后, 将机架正面朝上放置, 并通过自带的固定支架将其安装到设备机架上。

产品内附的空白挡板可用于覆盖未使用的机架空间。

安装1/6机架宽度空白挡板

尺寸较小的1/6机架宽度空白挡板可在安装1/2机架宽度和1/3机架宽度的设备时用于填充未使用的机架空间。该挡板可安装到任何一台设备的侧面。为了改善空气流通, 建议您将挡板安装在设备之间。

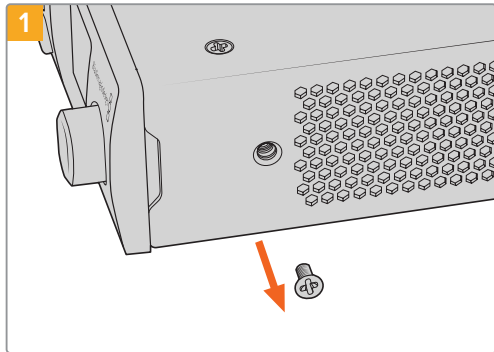

卸下靠近设备正面的5mm M3螺丝。

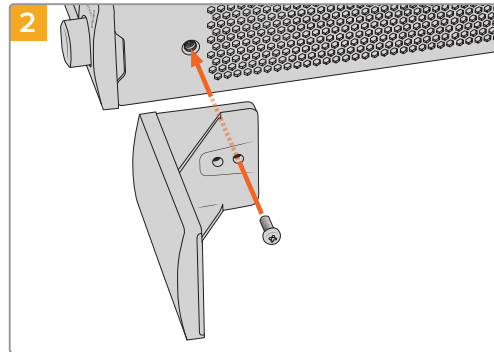

对齐空白挡板, 并使用产品内附的M3 9mm尼龙螺丝进行安装。

安装侧面的1/3机架宽度空白挡板

尺寸较大的1/3机架宽度空白挡板可在安装单台设备时直接安装到机架的任何一侧。在安装空白挡板时, 请将挡板底部的螺孔和锚点与机架对齐, 并使用产品内附的两枚M3 5mm规格埋头螺丝固定到位。

更新内部软件

Blackmagic Web Presenter Setup实用程序可用于更新Web Presenter的内部软件并配置流媒体设置、网络设置以及流媒体质量。

更新内部软件步骤如下：

- 1 登陆网址www.blackmagicdesign.com/cn/support, 下载最新Blackmagic Web Presenter安装程序。
- 2 运行Blackmagic Web Presenter安装程序, 根据屏幕提示完成安装。
- 3 安装完成后, 将Web Presenter通过后面板或前面板塑料防尘盖下的USB端口连接至计算机。
- 4 运行Blackmagic Web Presenter Setup程序, 并根据屏幕提示更新内部软件。如果系统未弹出任何提示信息, 即表示当前内部软件已是最新版本, 无需升级。

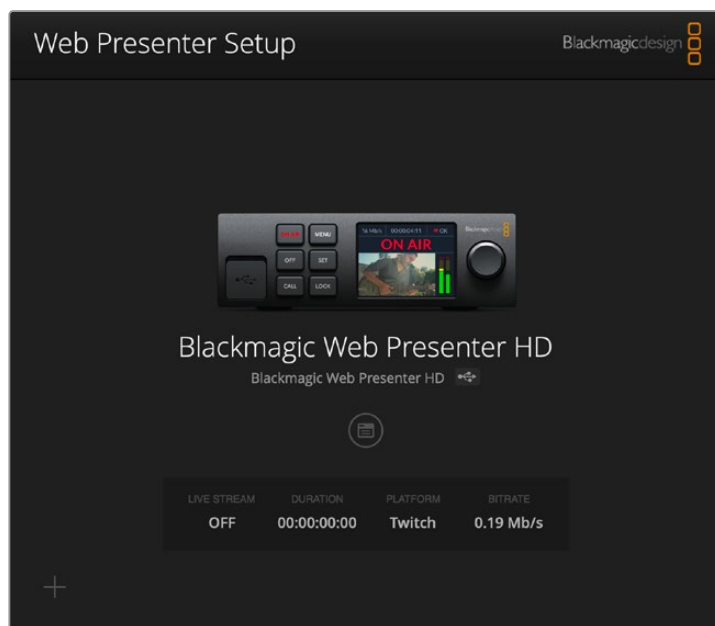

请到Blackmagic Design的支持中心下载最新版操作手册, 网址:
www.blackmagicdesign.com/cn/support。

Developer Information

Blackmagic Web Presenter Ethernet Protocol

v1.2

Protocol Details

Overview

The Blackmagic Web Presenter Ethernet Protocol is a line-oriented, text-based protocol to control a Web Presenter.

Lines from the Web Presenter server will be separated by an ASCII LF sequence.

Messages from the user may be separated by LF or CR LF.

Connection

The Web Presenter server is accessed by connecting to TCP port 9977 on a Web Presenter.

Connection Response

Upon connection, the Web Presenter server sends a dump of the device's state.

The Web Presenter server sends information in blocks, with each having an identifying header followed by a colon. A block spans multiple lines and is terminated by a blank line. Each line in the protocol is terminated by a newline character.

Following the header, a block contains either a single multi-line string or a sequence of key/value pairs arranged one per line. The first full-colon on a line is used to delimit the key and the value. A value may be a comma separated list. In this case, values in the list must have the “,” and “\” characters escaped with a “\” character.

To be resilient to future protocol changes, clients should ignore blocks they do not recognize, up to the trailing blank line. Within recognized blocks, clients should ignore keys they do not recognize.

Legend	
↵	End of line
...	and so on
Orange Text	Client Generated
Grey Text	Server Generated

The protocol preamble block is always the first block sent by the Web Presenter server:

```
PROTOCOL PREAMBLE:↵
Version: 1.2↵
↵
```

The version field indicates the protocol version. When the protocol is changed in a compatible way, the minor version number will be updated. If incompatible changes are made, the major version number will be updated.

The initial status dump is concluded by the end prelude block:

```
END PRELUDE:↵
↵
```

Status Updates

When any device parameter is changed on the Web Presenter server by any client, such as the Blackmagic Web Presenter Setup utility, the Web Presenter server resends the applicable status block, containing only the items that have changed. Status updates can also occur due to external changes such as tethering to a smartphone or when a streaming service is disconnected.

For example, if the input video mode is set to Auto, the following block will be sent:

```
STREAM SETTINGS:↵  
Video Mode: Auto↵  
↵
```

Requesting Changes

To change one or more parameters in a block, the client should send the appropriate block header in the same form the Web Presenter server sends, followed by the key/value pairs to be changed. For example, to change the input video format to 1080p59.94, the user should send the following block:

```
STREAM SETTINGS:↵  
Video Mode: 1080p59.94↵  
↵
```

The block must be terminated by a blank line. On receipt of a blank line, the Web Presenter server will either acknowledge the request by responding:

```
ACK↵  
↵
```

or if unable to parse the block responding with:

```
NACK↵  
↵
```

After a positive response, the client should expect to see a status update from the Web Presenter server showing the status change. This is likely to be the same as the command that was sent, sometimes followed by other blocks providing data specific to the change.

```
STREAM SETTINGS:↵  
Video Mode: 1080p59.94↵  
↵
```

If the Web Presenter server does not understand a key in the requested block, the key will be ignored. If an invalid value is provided for a known key, then the request is ignored and the Web Presenter will respond with the existing value for the key. In both cases the Web Presenter server will still respond with an ACK.

```
STREAM SETTINGS:↵  
Video Mode: UnsupportedMode↵  
↵  
ACK↵  
↵  
STREAM SETTINGS:↵  
Video Mode: 1080p59.94↵  
↵
```

Requesting a Status Dump

The user may request that the Web Presenter server resend the complete state of any status block by sending the block header, followed by a blank line. In the following example, the user requests the Web Presenter server resend the stream settings:

```
STREAM SETTINGS:↵
↵
ACK↵
↵
STREAM SETTINGS:↵
Video Mode: 1080p59.94↵
...
↵
```

Protocol Blocks

Identity Block

The identity block contains information to identify the connected Web Presenter.

Block Syntax

The following example shows the Identity Block for a Blackmagic Web Presenter HD.

```
IDENTITY:↵
Model: Blackmagic Web Presenter HD↵
Label: Blackmagic Web Presenter HD↵
Unique ID: 00112233445566778899AABBCCDDEEFF↵
↵
```

Parameters

Key	Read/Write	Description	Valid Values
Model	Read only	The Web Presenter model name	String
Label	Read/Write	A display name for the Web Presenter	String
Unique ID	Read only	A device specific unique identifier	Hexadecimal ID

Changing Device Label

A device label to identify the Web Presenter can be changed by sending an identity block with label key.

```
IDENTITY:↵
Label: My Web Presenter↵
↵
ACK↵
↵
IDENTITY:↵
Label: My Web Presenter↵
↵
```

Version Block

The version block contains hardware and software version information for the connected Web Presenter.

Block Syntax

```
VERSION:↵  
Product ID: BE73↵  
Hardware Version: 0100↵  
Software Version: 0123ABCD↵  
Software Release: 3.3↵  
↵
```

Parameters

Key	Read/Write	Description	Valid Values
Product ID	Read only	The Web Presenter product ID	Hexadecimal ID
Hardware Version	Read only	The Web Presenter hardware version	Hexadecimal version
Software Version	Read only	The Web Presenter software version	Hexadecimal version
Software Release	Read only	The Web Presenter software release version	Version Number

Network Blocks

The network block contains the TCP/IP networking configuration for the connected Web Presenter.

Block Syntax

This example shows the output for a connected Web Presenter. It displays 2 networking interfaces - the Gigabit Ethernet interface and option for a tethered smartphone.

The network settings prefixed with Current show the active TCP/IP settings, and are read-only. The Current settings reflect either the DHCP or Static configuration, depending on the Dynamic IP flag.

```
NETWORK:↵  
Interface Count: 2↵  
Default Interface: 0↵  
↵  
NETWORK INTERFACE 0:↵  
Name: Ethernet↵  
Priority: 1↵  
MAC Address: 00:11:22:33:44:55↵  
Dynamic IP: true↵  
Current Addresses: 192.168.1.10/255.255.255.0↵  
Current Gateway: 192.168.1.1↵  
Current DNS Servers: 192.168.1.1, 8.8.8.8, 8.8.4.4↵  
Static Addresses: 10.0.0.2/255.255.255.0↵  
Static Gateway: 10.0.0.1↵  
Static DNS Servers: 8.8.8.8, 8.8.4.4↵  
↵
```

```

NETWORK INTERFACE 1:↵
Name: USBEthernet↵
Priority: 0↵
MAC Address: 00:00:00:00:00:00↵
Dynamic IP: true↵
Current Addresses: 0.0.0.0/255.255.0.0↵
Current Gateway: 0.0.0.0↵
Current DNS Servers: ↵
Static Addresses: 10.0.0.2/255.255.255.0↵
Static Gateway: 10.0.0.1↵
Static DNS Servers: 8.8.8.8, 8.8.4.4↵
↵

```

Parameters

Network Block

Key	Read/Write	Description	Valid Values
Interface Count	Read only	The number of networking interfaces supported by the Web Presenter	Integer
Default Interface	Read only	The default networking interface	Integer

Network Interface Block

Key	Read/Write	Description	Valid Values
Name	Read only	The name of the networking interface	String
Priority	Read/Write	The priority of the network interface. When multiple network interfaces are available, the high priority interface will become the default	Unsigned integer. The higher number is the higher priority
MAC Address	Read Only	MAC address of the networking interface	IEEE 802 MAC address
Dynamic IP	Read/Write	Selects DHCP or Static IP configuration	true - DHCP enabled false - Static IP
Current Addresses	Read Only	The current IP address and Subnet mask	{IPv4 address}/{Subnet Mask}
Current Gateway	Read Only	The current IP gateway address	IPv4 address
Current DNS Servers	Read only	The IP addresses of the current DNS servers	Comma separated list of IPv4 addresses
Static Addresses	Read/Write	Status IP address and subnet mask when DHCP disabled	{IPv4 address}/{Subnet Mask}
Static Gateway	Read/Write	Static gateway address when DHCP disabled	IPv4 address
Static DNS Servers	Read/Write	The IP addresses of the static DNS servers	Comma separated list of IPv4 addresses

Changing Networking Settings

The network can be configured to use either DHCP or a static configuration. To enable DHCP on Network Interface 0:

```
NETWORK INTERFACE 0:↵
```

```
Dynamic IP: true↵
```

```
↵
```

```
ACK↵
```

```
↵
```

```
NETWORK INTERFACE 0:↵
```

```
Dynamic IP: true↵
```

```
↵
```

To set a fixed IP address, supply all static parameters:

```
NETWORK INTERFACE 0:↵
```

```
Dynamic IP: false↵
```

```
Static Addresses: 192.168.1.2/255.255.255.0↵
```

```
Static Gateway: 192.168.1.1↵
```

```
Static DNS Servers: 8.8.8.8, 8.8.4.4↵
```

```
↵
```

```
ACK↵
```

```
↵
```

```
NETWORK INTERFACE 0:↵
```

```
Dynamic IP: false↵
```

```
Static Addresses: 192.168.1.2/255.255.255.0↵
```

```
Static Gateway: 192.168.1.1↵
```

```
Static DNS Servers: 8.8.8.8, 8.8.4.4↵
```

```
↵
```

Changing network settings may cause the IP connection to be dropped.

UI Settings Block

The UI settings block contains the front panel LCD and monitor output settings for the connected Web Presenter.

Block Syntax

```
UI SETTINGS:↵
```

```
Available Locales: en_US.UTF-8, zh_CN.UTF-8, ja_JP.UTF-8, ko_KR.UTF-8, es_
ES.UTF-8, de_DE.UTF-8, fr_FR.UTF-8, ru_RU.UTF-8, it_IT.UTF-8, pt_BR.UTF-8,
tr_TR.UTF-8, pl_PL.UTF-8, uk_UA.UTF-8↵
```

```
Current Locale: en_US.UTF-8↵
```

```
Available Audio Meters: PPM -18dB, PPM -20dB, VU -18dB, VU -20dB↵
```

```
Current Audio Meter: PPM -20dB↵
```

```
↵
```

Parameters

Key	Read/Write	Description	Valid Values
Available Locales	Read only	The locales available in the Web Presenter	Comma separated list of locales
Current Locale	Read/Write	The current locale for Web Presenter	Refer to the locales from the Available Locales field
Available Audio Meters	Read only	The available audio meters supported by the Web Presenter	Comma separated list of audio meter types
Current Audio Meter	Read/Write	The current audio meter	Refer to the audio meters from the Available Audio Meters field

Stream Settings Block

The stream settings block contains the stream configuration for the connected Web Presenter.

Block syntax

This example shows the output for a connected Web Presenter. The stream settings prefixed with Current show the active stream settings and are writable. The stream settings prefixed by Available show the available stream settings for the device or platform and are read-only. To view the available servers or quality levels for a stream service, the Current Platform stream setting should be set first.

```
STREAM SETTINGS:↵
Available Video Modes: Auto, 1080p23.98, 1080p24, 1080p25, 1080p29.97,
1080p30, 1080p50, 1080p59.94, 1080p60, 720p25, 720p30, 720p50, 720p60↵
Video Mode: 1080p59.94↵
Current Platform: YouTube↵
Current Server: Primary↵
Current Quality Level: Streaming Medium↵
Stream Key: abc1-def2-ghi3-jkl4-mno5↵
Password: ↵
Current URL: srt://192.168.8.51
Customizable URL: true
Available Default Platforms: YouTube RTMP, YouTube SRT (Beta), Facebook,
Twitch, Twitter, Restream.IO, Vimeo, BoxCast, CastR, AfreecaTV, Bilibili,
DouYu, Weibo↵
Available Custom Platforms: My Platform↵
Available Servers: Primary, Secondary↵
Available Quality Levels: HyperDeck High, HyperDeck Medium, HyperDeck Low,
Streaming High, Streaming Medium, Streaming Low↵
↵
```

Parameters

Key	Read/Write	Description	Valid Values
Available Video Modes	Read only	The video modes available in the Web Presenter	Comma separated list of video modes
Video Mode	Read/Write	The current video mode	Refer to the video modes from the <i>Available Video Modes</i> field
Current Platform	Read/Write	The selected streaming platform	Refer to the platforms from the <i>Available Default Platforms</i> and <i>Available Custom Platforms</i> fields
Current Server	Read/Write	The current server for the streaming platform	Server is dependent on selected Current Platform
Current Quality Level	Read/Write	The current streaming quality level	Quality level is dependent on selected Current Platform
Stream Key	Read/Write	The stream key for the streaming platform	String
Password	Read/Write	The passphrase for an encrypted SRT stream	String
Current URL	Read/Write	The current URL for the streaming platform. This field is writable if <i>Customizable URL</i> field is true.	String
Customizable URL	Read only	A boolean specifying whether custom URLs are supported by the streaming platform	true - Custom URLs are supported false - Custom URLs are not supported
Available Default Platforms	Read only	The available default streaming platforms	Comma separated list of default platforms
Available Custom Platforms	Read only	The custom streaming platforms loaded in the Web Presenter	Comma separated list of custom platforms
Available Servers	Read only	The available servers for the selected streaming platform	Comma separated list of servers
Available Quality Levels	Read only	The available quality levels for the selected streaming platform	Comma separated list of quality levels

Changing Stream Settings

The stream settings can be changed by providing a stream settings block. The following is an example of streaming a 1080p59.94 input on Twitch with a medium stream quality.

```

STREAM SETTINGS:↵
Video Mode: 1080p59.94↵
Current Platform: Twitch↵
Current Server: US West: Los Angeles, CA↵
Current Quality Level: Streaming Medium↵
Stream Key: live_123456789_1aB2cD3eF4gH5iJ6kL7mN8oP9qR0sT↵
↵
ACK↵
↵
STREAM SETTINGS:↵
Video Mode: 1080p59.94↵
Current Platform: Twitch↵
Current Server: US West: Los Angeles, CA↵
Current Quality Level: Streaming Medium↵
Stream Key: live_123456789_1aB2cD3eF4gH5iJ6kL7mN8oP9qR0sT↵
↵

```

Stream XML Block

The stream XML block allows users to configure the Web Presenter with a custom configuration file in XML format.

Block syntax

The following example shows an XML file - Custom.xml has been loaded to configure the stream settings in the Web Presenter.

```
STREAM XML:↵  
Files: Custom.xml↵  
↵
```

Parameters

Key	Read/Write	Description	Valid Values
Files	Read/Write	The XML files loaded in Web Presenter	Comma separated list of filenames
Action	Write only	The stream XML action	Remove Remove All

Adding a Stream XML file

An XML file can be loaded onto a Web Presenter by sending the stream xml command with a filename, then provide the contents of the XML file. After adding the XML file, the Available Custom Platforms field in the STREAM SETTINGS block will be updated with the new platforms, however the Current items will remain unchanged.

For the Stream XML block to be parsed correctly, any blank lines should be removed from the XML files.

Refer to the `Blackmagic Stream XML File Format` section in this manual for description of the Stream XML file format.

```
STREAM XML Custom.xml:↵  
<?xml version="1.0" encoding="UTF-8"?>↵  
<streaming>↵  
    <service>↵  
        <name>My Custom Platform</name>↵  
        ...  
    </service>↵  
</streaming>↵  
↵  
ACK↵  
↵  
STREAM XML Custom.xml:↵  
<?xml version="1.0" encoding="UTF-8"?>↵  
<streaming>↵  
    <service>↵  
        <name>My Custom Platform</name>↵  
        ...  
    </service>↵  
</streaming>↵  
↵
```



```
STREAM XML:↵
Files: Custom.xml↵
↵
STREAM SETTINGS:↵
Available Custom Platforms: My Custom Platform↵
↵
```

Removing a Stream XML file

An XML file can be removed from the Web Presenter by sending the stream xml command with the remove action.

```
STREAM XML:↵
Action: Remove↵
Files: Custom.xml↵
↵
ACK↵
↵
STREAM XML:↵
Files:↵
↵
STREAM SETTINGS:↵
Available Custom Platforms:↵
↵
```

Removing all Stream XML files

All XML files can be removed from the Web Presenter by sending the stream xml command with the remove all action. In the example, following the remove all action, the loaded stream XML files and available custom platforms are both displayed as empty.

```
STREAM XML:↵
Action: Remove All↵
↵
ACK↵
↵
STREAM XML:↵
Files: ↵
↵
STREAM SETTINGS:↵
Available Custom Platforms:↵
↵
```

Stream State Block

The stream state block provides the streaming status of the Web Presenter.

The Web Presenter server will send a stream state block update whenever there is a change to the Status field. Due to frequency of changes to Duration, Bitrate and Cache Used fields, these fields need to be polled by the client by requesting a Stream State block.

Block syntax

```
STREAM STATE:↵↵
Status: Idle↵↵
Bitrate: 161672↵↵
Duration: 00:00:00:00↵↵
Cache Used: 0↵↵
↵↵
```

Parameters

Key	Read/Write	Description	Valid Values
Status	Read only	The stream state of the Web Presenter, updated when the stream status changes	Idle Connecting Streaming Interrupted
Action	Write only	The Web Presenter stream state action.	Start Stop
Duration	Read only	The duration of the active stream	String in format of DD:HH:MM:SS
Bitrate	Read only	The bitrate of the active stream	Integer bits per second
Cache Used	Read only	The current usage of the streaming cache	Integer as a percentage

Starting Stream

The stream is started by providing a stream state block with start action.

```
STREAM STATE:↵↵
Action: Start↵↵
↵↵
ACK↵↵
↵↵
STREAM STATE:↵↵
Status: Connecting↵↵
↵↵
STREAM STATE:↵↵
Status: Streaming↵↵
↵↵
```

Stopping stream

The stream is stopped by providing a Stream State block with stop action.

```
STREAM STATE:↵↵
Action: Stop↵
↵
ACK↵
↵
STREAM STATE:↵↵
Status: Idle↵
↵
```

Audio Settings Block

The Audio Settings block contains the audio configuration for the connected Web Presenter.

Block syntax

This example shows the output for a connected Web Presenter. The stream settings prefixed with Current show the active audio settings and are writable. The stream settings prefixed by Available show the available audio settings for the device or platform and are read-only.

```
AUDIO SETTINGS:↵↵
Current Monitor Out Audio Source: Auto↵
Available Monitor Out Audio Sources: Auto, SDI In, Remote Source↵
↵
```

Parameters

Key	Read/Write	Description	Valid Values
Current Monitor Out Audio Source	Read/Write	The current audio source on the monitor output	Refer to the audio sources from the <i>Available Monitor Out Audio Sources</i> field
Available Monitor Out Audio Sources	Read only	The available audio sources that can be routed to the monitor output	Comma separated list of audio sources

Changing Audio Settings

The audio settings can be changed by providing an audio settings block. The following is an example of setting the monitor output audio source to remote.

```
AUDIO SETTINGS:↵↵
Current Monitor Out Audio Source: Remote Source↵
↵
ACK↵
↵
AUDIO SETTINGS:↵↵
Current Monitor Out Audio Source: Remote Source↵
↵
```

Shutdown Block

The Shutdown block provides power control of the Web Presenter. The Shutdown block is write-only and not presented in the preamble.

Parameters

Key	Read/Write	Description	Valid Values
Action	Write only	The Web Presenter shutdown action.	Reboot Factory Reset

Reboot

The Web Presenter can be rebooted by providing a Shutdown block with reboot action.

```
SHUTDOWN:↵
```

```
Action: Reboot↵
```

```
↵
```

```
ACK↵
```

```
↵
```

On reboot action, the Web Presenter server will be stopped and clients will be disconnected.

Factory Reset

The Web Presenter can be factory reset by providing a Shutdown block with factory reset action. On factory reset action, all settings are set to factory defaults.

```
SHUTDOWN:↵
```

```
Action: Factory Reset↵
```

```
↵
```

```
ACK↵
```

```
↵
```

Blackmagic Streaming XML Format

Overview

The Blackmagic Streaming XML allows users to specify streaming services in addition to the default services provided by the Web Presenter.

The Streaming XML can be loaded into the Web Presenter with Web Presenter Setup. Refer to the 'Using Web Presenter Setup' section earlier in this manual

The Streaming XML can also be loaded by copying the contents into the Stream XML block with the Blackmagic Web Presenter Ethernet Protocol.

The following is a minimal example of a Streaming XML file:

```
<?xml version="1.0" encoding="UTF-8"?>
<streaming>
  <service>
    <name>My Streaming Service</name>
    <servers>
      <server>
        <name>My Streaming Server</name>
        <url>rtmp://my.streaming-server.com/live</url>
      </server>
    </servers>
    <profiles>
      <profile>
        <name>My Streaming Quality</name>
        <config resolution="1080p" fps="60" codec="H264">
          <bitrate>7500000</bitrate>
        </config>
      </profile>
    </profiles>
  </service>
</streaming>
```

Streaming XML Definition

The Streaming XML file follows standard XML format and shall begin with XML declaration.

```
<?xml version="1.0" encoding="UTF-8"?>
```

Streaming Element

The Streaming XML file shall be contained by the <streaming> element. The <streaming> element will consist of 1 or more <service> child elements.

The following is an example of a <streaming> element block that defines 2 streaming services.

```
<streaming>
  <service>
    <name>Service 1</name>
    <!-- Streaming settings for "Service 1" -->
  </service>
  <service>
    <name>Service 2</name>
    <!-- Streaming settings for "Service 2" -->
  </service>
</streaming>
```

Service Element

The <service> element provides a description of the streaming service. If multiple streaming services are used, it is possible to define multiple <service> elements within each <streaming> element block.

The following is an example of a <service> element block in the Stream XML file.

```
<streaming>
  <service customizable-url="true">
    <name>My Streaming Service</name>
    <key>abc1-def2-ghi3-jkl4-mno5</key>
    <servers>
      <!-- Streaming server settings -->
    </servers>
    <profiles default="Streaming High">
      <!-- Streaming quality settings-->
    </profiles>
    <credentials>
      <!-- Streaming username and password settings -->
    </credentials>
  </service>
  <!-- <service> elements blocks for other streaming services -->
</streaming>
```

Attributes

Attribute	Optional/Required	Description
customizable-url	Optional	The service supports specifying custom URLs - supported = "true" or unsupported = "false" (default)

Child Elements

Element	Optional/Required	Description
<name>	Required	The name of the streaming service
<key>	Optional	The stream key for the streaming service
<servers>	Optional	The RTMP/SRT server settings of the streaming service (see below). May be omitted if customizable-url is true.
<profiles>	Required	The quality settings of the streaming service (see below)
<credentials>	Optional	The username and password of the streaming service (see below)

Servers Element

The <servers> element consists of 1 or more <server> child elements for defining the streaming server(s). The <servers> element is a required child of the <service> element. Defining multiple servers allows specifying localized and/or backup servers within a single XML description

The following is an example of a <servers> element block that defines a primary and secondary URL for the SRT server.

```
<service>
  ...
  <servers>
    <server group="Primary">
      <name>My Streaming Service Server</name>
      <url>srt://srt.my-streaming-service.com:2010</url>
      <srt-extensions>
        ...
      </srt-extensions>
    </server>
    <server group="Secondary">
      <name>My Streaming Service Backup Server</name>
      <url>srt://srt-backup.my-streaming-service.com:2010</url>
      <srt-extensions>
        ...
      </srt-extensions>
    </server>
    <!-- Additional <server> element blocks defining other
servers for streaming service -->
  </servers>
  ...
</service>
```

Attributes

Attribute	Optional/Required	Description
group	Optional	The logical grouping for the server

Child Elements

Element	Optional/Required	Description
<name>	Required	The name of the RTMP/SRT streaming server
<url>	Required	The URL of the RTMP/SRT streaming server
<srt-extensions>	Optional	Extended service block specific to SRT streaming server (see below)

SRT Extensions Element

The <srt-extensions> element consists of 1 or more child elements that define SRT specific parameters.

The following is an example of a <srt-extensions> element block for a primary stream identifier.

```
<service>
  ...
  <servers>
    <server group="Primary">
      ...
      <srt-extensions>
        <stream-id>
          <item key="copy" value="0"/>
        </stream-id>
      </srt-extensions>
    </server>
  </servers>
  ...
</service>
```

Child Elements

Element	Optional/Required	Description
<stream-id>	Required	Provides element with custom parameters for the stream ID. Each child element of stream-id has 1 or more item elements with a key/value pair.

Profiles Element

The <profiles> element consists of 1 or more <profile> child elements that define streaming quality. The <profiles> element is a required child of the <service> element. Defining multiple profiles allows specifying custom bitrates for different streaming qualities.

The following is an example of a <profiles> element block that defines 3 profiles.

```
<service>
  ...
  <profiles default="Streaming High">
    <profile>
      <name>Streaming High</name>
      <!-- Define <config> elements to specify target
bitrates for Streaming High profile -->
    </profile>
    <profile>
      <name>Streaming Medium</name>
      <!-- Define <config> elements to specify target
bitrates for Streaming Medium profile -->
    </profile>
  </profiles>
  ...
</service>
```

Attributes

Attribute	Optional/Required	Description
default	Optional	The name of the default profile

Child Elements

Element	Optional/Required	Description
<name>	Required	The name of the profile
<config>	Required	Video mode dependent quality settings for profile (see below)

Config Element

The <config> element defines a mapping between the video resolution and frame rate and the target bitrate for the quality level. The <config> element is a child of the <profile> element.

The following is an example of a <config> element block for setting the target bitrate for a high quality stream with 720p60 and 1080p60 video inputs.

```
<profile>
  <name>Streaming High</name>
  <config resolution="720p" fps="60" codec="H264">
    <bitrate>6000000</bitrate>
    <audio-bitrate>128000</audio-bitrate>
  </config>
  <config resolution="1080p" fps="60" codec="H264">
    <bitrate>8000000</bitrate>
    <audio-bitrate>128000</audio-bitrate>
  </config>
  <!-- <config> elements for other resolutions and frame rates -->
</profile>
```

Attributes

Attribute	Optional/Required	Description
resolution	Required	The resolution of the streaming video mode
fps	Required	The frame rate of the streaming video mode (frames per second)
codec	Optional	The codec for encoding the streaming video - "H264" (default) or "H265"

Child Elements

Element	Optional/Required	Description
<bitrate>	Required	The target bitrate of the streaming video (bits per second)
<audio-bitrate>	Optional	The target bitrate of the streaming audio (bits per second)

The supported streaming quality bitrates can be found in section `Using Web Presenter Setup` section earlier in this manual.

TIP For each <config> element block, choose a maximum resolution and fps to cover all video modes for the target bitrate. For example, defining a <config> element with resolution="1080p" and fps = "30" will apply for video modes 1080p23.98, 1080p24, 1080p25, 1080p29.97 and 1080p30.

For audio bitrate, only 128 Kb/s is supported.

Credentials Element

The <credentials> element allows specifying an RTMP session username and password if required by the service. The <credentials> element is an optional child to service element.

The following is an example of a <credentials> element block that defines a username and password for the streaming service.

```
<service>
  ...
  <credentials>
    <username>myusername</username>
    <password>abcd1234</password>
  </credentials>
  ...
</service>
```

Child Elements

Element	Optional/Required	Description
<username>	Required	RTMP session username
<password>	Required	RTMP/SRT session password

帮助

获得帮助

获得帮助最快捷的方法是登陆Blackmagic Design在线支持页面, 浏览Blackmagic Web Presenter的相关最新支持材料。

Blackmagic Design在线支持页面

请登陆Blackmagic Design支持中心www.blackmagicdesign.com/cn/support获得最新操作手册。

Blackmagic Design论坛

您可以登陆我们网站访问Blackmagic Design论坛, 获得更多信息和有用的创意资源。访问论坛也是获取帮助的一个捷径, 因为论坛中不乏经验丰富的用户和Blackmagic Design的员工, 他们都能为您答疑解惑。论坛地址: <https://forum.blackmagicdesign.com>

联系Blackmagic Design支持中心

如果我们提供的支持信息和论坛均无法解答您的疑问, 请到支持页面下点击“给我们发送电子邮件”按钮即可发送技术支持请求。或者, 您也可以点击支持页面下的“查找您所在地区的支持团队”按钮, 致电您所在地区的Blackmagic Design支持中心获得帮助。

监管声明



在欧盟范围内处置电子垃圾和电子设备的注意事项。

根据产品所附的提示标志, 本设备不得与其它废弃材料共同处置。处置废弃设备时, 必须交给指定收集点进行回收。对废弃设备进行单独收集并回收能够节省自然资源, 且回收方式不会损害环境和人体健康。获取更多关于废弃设备回收点的信息, 请联系您所在城市的回收站, 或当时购买设备的经销商。



本设备经过测试, 符合FCC规则的第15部分对A类数字设备的限制。这些限制旨在为运行于商业环境中的设备提供合理保护, 使其免受有害干扰的影响。本设备可生成、使用且辐射射频能量, 如果未按照安装手册来安装和使用本设备, 则可能导致对无线电通信的有害干扰。在住宅区运行本产品可能会产生有害干扰, 在这种情况下将由用户自行承担消除干扰的费用。

必须满足以下条件后方可操作:

- 1 设备不会造成有害干扰。
- 2 设备必须接受任何受到的干扰, 包括可能导致意外操作的干扰。



R-R-BMD-20201201001
R-R-BMD-20201201002

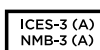

加拿大ISED认证声明

本设备符合加拿大A类数码产品的相关标准。

任何对本产品的改装或预期用途之外的使用均可能导致相关标准认证无效。

必须使用有高品质屏蔽的HDMI电缆连接HDMI接口。

本设备经检测符合商业环境使用要求。在家用环境中, 本设备可能会造成无线电干扰。

安全信息

设备必须连接在配有保护地线的电源插座。

为了降低触电风险, 请勿将设备放在会滴水或溅水的地方。

设备适合在环境温度低于40°C的热带地区使用。

存储温度范围为-20°C到60°C, 相对湿度为0%到90%不结露。

确保设备四周留有足够的空间, 不受阻碍。

安装在机架上时, 确保相邻设备不会阻碍通风。

设备内部没有操作人员可维护的零件。维修服务请联系当地Blackmagic Design服务中心。



请在海拔高度2000米以下的地区使用。

加利福尼亚安全声明

该产品可能会让您暴露在塑料部件中所含的微量多溴化联苯等化学物质下, 此类物质已被加州政府认定为可能导致癌症、先天畸形或其他遗传危害的物质。

详情请访问网址: www.P65Warnings.ca.gov

保修

36个月有限保修

Blackmagic Design保证Blackmagic Web Presenter转换器自购买之日起36个月内不会有材料和工艺上的缺陷；自购买之日起12个月内，接口、线缆、光纤模块、保险丝、及电池不会出现材料或工艺上的缺陷。若本产品在其保修期内出现质量问题，Blackmagic Design可选择为产品提供免费修理或更换零部件，或者更换缺陷产品。

为确保消费者有权享受本保修条款中的服务，如遇产品质量问题请务必在保修期内联系Blackmagic Design并妥善安排保修事宜。消费者应将缺陷产品包装并运送到Blackmagic Design的指定服务中心进行维修，运费由消费者承担并预先支付。若消费者因任何原因退货，所有运费、保险费、关税等各项税务以及其他费用均由消费者承担。

本保修条款不适用于任何因使用、维护不当或保养不周造成的缺陷、故障或损坏。根据本保修服务，Blackmagic Design的保修服务范围不包括以下内容：1. 对由非Blackmagic Design专门人员进行的安装、维修或保养所造成的损坏进行维修，2. 对因使用不当或连接到不兼容设备所造成的损坏进行维修，3. 对因使用了非Blackmagic Design生产的零部件所导致的损坏或故障进行维修，及 4. 对经过改装或和其他产品进行组装的产品进行保养维修（因为产品经改装或组装后会增加保养维修所需时间或保养难度）。本保修条款由BLACKMAGIC DESIGN提供，它可取代所有其他明示或隐含的保修。BLACKMAGIC DESIGN及其供应商对任何有关适销性及就特定用途的适用性等隐含保证不作任何担保。BLACKMAGIC DESIGN负责为消费者提供缺陷产品的维修或更换服务是完整和排他性补救措施，不论BLACKMAGIC DESIGN或其供应商是否事先获悉发生间接、特殊、偶然或必然损坏等损坏的可能性。若消费者对本设备进行非法使用，BLACKMAGIC DESIGN概不负责。对因使用本产品造成的损失，BLACKMAGIC DESIGN概不负责。本产品的操作风险由用户自行承担。

© 版权所有 2023 Blackmagic Design。保留一切权利。“Blackmagic Design”、“DeckLink”、“HDLink”、“Workgroup Videohub”、“Multibridge Pro”、“Multibridge Extreme”、“Intensity”以及“Leading the creative video revolution”均为美国及其他国家的注册商标。所有其他公司名称及产品名称可能是其他所有者的注册商标。

Thunderbolt及其商标为英特尔公司在美国和/或其他国家的商标。

Blackmagic Web Presenter





환영합니다.

Blackmagic Web Presenter를 구매해 주셔서 감사합니다.

Blackmagic Web Presenter는 모든 SDI 장비에 직접 연결할 수 있으며, 신호를 H.264로 변환하여 유튜브 라이브 및 페이스북 라이브, 트위치와 같은 인기 스트리밍 서비스에서 스트리밍할 수 있습니다. 옵션 제품인 ATEM Streaming Bridge를 함께 사용하여 방송 품질의 영상을 원하는 지점으로 전송할 수도 있습니다. 이를 통해 전문 영상을 인터넷을 통해 원하는 장소로 쉽게 전송해 보세요!

본 설명서는 Blackmagic Web Presenter를 처음 사용 시 알아야 할 모든 사항과 유튜브 라이브, 페이스북 라이브, 트위치, 줌, 스카이프 등에 대한 설정 방법 등 모든 기능 및 컨트롤을 사용하는 방법에 대해 소개합니다.

또한 이 설명서의 최신 버전과 Blackmagic Web Presenter의 내부 소프트웨어에 대한 업데이트는 당사 웹사이트 www.blackmagicdesign.com/kr의 고객 지원 페이지에서 확인하실 수 있습니다. 소프트웨어를 다운로드할 때 사용자 정보를 등록하시면 새로운 소프트웨어가 출시될 때마다 업데이트 소식을 받아보실 수 있습니다.

앞으로도 새로운 기능 및 제품 향상을 위해 끊임없이 노력하며 고객 여러분의 다양한 의견을 기다리겠습니다.

A handwritten signature in black ink that reads "Grant Petty". The signature is written in a cursive, flowing style.

Blackmagic Design의 CEO,

그랜트 패티

목차

시작하기	323
Web Presenter의 전면 패널 사용하기	326
LCD 디스플레이	327
모니터링 출력 사용하기	328
Web Presenter Setup 사용하기	333
라이브 스트리밍(Live Stream) 탭	334
설정(Setup) 탭	337
네트워크 설정하기	338
다이렉트 스트리밍을 위한 인터넷 공유 설정	338
스마트폰을 사용하여 스트리밍 하기	339
Blackmagic Web Presenter HD의 웹캠 출력 사용하기	339
Open Broadcaster 설정하기	339
ATEM Streaming Bridge로 비디오 링크 생성하기	342
XML 파일 생성하기	343
XML 파일 보내기	343
탈리, 토크백, 카메라 컨트롤	344
URSA Broadcast G2 연결하기	345
Blackmagic Universal Rack Shelf	346
목차	346
랙 선반에 장비 설치하기	347
1/6 블랭킹 패널 장착하기	347
측면 1/3RU 블랭킹 패널 장착하기	347
내부 소프트웨어 업데이트	348
Developer Information	349
Blackmagic Web Presenter Ethernet Protocol	349
Protocol Blocks	351
Blackmagic Streaming XML Format	362
Overview	362
Streaming XML Definition	362
도움말	369
규제 사항	370
안전 정보	371
보증	372

시작하기

Blackmagic Web Presenter는 쉽고 빠르게 설치하여 사용할 수 있습니다. 간단히 전원을 연결하고 비디오 및 오디오를 연결한 뒤, Blackmagic Web Presenter를 컴퓨터에 연결하고 인터넷에 연결하면 됩니다.

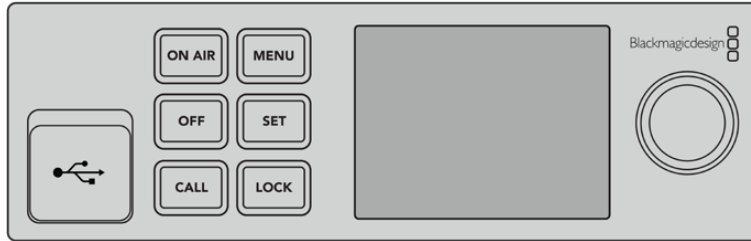

Blackmagic Web Presenter 전면 패널 모습

전원 연결하기

Blackmagic Web Presenter의 뒷면 패널에 있는 전원 입력 단자에 표준 IEC 전원 케이블을 연결하세요.

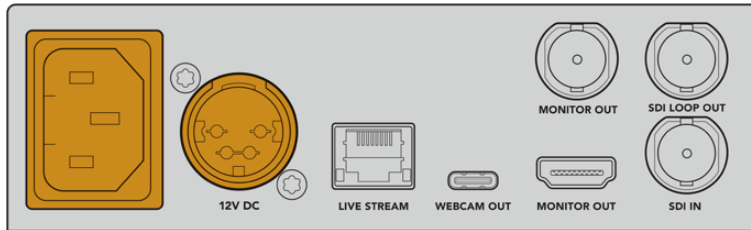

Blackmagic Web Presenter는 IEC 또는 12V DC 전원 입력 단자를 통해 전원을 공급받습니다.

Web Presenter에는 12V DC 전원 입력 단자가 추가로 탑재되어 있습니다. 또한 12V DC 입력을 사용해 외부 전원을 연결하거나 전원 공급 장치(UPS) 또는 12V 외장 배터리 외부 전원과 같은 외부 전원 장치를 통해 리던던시 전원을 연결할 수 있습니다.

비디오 및 오디오 연결하기

Blackmagic Web Presenter의 SDI 입력에 소스 비디오를 연결하세요. 비디오가 연결되면 Web Presenter HD의 내장 LCD 화면에 연결 상태가 표시됩니다. 오디오는 비디오에 임베딩되어 SDI 비디오 신호와 함께 전송되며, 이를 LCD 화면의 오디오 미터를 통해 확인할 수 있습니다.

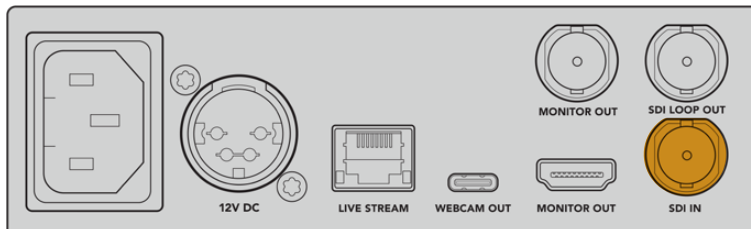

사용하려는 비디오를 Blackmagic Web Presenter의 SDI 입력 단자에 연결하세요.

Blackmagic Web Presenter는 12G-SDI를 지원하며 비디오 입력이 변경될 시, 최대 2160p60의 HD 및 UHD 사이의 포맷으로 자동 변환합니다. Blackmagic Web Presenter 4K는 UHD 스트리밍을 지원하며 Blackmagic Web Presenter HD 모델은 거의 모든 영상 신호를 받아 1080p로 변환시킵니다.

모니터에 연결하기

HDMI TV 또는 SDI 모니터를 Web Presenter HD의 모니터 출력 단자 중 하나에 연결하세요. 이를 통해 사용자의 방송 영상을 모니터링 하고 비디오 스트리밍과 관련하여 수시로 변경되는 주요 상태 정보를 확인할 수 있습니다. 모니터 출력 단자 사용에 대한 자세한 정보는 본 설명서의 [모니터 출력 사용하기] 부분을 참고하세요.

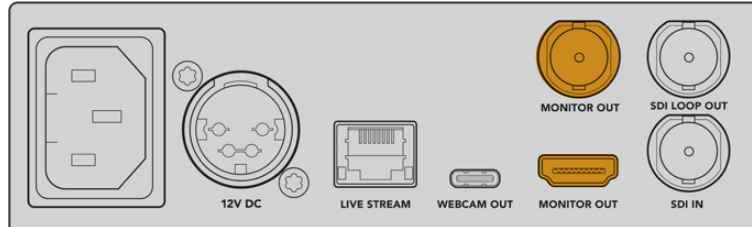

모니터를 Web Presenter HD의 모니터 출력 단자에 연결하세요.

USB를 사용하여 컴퓨터에 연결하기

Web Presenter의 전면 또는 뒷면 패널에 있는 USB-C 포트를 사용하여 컴퓨터에 연결하세요. USB 포트는 Web Presenter의 업데이트 및 Blackmagic Web Presenter Setup 유틸리티를 사용하여 설정할 때 사용합니다. 처음에 한 번 Web Presenter의 설정을 완료하고 나면, 컴퓨터와의 연결을 해제해도 됩니다.

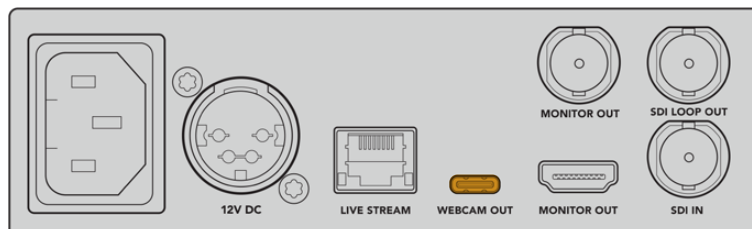
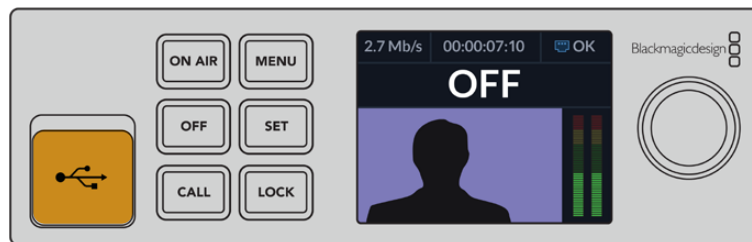

Blackmagic Web Presenter의 전면 또는 뒷면 패널에 있는 USB 포트를 사용하여 컴퓨터에 연결하세요.

인터넷에 연결하기

Blackmagic Web Presenter의 LIVE STREAM 이더넷 포트에 네트워크 케이블을 꽂고 이를 인터넷 라우터 또는 네트워크 스위처로 연결하여 인터넷에 연결하세요.

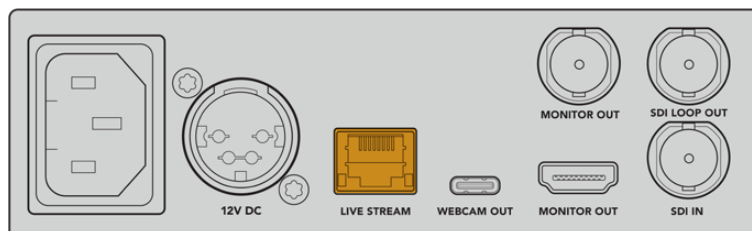

Blackmagic Web Presenter의 뒷면 패널에 있는 이더넷 포트를 사용하여 네트워크에 연결하세요.

라이브 스트리밍 설정하기

이제 유튜브 라이브, 페이스북 라이브, 트위치 등의 원하는 스트리밍 플랫폼으로 영상을 스트리밍하도록 Web Presenter를 설정할 수 있습니다. 아래에서는 유튜브 라이브로 스트리밍하는 것을 예로 들어 설명합니다.

- 1 사용자의 '유튜브 스튜디오' 계정에서 스트림 키를 복사하세요.
- 2 www.blackmagicdesign.com/kr/support에서 Blackmagic Web Presenter Setup 유틸리티를 다운로드 한 후, 컴퓨터에 설치하세요. 이 소프트웨어는 처음에만 한 번 스트리밍 설정을 해주면 됩니다.
- 3 Blackmagic Web Presenter Setup 유틸리티를 연 뒤, 'Live Stream' 페이지로 들어가세요.
- 4 플랫폼을 'YouTube'로 설정하고 서버를 'Primary'로 설정하세요. 복사했던 스트림 키를 'Key' 필드에 붙여넣고 스트리밍 화질을 선택하세요. 'Save' 버튼을 클릭하세요.
- 5 이제 전 세계 원하는 곳이 어디든 스트리밍할 수 있습니다! 'ON AIR' 버튼을 클릭하거나, 웹 프리젠티어의 전면 패널에 있는 ON AIR 버튼을 누르세요. 프로덕션을 완료한 후에는 OFF 버튼을 눌러 방송을 중지하세요.

SRT 스트리밍 프로토콜 사용하기

SRT(Secure Reliable Transport) 프로토콜은 RTMP에 비해 지연 현상이 낮은 스트리밍을 지원합니다. SRT는 또한 암호 키와 같은 패스프레이즈 사용을 통해 보안성을 향상시킵니다.

스트리밍 서비스에서 SRT 프로토콜 버전 선택 시, 사용하는 스트리밍 계정에서 패스프레이즈와 스트림 키를 복사하여 Blackmagic Web Presenter Setup 유틸리티의 'Key'와 'Passphrase' 입력란에 붙여넣기 하세요.

The screenshot shows a 'Live Stream' configuration window. It contains the following fields and controls:

- Platform: YouTube SRT (Beta) (dropdown menu)
- Server: Primary (dropdown menu)
- Key: 3ec3-qhu3-bp5f-2br1-11wj (text input field)
- Passphrase: pp-e000-3ec3-0369-2b19 (text input field)
- Quality: Streaming Medium (dropdown menu)
- Buttons: OFF and ON AIR (toggle buttons)

유틸리티 'Passphrase' 입력란에 패스프레이즈를 붙여넣기 하세요.

기술 관련 경험을 가진 방송국 관계자가 스트리밍 서비스 설정을 변경하려는 경우, XML 파일에서 프로토콜 RTMP 또는 SRT뿐만 아니라, 코덱 H.264 또는 H.265 또한 변경할 수 있습니다. 더욱 자세한 정보는 [Blackmagic 스트리밍 XML 포맷]을 확인하세요.

Web Presenter의 전면 패널 사용하기

Blackmagic Web Presenter의 전면 패널 컨트롤을 사용하여 스트리밍의 시작/정지 및 설정을 변경할 수 있습니다.

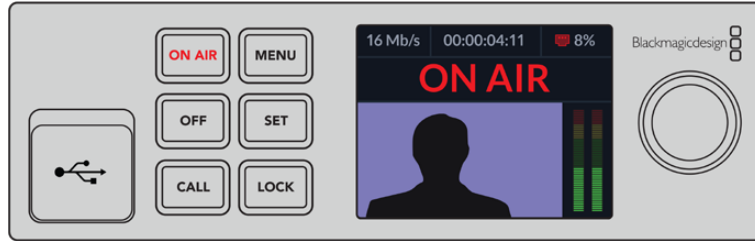

ON AIR - 스트리밍을 시작하려면 ON AIR 버튼을 누르세요. 스트리밍 중에는 버튼에 빨간색 불이 들어옵니다.

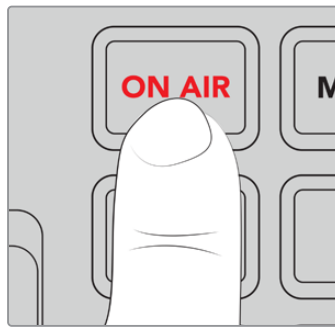

ON AIR 버튼이 깜박이는 것은 실시간 스트리밍이 시작되지 않았거나 예기치 않게 정지되었음을 나타냅니다. 이는 인터넷 연결 또는 스트리밍 설정 때문일 수 있습니다. 인터넷 연결이 제대로 작동하며 스트리밍 설정이 올바른지 확인하세요.

OFF - 스트리밍을 중지하려면 OFF 버튼을 누르세요.

MENU - LCD의 설정 메뉴에 접속하려면 MENU 버튼을 누르세요.

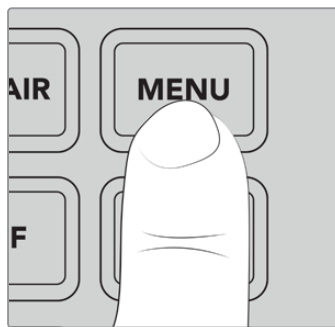

설정 변경하기

- 1 회전 노브를 사용하여 원하는 사항을 선택하고 SET 버튼을 눌러 실행하세요.



- 2 노브를 돌려 설정을 변경하세요.
- 3 SET 버튼을 눌러 위의 설정을 적용하세요.

MENU 버튼을 눌러 메뉴 항목을 뒤로 이동하며 시작 화면으로 되돌아 갑니다.

CALL - 이 기능은 향후 업데이트를 통해 사용할 수 있습니다.

LOCK - 패널을 잠그려면 LOCK 버튼을 1초간 누르세요. 그러면 버튼이 비활성화 되어 실수로 버튼을 눌러 방송을 하거나 스트리밍이 중단되는 것을 방지할 수 있습니다. 이 버튼을 사용 중일 시 버튼에 빨간불이 들어옵니다.



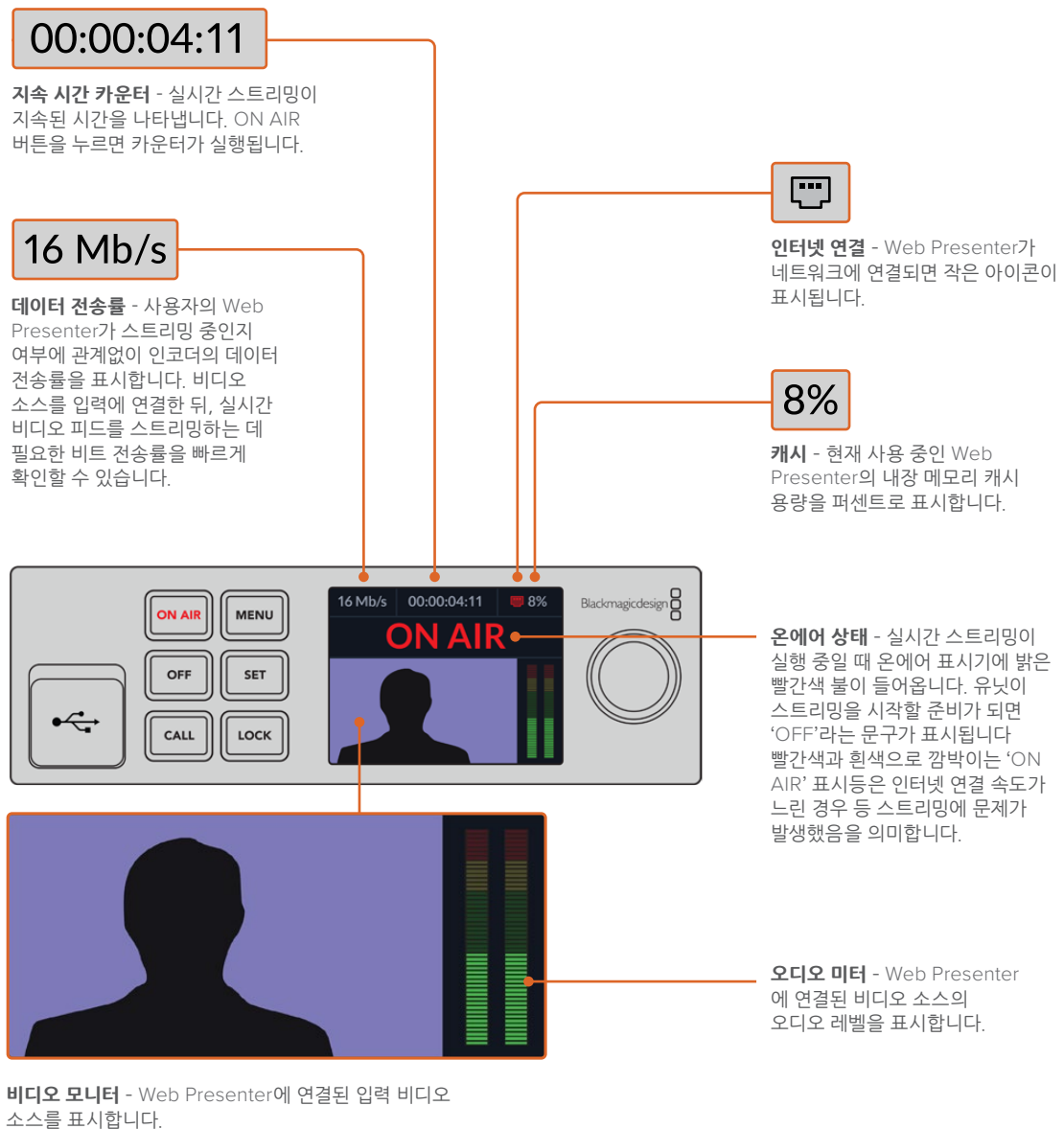

패널의 잠금을 해제하기 위해서는 LOCK 버튼을 2초간 누르세요.

LCD 디스플레이

시작 화면은 Web Presenter의 전원을 켤 때 가장 먼저 보게 되는 화면입니다. 시작 화면에서는 다음과 같은 정보를 확인할 수 있습니다.



인터넷 연결 아이콘

	이더넷 케이블이 연결되면 파란색 이더넷 아이콘이 표시되어 스트리밍 시 이더넷 연결이 사용될 예정임을 나타냅니다.
	이더넷을 통해 방송중인 상태로 스트리밍 중일 때 빨간색 이더넷 아이콘이 표시됩니다.
	테더링된 스마트폰의 인터넷 데이터를 이용하여 스트리밍을 할 예정인 경우 파란색 스마트폰 아이콘이 표시됩니다.
	테더링된 스마트폰을 통해 방송중 및 스트리밍 시 빨간 스마트폰 아이콘이 표시됩니다.

정보 아이콘이 표시되지 않으면 Web Presenter가 네트워크에 연결되지 않은 것입니다.

모니터링 출력 사용하기

모니터 출력을 통해 비디오 입력, 오디오 레벨, 방송 상태, 데이터 전송률 및 캐시 레벨, SDI 입력에 관한 기술 정보를 모니터링할 수 있습니다.



Blackmagic Web Presenter의 모니터 출력은 데이터 전송률 및 캐시 상태를 포함한 포괄적인 정보를 제공합니다.

모니터 출력 디스플레이는 8개의 패널로 구성되어 있습니다. 다음은 각 패널에 대한 설명과 표시되는 정보입니다.

입력 뷰

메인 패널은 연결된 SDI 비디오 소스의 현재 비디오 입력을 표시합니다.



온에어 상태 정보

스트리밍 전에는 이 상태 정보에 'OFF'가 표시되며 Web Presenter가 대기 중으로 방송 준비가 완료되었음을 나타냅니다. 스트리밍이 시작되면 이 표시가 밝은 빨간색의 'ON AIR'으로 바뀌며, 스트리밍이 정지될 때까지 이 표시가 지속됩니다.

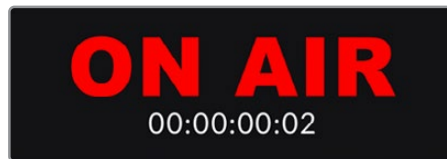

온에어 표시 밑에 있는 지속 시간 카운터는 Web Presenter에서 ON AIR 버튼을 누를 때 실행됩니다.

Web Presenter가 방송 중이 아니지만 테더링된 스마트 폰을 통해 스트리밍되는 경우, 'OFF'가 표시되는 모서리에 파란색 스마트폰 아이콘이 표시됩니다. 방송중인 경우 스마트폰 아이콘에 빨간불이 들어옵니다.

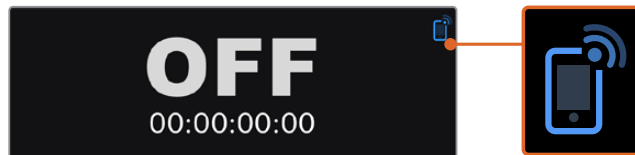

라이브 스트리밍

라이브 스트리밍 패널에는 실시간 스트리밍 설정 정보가 표시됩니다. 표시되는 정보에는 스트리밍 플랫폼, 서버, 프로토콜, 스트리밍 표준, 화질, 스트리밍 해상도 및 품질 설정 또한 표시됩니다.

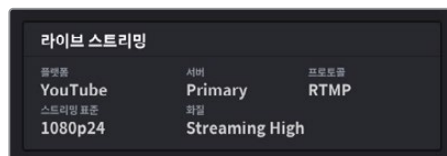

비디오 입력

비디오 입력 패널 상단에 있는 5개의 미니 뷰어는 6초 전의 실시간 스트리밍 내용을 표시하며, 각 소형 뷰어는 스트리밍 1.2초 동안의 영상을 나타냅니다.

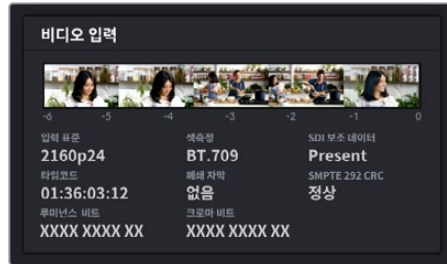

미니 뷰어 아래에서 Web Presenter의 SDI 입력에 연결된 비디오 입력 소스에 대한 자세한 기술 정보를 볼 수 있습니다.

입력 표준	SDI 비디오 입력의 해상도 및 프레임 레이트를 표시합니다. Web Presenter는 최대 2160p60까지 지원합니다.
색측정	SDI 비디오 입력의 색공간을 표시합니다. Web Presenter는 Rec.601 및 Rec.709, Rec.2020 색공간을 지원합니다.
SDI 보조 데이터	보조 데이터는 SDI 비디오 입력으로 전달되는 영상 이외의 데이터입니다. 이 데이터는 임베딩된 오디오, 타임 코드 및 폐쇄 자막을 포함합니다. SDI 입력에 보조 데이터가 포함된 경우, 'Present'로 표시됩니다.
타임 코드	SDI 비디오 입력 소스의 타임 코드를 표시합니다.
폐쇄 자막	SDI 비디오 입력에 폐쇄 자막이 포함된 경우 포맷이 여기에 표시됩니다. CEA-608 및 CEA-708 포맷이 지원됩니다.
SMPTE 292 CRC	SDI 비디오에 오류가 있는지 확인하는 기능입니다. Web Presenter가 SDI 비디오 입력에서 문제를 감지하면 오류가 표시됩니다. CRC 오류는 일반적으로 결함이 있는 SDI 케이블이나 너무 긴 케이블로 인해 발생합니다.
루미넌스 Y 비트 및 크로마 비트	<p>'루미넌스 Y 비트' 및 '크로마 비트' 표시는 SDI 비디오 입력 신호의 활동을 보여줍니다. 각 문자는 비디오 신호의 비트 하나의 상태를 나타냅니다.</p> <p>X - 'X'는 지속적으로 변하는 비트를 나타냅니다.</p> <p>L - 낮은 비트를 나타냅니다.</p> <p>H - 높은 비트를 나타냅니다.</p> <p>SDI 오프셋 정보는 이해하기 쉽도록 생략됩니다. 예를 들어, 화면이 검은색으로 나타나면 모든 비트는 낮은 비트가 됩니다.</p> <p>일반적으로 SDI 비디오 입력의 모든 10비트는 'X'로 표시되어 비디오 스트리밍의 모든 비트가 지속적으로 변경됨을 나타냅니다. SDI 입력이 8 비트 비디오인 경우 오른쪽 끝의 두 비트는 데이터가 없기 때문에 항상 'L'로 표시됩니다. 'X' 표시를 예상했는데 'L' 또는 'H'로 나타난다면 이는 비트가 막혔다는 것을 나타내며, 이는 업스트림 동영상의 오류로 인한 것일 수 있습니다.</p>

오디오 입력

오디오 입력 패널 상단의 오디오 파형 디스플레이에는 실시간 스트리밍된 영상의 지난 6초 동안의 오디오 정보가 표시됩니다. 이 정보는 지속적으로 업데이트되며 오른쪽에서 왼쪽으로 움직입니다.

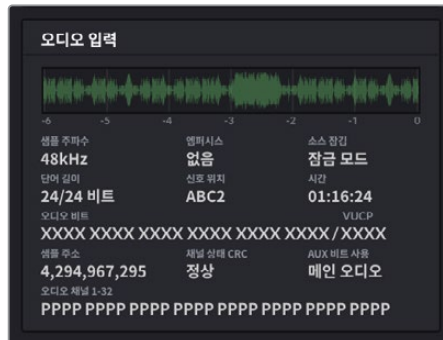

오디오 파형 디스플레이 아래에서 오디오 입력에 대한 자세한 기술 정보를 볼 수 있습니다.

샘플 주파수	SDI 입력에 임베딩된 오디오의 샘플 주파수 속도를 표시합니다.
엠펜시스	오디오 소스에 엠펜시스 옵션이 활성화되어 있는지 여부를 나타냅니다.
오디오 소스 잠금	오디오 소스 주파수가 외부 레퍼런스 소스에 잠겨 있는지를 나타냅니다.
단어 길이	SDI 입력에 임베딩된 오디오의 비트 깊이를 표시합니다.
신호 위치	이 4개 문자는 채널 신호 위치를 나타냅니다.
시각	소스 입력 시각을 나타냅니다
오디오 비트	SDI 연결에 임베딩된 오디오 샘플의 비트 활동 상태 정보를 나타냅니다. 오디오 채널 상태에서 16, 20, 24 비트 오디오를 사용 중이라고 나타나도 오디오 비트 활동 정보가 이를 확인합니다.
VUCP	왼쪽에서 오른쪽으로 VUCP 비트를 읽습니다. 'V' 비트는 유효, 'U'는 사용자 비트, 'C'는 '채널 상태' 비트, 'P'는 패리티를 나타냅니다. 이 필드는 '오디오 비트'와 유사합니다.
샘플 주소	오디오 샘플 카운터
AUX 비트 사용	AUX 비트가 메인 오디오에 사용되는지를 나타냅니다.
오디오 채널 1-32	각 숫자는 SDI 입력에 임베딩된 오디오 채널을 나타냅니다. 'P'는 오디오 채널이 사용 중임을 나타내고 ' '는 해당 채널에 오디오가 없음을 의미합니다.

데이터 전송률 표시

데이터 전송률 디스플레이는 지난 60초 동안의 인코더 데이터 속도를 보여줍니다. 데이터 전송률은 초당 메가비트(Mb/s) 단위로 측정됩니다. 이 표시는 방송중이 아닌 경우에도 일관되게 실행되므로 방송을 시작하기 전에 대역폭을 정확하게 가능할 수 있습니다.

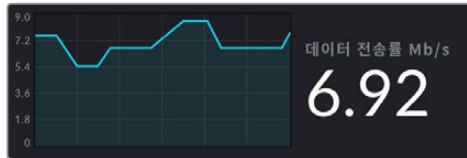

캐시 디스플레이

캐시 디스플레이에는 Web Presenter에서 현재 사용 중인 내장 메모리 버퍼 비율이 표시되며, 지난 60초 동안 사용된 메모리 용량이 그래프에 표시됩니다. 캐시는 작은 용량의 내부 메모리로서, 프로그램 출력을 지속적으로 녹화 및 재생합니다. 스트리밍 데이터 속도가 비디오 전송을 지속하기 어려운 수준 아래로 떨어질 경우, 캐시가 안전장치의 역할을 합니다.

인터넷은 주로 네트워크 활동이나 무선 신호 강도의 영향을 받아 변수가 많습니다. 따라서 방송 데이터 속도가 감소할 경우에는 이 버퍼 데이터가 그에 맞게 증가합니다. 연결 속도가 감소하여 비디오 스트리밍이 불가능할 정도가 될 경우 캐시가 비디오 프레임을 보완합니다. 하지만 캐시가 100%로 가득 차게 되면 비디오 스트리밍이 이에 따라 영향을 받게 되므로, 가능하면 캐시가 가득 차는 것을 방지해야 합니다. 스트리밍을 시작하지 않고도 비디오 피드를 연결하고 모니터 출력의 캐시 디스플레이를 보면서 시험해 볼 수 있습니다. 캐시가 자주 100%가 되면 스트리밍 설정에서 더 낮은 화질을 선택하세요.

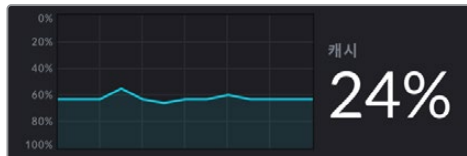

오디오 미터

오디오 미터를 사용하여 오디오 소스의 레벨을 모니터링할 수 있습니다. 메뉴 설정을 통해 Web Presenter에서 PPM 또는 VU 레벨을 표시하도록 설정할 수 있습니다. 오디오 레벨이 너무 높으면 미터에 빨간불이 들어오며 라이브 스트리밍의 오디오가 왜곡되거나 클리핑될 수 있음을 나타냅니다. 오디오를 녹색 상단 부분까지 유지하는 것을 권장하지만 가끔씩 노란색 부분까지 사용 가능합니다.

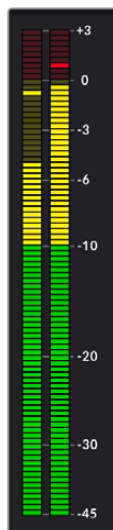

Web Presenter Setup 사용하기

Blackmagic Web Presenter가 네트워크에 연결되어 있으면 동일한 네트워크에 연결된 컴퓨터를 사용하여 Web Presenter를 원격으로 제어할 수 있습니다. Blackmagic Web Presenter Setup을 사용하면 전면 패널과 동일한 컨트롤 및 설정에 접속할 수 있습니다.

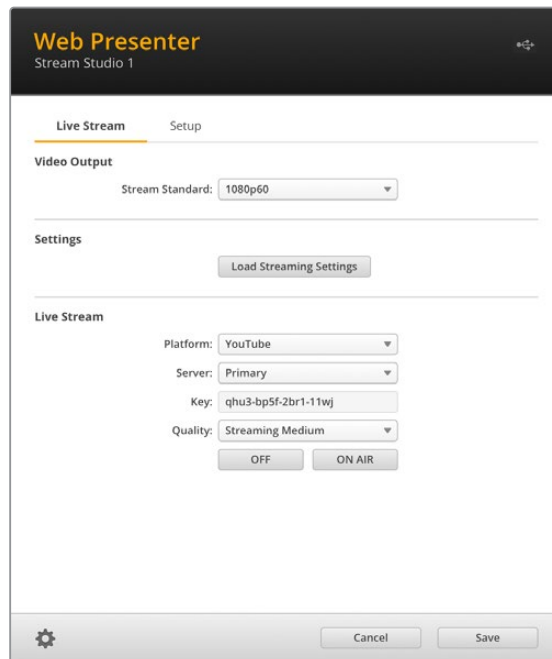
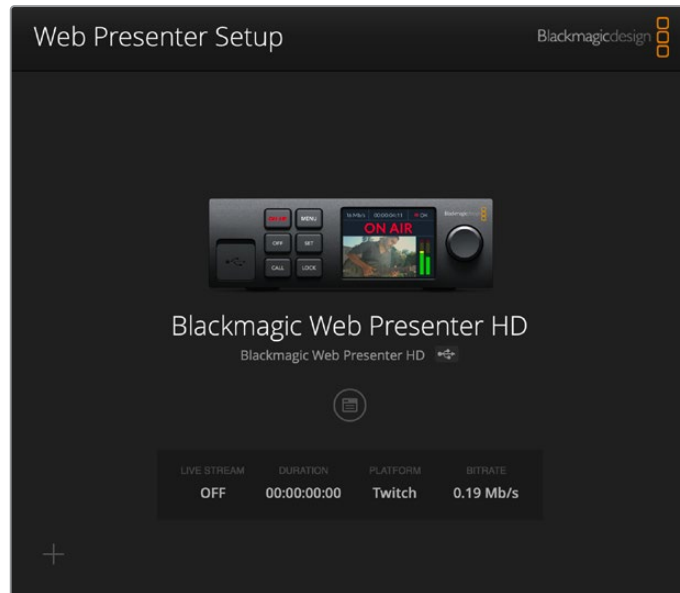

라이브 스트리밍(Live Stream) 탭

비디오 출력(Video Output)

스트리밍 표준(Stream Standard)

'Stream Standard' 메뉴를 클릭하여 스트리밍 비디오 해상도를 선택하세요. 사용하는 Web Presenter 모델에 따라 720p25에서 최대 1080p60 또는 2160p60까지 선택할 수 있습니다.

설정(Settings)

Blackmagic ATEM Streaming Bridge의 XML 파일과 같이 사용자 지정 스트리밍 설정이 있는 경우, 'Load Streaming Settings(스트리밍 설정 불러오기)' 항목을 클릭하여 설정을 가져올 수 있습니다.

사용자 지정 설정 생성 및 ATEM Streaming Bridge 연결에 대한 자세한 내용은 이 설명서 뒷부분의 [ATEM Streaming Bridge로 비디오 링크 생성하기] 부분을 참고하세요.

라이브 스트리밍(Live Stream)

플랫폼(Platform)

'플랫폼' 메뉴 목록을 클릭한 뒤 방송에 사용할 스트리밍 플랫폼을 선택하세요. 유튜브, 페이스북, 트위치 등의 옵션을 선택할 수 있습니다. 사용자 지정 스트리밍 설정을 가져온 경우, 해당 설정이 플랫폼 목록에도 나타납니다.

커스텀 URL로 스트리밍하려면, '플랫폼' 메뉴에서 커스텀 URL 옵션을 선택하세요. Web Presenter 4K에서는 H.264 또는 H.265를 사용하여 커스텀 URL에 스트리밍하도록 선택할 수 있으며, Web Presenter HD에서는 H.264를 사용하여 스트리밍할 수 있습니다.

서버(Server)

현재 사용지 위치에서 가장 가까운 서버를 목록에서 선택하세요. 서버 목록은 선택한 스트리밍 플랫폼에 따라 달라집니다.

Instagram, Microsoft Teams, 커스텀 URL에 스트리밍할 경우엔 서버 목록을 수정할 수 있습니다. 사용하는 스트리밍 플랫폼 계정에 지정된 URL 또는 커스텀 URL 정보를 입력하세요.

키(Key)

스트리밍 플랫폼에서 할당받은 스트림 키를 입력하세요.

패스프레이즈(Passphrase)

스트리밍 서비스에서 SRT 스트리밍 프로토콜을 사용하는 경우, 사용 중인 스트리밍 플랫폼 계정에 지정된 패스프레이즈를 입력하세요.

화질(Quality)

사용하는 Web Presenter 모델에 따라 HD 또는 4K를 위한 스트리밍 화질을 선택할 수 있습니다.

H.264	
HD	4K
HyperDeck High(HyperDeck 높음) 45~70 Mb/s	HyperDeck High(HyperDeck 높음) 95~220 Mb/s
HyperDeck Medium(HyperDeck 중간) 25~45 Mb/s	HyperDeck Medium(HyperDeck 중간) 66~150 Mb/s
HyperDeck Low(HyperDeck 낮음) 12~20 Mb/s	HyperDeck Low(HyperDeck 낮음) 38~80 Mb/s
Streaming High(스트리밍 높음) 6~9 Mb/s	Streaming High(스트리밍 높음) 34~51 Mb/s
Streaming Medium(스트리밍 중간) 4.5~7 Mb/s	Streaming Medium(스트리밍 중간) 23~35 Mb/s
Streaming Low(스트리밍 낮음) 3~4.5 Mb/s	Streaming Low(스트리밍 낮음) 13~20 Mb/s

H.265	
HD	4K
Streaming High(스트리밍 높음) 2.3~4.5 Mb/s	Streaming High(스트리밍 높음) 22.5~30 Mb/s
Streaming Medium(스트리밍 중간) 1.5~3 Mb/s	Streaming Medium(스트리밍 중간) 14~20 Mb/s
Streaming Low(스트리밍 낮음) 0.8~2 Mb/s	Streaming Low(스트리밍 낮음) 8~10 Mb/s

화질 설정에서 사용 가능한 데이터율은 Web Presenter에서 운영 중인 비디오 표준에 따라 달라집니다. 예를 들어, 'Streaming High(스트리밍 높음)' 옵션을 선택하고 1080p24로 운영하는 경우, 6 Mb/s의 데이터 전송률이 적용됩니다.

위 표를 보면 스트리밍 데이터율이 HyperDeck 레이트에 비해 낮은 것을 확인할 수 있습니다. 이는 일반적으로 인터넷 데이터 전송률이 디스크 녹화 데이터보다 낮은 대역폭을 가지기 때문입니다.

각 설정에서는 2가지 데이터 전송률이 제공됩니다. 24p/25p/30p의 낮은 프레임 속도의 경우, 낮은 값의 데이터 전송률을 사용하며, 50p/60p의 높은 프레임 속도를 사용하는 경우에는 높은 데이터 전송률이 사용됩니다. 스트리밍 화질은 'Streaming High(스트리밍 높음) 6~9 Mb/s로 기본 설정되어 있으며, 매우 높은 화질의 스트리밍 채널을 제공합니다.

OFF 및 ON AIR 버튼 사용하기

OFF 및 ON AIR 버튼을 사용하여 라이브 스트리밍을 시작하거나 중지할 수 있습니다. 라이브 스트리밍이 진행 중이면 ON AIR 버튼에 빨간불이 켜집니다.

불러온 설정 제거하기

Web Presenter로 불러오기 한 모든 스트리밍 설정을 제거하려면, '라이브 스트리밍' 탭 좌측 하단에 있는 톱니 아이콘을 클릭하세요. '제거'를 클릭해 선택을 확인하세요.

오디오 탭

오디오 탭에서는 Web Presenter의 오디오 모니터링 출력과 오디오 미터 설정 옵션을 사용할 수 있습니다.

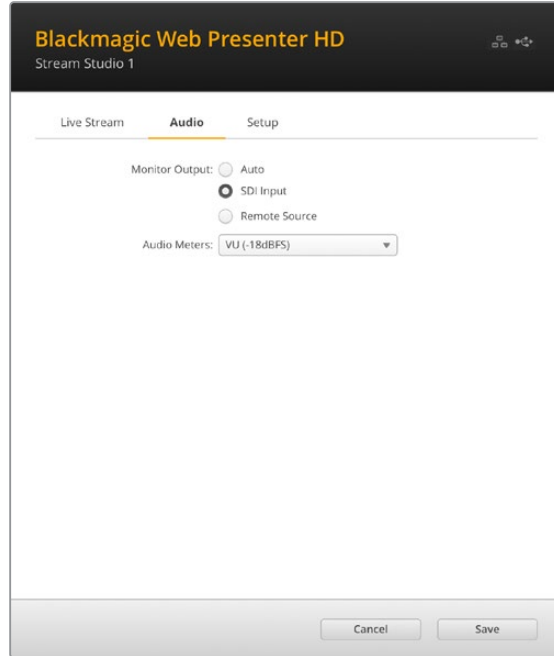

모니터 출력

모니터 출력 옵션을 사용하여 Web Presenter의 SDI 및 HDMI 모니터링 출력에 사용할 오디오 소스를 선택하세요.

자동

모니터 출력이 '자동'으로 설정되면 ATEM Streaming Bridge를 통해 ATEM Switcher로부터 전송되는 토크백 오디오를 Web Presenter가 자동으로 감지하여 모니터링합니다. 감지된 토크백이 없을 시에는 SDI 입력의 오디오가 사용됩니다.

SDI 입력

예를 들어, Blackmagic Studio Camera같이 Web Presenter의 SDI 입력 소스에서 전송되는 오디오를 모니터링하려면 'SDI 입력'을 선택하세요.

원격 소스

원격 ATEM 스위치 또는 ATEM Streaming Bridge에서 전송되는 토크백 오디오를 모니터링하려면 이 옵션을 사용하세요.

오디오 미터

메뉴를 사용하여 표시할 오디오 미터 유형을 선택하세요. VU -18dBFS, VU -20dBFS, PPM -18dBFS, PPM -20dBFS 레퍼런스 레벨 중에서 원하는 옵션을 선택할 수 있습니다.

설정(Setup) 탭

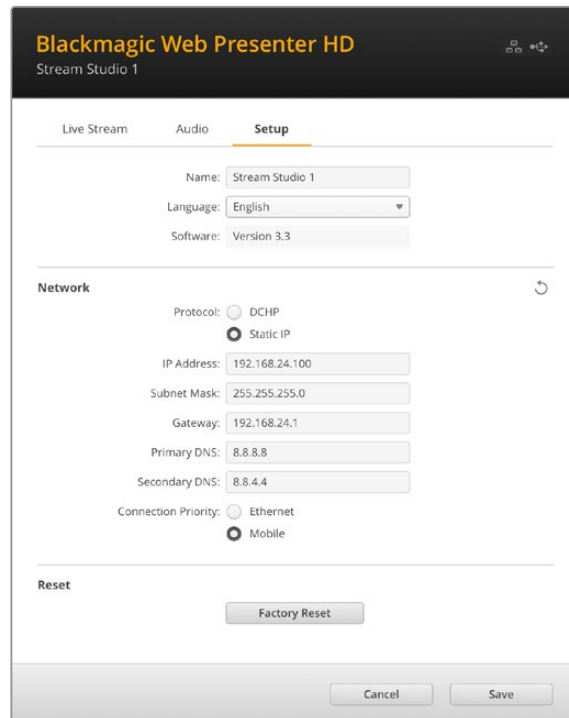

이름(Name)

Web Presenter의 이름을 바꾸려면 입력란에 새 이름을 입력하고 'Save'를 클릭하세요.

언어(Language)

Web Presenter HD의 언어 설정을 변경할 수 있습니다.

소프트웨어(Software)

Web Presenter의 현재 소프트웨어 버전을 표시합니다.

오디오 미터(Audio Meters)

메뉴를 사용하여 표시할 오디오 미터 유형을 선택하세요. VU -18dBFS, VU -20dBFS, PPM -18dBFS 또는 PPM -20dBFS 레퍼런스 레벨 중에서 선택하세요.

네트워크(Network)

네트워크 설정을 통해 DHCP를 통한 네트워크 연결 또는 고정 IP 주소 사용 중에서 선택하는 옵션을 선택할 수 있습니다. Web Presenter를 네트워크에 연결하는 방법에 대한 자세한 내용은 [네트워크 설정하기] 부분을 참고하세요.

연결 우선 순위(Connection Priority) - 이더넷과 휴대폰이 모두 Web Presenter에 연결되어 있는 경우, 이 설정을 통해 스트리밍에 사용할 연결을 선택할 수 있습니다. 모바일 테더링에 대한 자세한 내용은 [스마트폰을 사용하여 스트리밍 하기] 부분을 참고하세요.

초기화(Reset)

'Factory Reset' 항목을 클릭하면 Web Presenter가 초기화됩니다.

네트워크 설정하기

고정 IP 주소 또는 DHCP를 사용하여 Web Presenter를 네트워크에 연결할 수 있습니다.

DHCP - 사용하는 장치의 IP 주소를 자동으로 설정하여 다른 설정 변경없이 네트워크에 연결합니다.

DHCP(Dynamic Host Configuration Protocol)는 자동으로 Web Presenter를 검색하여 IP 주소를 지정하는 네트워크 서버 및 라우터의 서비스를 의미합니다. DHCP는 이더넷을 통해 장비를 쉽게 연결하도록 돕고 지정된 IP 주소가 서로 충돌하지 않도록 합니다. 대부분의 컴퓨터와 네트워크 스위치에서는 DHCP를 지원합니다.

고정 IP(Static IP) - 직접 IP 주소를 설정하는 경우 'Static IP'로 프로토콜 설정하면 수동으로 IP 설정이 변경됩니다.

고정 IP 주소는 Web Presenter를 재부팅해도 변경되지 않습니다.

회사 네트워크에 Web Presenter를 연결할 경우, 고정 IP 주소의 사용은 필수입니다. 네트워크 관리자가 있는 경우, 네트워크에 연결된 모든 장비를 위한 커스텀 IP 주소가 있을 수도 있습니다. 회사에서 자신의 컴퓨터 및 네트워크를 관리하고 있는 지를 담당 네트워크 관리자와 확인하는 것이 좋습니다.

다이렉트 스트리밍을 위한 인터넷 공유 설정

Web Presenter를 네트워크 스위치 또는 인터넷 라우터에 직접 연결할 수 없는 경우, 사용하는 컴퓨터의 인터넷 연결을 Web Presenter의 이더넷 포트와 공유할 수 있습니다.

다이렉트 스트리밍을 위한 Blackmagic Web Presenter 설정하기

- 1 Web Presenter에서 DHCP를 사용하도록 설정하세요.
- 2 이더넷 포트를 통해 컴퓨터의 인터넷 연결을 공유하도록 설정하세요.

Mac 사용자: '시스템 환경설정'에서 '공유'를 클릭한 다음, 서비스 목록에서 '인터넷 공유'를 선택하세요. 사용하는 Mac이 와이파이로 인터넷이 연결된 경우 '연결 공유' 메뉴에서 'Wi-Fi'를 선택하세요. '다음 사용' 목록에서는 '이더넷'을 선택하세요. '서비스' 목록에서 '인터넷 공유' 확인란을 선택하세요. '인터넷 공유를 켜시겠습니까?' 라고 묻는 화면이 나타나면 '시작' 버튼을 클릭하세요.

Windows 사용자: 시작 아이콘을 우클릭 한 후 '네트워크 연결'을 선택하세요. '네트워크 상태' 스크린이 나타나면 '어댑터 옵션 변경'을 클릭하면 연결된 네트워크 목록이 나타납니다. 사용자의 네트워크에서 우클릭한 후 '속성'을 클릭하세요. '공유' 탭으로 들어가서 '다른 네트워크 사용자가 이 컴퓨터의 인터넷 연결을 통해 연결할 수 있도록 허용'을 선택하세요. 메뉴에서 네트워크 연결을 선택한 다음, '확인'을 클릭하세요.

- 3 Web Presenter를 컴퓨터 이더넷 포트에 연결하세요. 몇 초 후에 DHCP에서 Web Presenter에 IP 주소를 지정하세요.
- 4 LCD 화면 우측 상단에 있는 이더넷 아이콘을 보고 Web Presenter가 이더넷을 통해 인터넷에 연결되었는지를 확인하세요.

스마트폰을 사용하여 스트리밍 하기

스마트폰 테더링을 통해 Blackmagic Web Presenter에서 스트리밍할 수 있습니다. 다시 말해, 스마트폰의 셀룰러 연결만 있으면 전세계 어디서든 스트리밍이 가능합니다.

모바일 테더링 설정하기

- 1 USB-C 케이블로 스마트폰을 Blackmagic Web Presenter에 연결하세요. 제품 전면 또는 뒷면 패널에 있는 USB-C 커넥터를 사용하세요.
- 2 스마트폰의 인터넷 핫스팟 기능을 활성화 하세요.

사용하는 iOS 장치에서 '설정' > '개인용 핫스팟'으로 이동하여 '다른 사람의 연결 허용' 옵션을 켜세요. 안드로이드 장치를 사용하는 경우, 화면을 쓸어넘겨 킷 메뉴에 접속합니다. 핫스팟 아이콘을 길게 누른 다음, USB 테더링 기능을 켜세요.

Blackmagic Web Presenter에서 ON AIR 버튼을 누르면 방송이 시작됩니다.

정보 스트리밍이 끝나면 테더링 연결을 다시 꺼서 스마트폰의 배터리 수명을 절약하는 것이 좋습니다.

Web Presenter에 이더넷 케이블이 연결된 경우, 휴대폰의 이더넷 테더링을 사용하도록 설정되어 있는지 확인하세요. Web Presenter Setup 유틸리티를 열고 'Setup' 탭으로 이동합니다. 'Network'에서 'Connection priority'를 'Mobile'로 설정하세요.

Blackmagic Web Presenter HD의 웹캠 출력 사용하기

Skype 또는 Zoom 같은 소프트웨어는 자동으로 Web Presenter를 웹캠으로 설정하기 때문에 프로그램을 시작하면 바로 Web Presenter 영상이 나타납니다. 프로그램에서 Web Presenter를 자동으로 선택하지 않을 경우, Web Presenter를 웹캠과 마이크로 사용하도록 수동 설정하세요.

아래 예는 Skype에서 웹캠을 설정하는 방법을 설명합니다.

- 1 Skype 메뉴바에서 '오디오 및 비디오 설정' 화면으로 들어가세요.
- 2 '카메라' 메뉴를 클릭한 다음, 목록에서 사용하는 Web Presenter를 선택하세요. 미리보기 창에 Web Presenter 영상이 나타나는 것을 볼 수 있습니다.
- 3 '마이크' 메뉴로 이동하여 오디오 소스를 Web Presenter로 선택하세요.

Open Broadcaster 설정하기

Open Broadcaster는 Web Presenter와 유튜브, 트위치, 페이스북 라이브 같은 인기 스트리밍 소프트웨어 사이의 매개체로 활용할 수 있는 개방형 스트리밍 플랫폼입니다. Open Broadcaster는 스트리밍 소프트웨어가 쉽게 처리할 수 있는 비트레이트로 영상을 압축합니다.

다음은 Web Presenter에서 유튜브 라이브로 웹캠 출력을 스트리밍할 수 있도록 Open Broadcaster를 설정하는 방법에 대해 소개합니다.

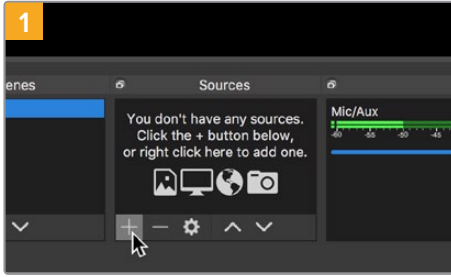

1 Open Broadcaster를 실행한 다음, 'Source' 박스에서 '+' 를 클릭하세요.

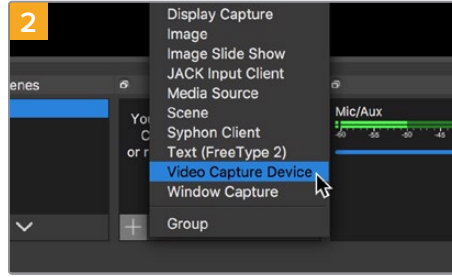

2 'Video Capture Device'를 선택하세요.

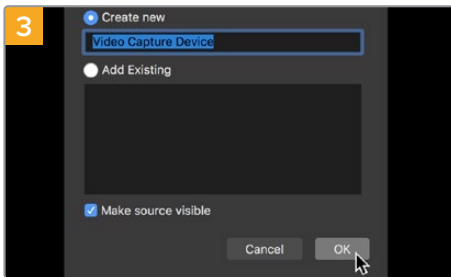

3 소스명을 새로 지정한 다음, 'OK' 버튼을 클릭하세요.

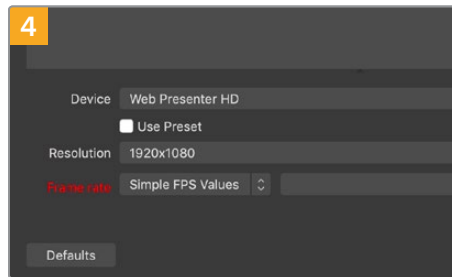

4 'Device' 메뉴에서 Web Presenter 모델명을 클릭한 다음 'OK'를 클릭하세요.

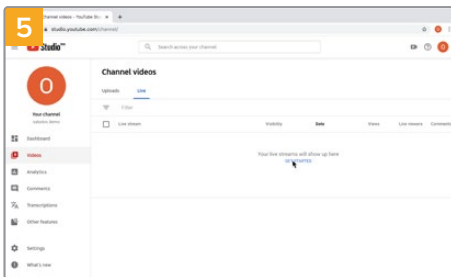

5 자신의 유튜브 계정으로 들어갑니다. 'Go Live' 버튼을 클릭한 다음, 'Stream'을 클릭하세요..

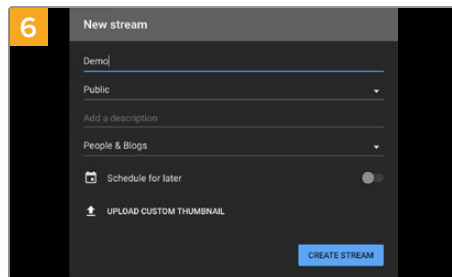

6 유튜브의 '스트림' 옵션에서 자신의 방송 정보를 입력한 후, '스트림 만들기'를 클릭하세요.

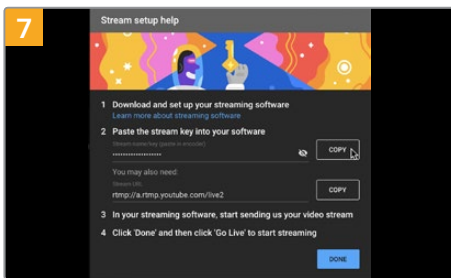

7 이제 유튜브에서 Open Broadcaster를 자신의 유튜브 계정으로 전송하는 스트림 키가 생성됩니다. 스트림 키 옆의 '복사' 버튼을 클릭하세요. Open Broadcaster에 붙여넣기 할 스트림 키를 복사하세요.

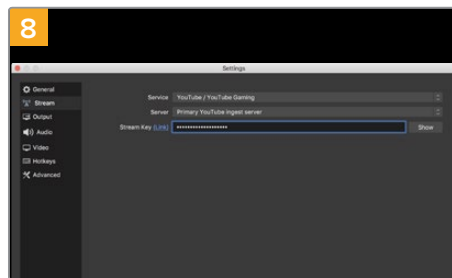

8 Open Broadcaster로 다시 돌아와서 메뉴바에서 'OBS' > 'Preferences'를 클릭하세요. 'Stream'을 선택하세요. 유튜브에서 복사했던 스트림 키를 붙여넣은 후, 'OK'를 클릭하세요.

이제 Web Presenter에서 출력되는 영상을 Open Broadcaster의 미리보기 창에서 확인할 수 있습니다.

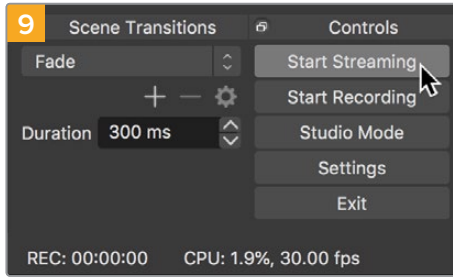

화면 우측 하단에서 'Start Streaming'을 클릭하여 Open Broadcaster의 방송 링크를 유튜브에 연결하세요.

Open Broadcaster에서 유튜브로 연결이 생성되며, 연결과 함께 유튜브 라이브에서 모든 사항을 설정할 수 있습니다.

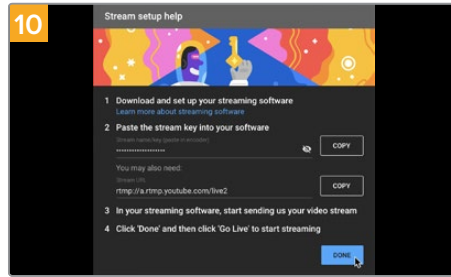

유튜브 라이브로 돌아가면 Web Presenter의 웹캠 프로그램 출력이 배경 영상으로 나타나는 것을 확인할 수 있습니다. '완료'를 클릭하세요.

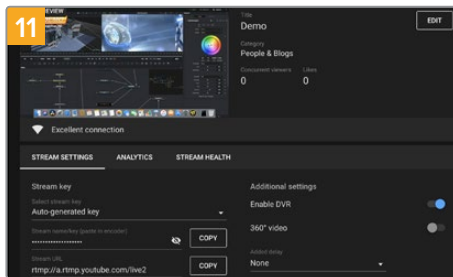

Open Broadcaster가 유튜브 라이브와 완벽히 연결되었으므로, 이제 방송 준비가 완료되었습니다. 방송 전에 모든 준비가 완료되었는지 최종 점검하세요.

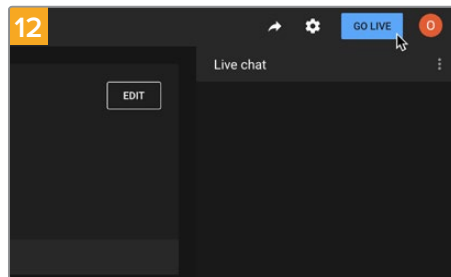

점검이 끝나면 '시작'을 클릭하여 방송을 시작하세요.

이제 Open Broadcaster에서 유튜브로 방송이 실시간 스트리밍됩니다.

참고 인터넷 스트리밍의 특성상 자주 지연될 수 있으므로 방송이 채 끝나기 전에 실수로 종료 버튼을 누르지 않도록 주의해야 합니다. 따라서 유튜브에서 스트리밍 영상을 지켜보며 방송이 종료된 것을 반드시 확인한 후에 '스트림 종료'를 클릭하세요.

ATEM Streaming Bridge로 비디오 링크 생성하기

ATEM Streaming Bridge는 Web Presenter에서 스트리밍되는 모든 영상을 디코딩하여 SDI 또는 HDMI 영상으로 변환합니다. 인터넷을 통해 로컬 네트워크나, 전 세계 어디든 비디오를 전송할 수 있습니다.

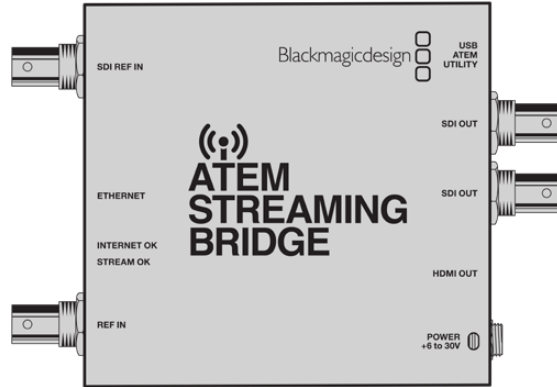

ATEM Streaming Bridge를 Web Presenter가 연결된 로컬 네트워크에 연결하면 Web Presenter Setup의 라이브 스트림 탭에 있는 'Platform' 메뉴에 컨버터가 나타납니다.

다른 방법으로는 Web Presenter에 연결된 USB 드라이브나, Web Presenter Setup을 사용하는 컴퓨터를 통해 스트리밍 설정 XML 파일을 불러올 수 있습니다.

Blackmagic Web Presenter가 ATEM Streaming Bridge를 함께 사용하는 대표적인 예는 기상 예보를 원격으로 스튜디오에 송신하는 것입니다. 원격 장소에서 송신에 필요한 것은 Web Presenter와 휴대폰 또는 네트워크를 통한 인터넷 연결만 있으면 됩니다.

스튜디오에서는 ATEM Streaming Bridge가 인터넷 피드를 받아 이를 SDI로 변환하면 스튜디오에 있는 메인 스위처에 연결할 수 있습니다.

위와 같은 워크플로 셋업을 위한 예시는 다음과 같습니다.

- 1 송신 장소에서 Blackmagic Web Presenter를 ATEM Constellation 8K와 같은 스위처의 프로그램 SDI 출력에 연결하세요.
- 2 Blackmagic Web Presenter를 스마트폰에 연결합니다.
- 3 스튜디오에서는 ATEM Streaming Bridge를 이더넷 연결을 통해 인터넷에 연결합니다.
- 4 ATEM Streaming Bridge에서 변환한 SDI 영상 피드를 메인 뉴스 방송을 위한 스튜디오 스위처의 SDI 입력에 전송합니다.

스튜디오에서 ATEM Streaming Bridge를 Web Presenter의 인터넷 피드에 연결하려면 ATEM Setup 유틸리티를 열고 인터넷 설정을 변경하세요. 모든 스트리밍 설정을 포함한 XML 파일을 생성한 다음, 원격으로 사용하는 Web Presenter에 이를 로딩하는 것 또한 방법입니다.

ATEM Streaming Bridge를 인터넷에 연결하여 스트리밍 XML 파일을 생성하는 방법에 관한 자세한 설명은 ATEM Mini 설명서를 참고하세요.

XML 파일 생성하기

XML 설정 파일을 생성하려면 ATEM Streaming Bridge의 이더넷 포트를 인터넷 라우터 또는 네트워크 스위치에 꽂아 인터넷에 연결하세요.

USB-C 케이블로 ATEM Streaming Bridge를 사용 중인 컴퓨터에 연결하고 ATEM Setup을 실행하세요.

설정 탭에서 네트워크가 올바르게 설정되어 있는지 확인하고, '스트림 서비스' 옵션을 '인터넷'으로 선택하세요. 인터넷 상태창에 'Visible Worldwide'가 나타나는 것을 확인할 수 있습니다. 이는 모든 것이 올바르게 작동되고 있음을 의미합니다.

포트 포워딩에 관한 노트

'인터넷 상태' 창에 포트 포워딩 또는 UPnP 에러가 나타날 경우, 사용하는 인터넷 업체나 네트워크 관리자에게 문의하여 현재 사용 중인 인터넷 연결의 포트 포워딩을 'TCP port 1935'로 설정하세요.

XML 파일 보내기

ATEM Setup 탭에서 ATEM Streaming Bridge가 사용 중인 네트워크 또는 인터넷에 올바르게 연결되어 있는지 설정을 확인한 다음, XML 설정 파일을 보내기 하세요.

- 1 윈도우 우측 상단에 있는 '외부 ATEM Mini Pro' 탭을 선택하세요.

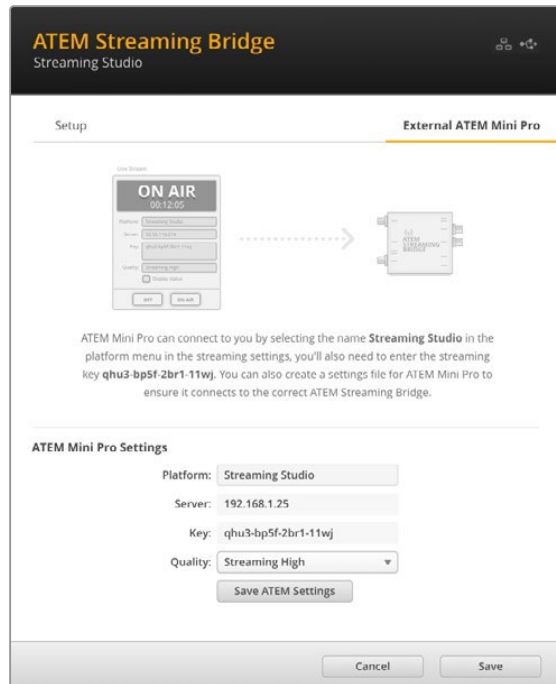

- 2 플랫폼 상자를 클릭하고 새로운 플랫폼 이름을 설정하세요. 원거리에 있는 Blackmagic 기기의 플랫폼 메뉴에 해당 이름 목록이 나타납니다.
- 3 원하는 스트리밍 화질을 선택하세요. 원격 Web Presenter의 화질을 설정하세요.
- 4 'ATEM 설정 저장하기' 버튼을 클릭하고, XML 파일을 저장하려는 위치를 지정한 다음, '저장' 버튼을 클릭하세요.
- 5 저장된 XML 파일을 원격으로 운영자에게 이메일로 전송할 수 있습니다.

TIP 정보 ATEM Setup의 토크백 설정을 사용하여 원격 Web Presenter로 다시 전송하려는 오디오 채널을 선택하세요.

XML 파일 로딩하기

원격지에 파일이 이메일로 전송되도록 설정된 상태에서 원격지에 있는 제작진이 Blackmagic Web Presenter 셋업을 사용하여 해당 XML 파일을 Web Presenter에 로딩한 다음, 'ON AIR' 버튼을 누르면 스튜디오에 기상 예보를 스트리밍할 수 있습니다.

스트리밍 XML 파일을 로딩하고 나면 다시 로딩하지 않고 스트리밍을 시작/정지할 수 있다는 것을 기억하세요. 이를 통해 Web Presenter와 ATEM Streaming Bridge 사이의 비디오 링크를 확실하게 설정할 수 있습니다.

스튜디오에서 사용하는 ATEM Streaming Bridge의 스트리밍 및 네트워크 설정을 변경하지 않고 계속해서 Web Presenter에 연결되어 있는 한 인터넷 위치와 상관없이 항상 Web Presenter를 감지합니다. 어디서든 Web Presenter를 인터넷에 연결하고 'ON AIR' 버튼만 누르면 스튜디오에 있는 ATEM Streaming Bridge에 즉각 스트리밍됩니다.

ATEM Streaming Bridge 사용법에 관한 더욱 자세한 설명은 ATEM Mini 설명서에 나와 있으며, www.blackmagicdesign.com/kr/support에서 다운로드할 수 있습니다.

탈리, 토크백, 카메라 컨트롤

ATEM Streaming Bridge와 Blackmagic Web Presenter를 통해 ATEM 스위처에서 탈리 토크백, 카메라 컨트롤 정보를 전송하도록 할 수 있습니다. SDI 기반의 모든 Blackmagic Design 카메라는 로컬 네트워크상에 있는 모든 곳 또는, 인터넷을 통해 전 세계 어디서든 사용할 수 있으며, 탈리와 토크백, 카메라 컨트롤 기능 또한 사용할 수 있습니다.

셋업은 매우 간단합니다. 아래 그림은 로컬 네트워크를 통해 URSA Mini Pro 4.6K를 ATEM Constellation 8K에 연결하여 탈리 및 토크백, 카메라 컨트롤 기능이 작동하는 방식을 보여줍니다.

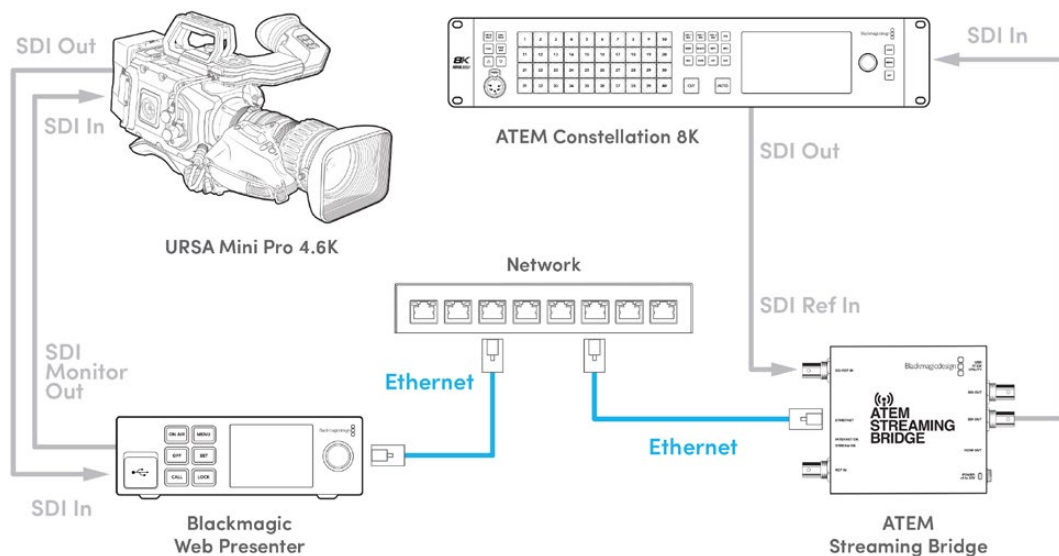

모든 연결이 완료되면 다음과 같이 설정하세요.

- 1 Blackmagic Web Presenter의 ‘메뉴’ 버튼을 눌러 LCD 메뉴를 열고 라이브 스트리밍 메뉴로 이동하세요.
- 2 ‘플랫폼’ 설정에서 ATEM Streaming Bridge를 선택하세요.
- 3 ‘SET’ 버튼을 눌러 선택을 완료하세요.

탈리가 작동하기 위해서는 카메라의 ATEM 카메라 ID가 스위치의 입력과 일치해야 합니다. ATEM 카메라 ID 설정 방법에 관한 자세한 정보는 URSA Mini 설명서를 참조하세요.

ATEM 스위치의 프로그램 출력으로 카메라를 전환하여 탈리가 작동 중인지 테스트해 볼 수 있습니다. 카메라에 ATEM 카메라 ID가 제대로 설정되면 탈리 불빛과 함께 카메라 LCD 테두리에 들어오는 빨간색 탈리를 확인할 수 있습니다. 이제 카메라를 미리보기 출력으로 전환하면 탈리에 초록색 불이 켜집니다.

ATEM Software Control의 카메라 페이지에서 조리개와 페디스털을 조절하여 카메라 컨트롤 기능을 테스트해보세요.

임베디드 SDI 오디오 채널 15/16이 기본 토크백 채널로 설정되어 있지만, 엔지니어링 채널 13/14로 토크백 채널을 바꾸거나 ATEM Setup 유틸리티를 사용하여 프로그램 출력으로 바꿀 수 있습니다.

인터넷으로 송신할 경우에는 ATEM Setup 유틸리티를 사용해 XML 셋업 파일을 생성하세요. 생성된 XML 파일을 Blackmagic Web Presenter에 로딩하면 인터넷상에서 ATEM Streaming Bridge를 찾을 수 있습니다. XML 셋업 파일 생성 및 로딩 방법에 관한 자세한 정보는 본 설명서의 앞부분에서 확인할 수 있습니다.

URSA Broadcast G2 연결하기

URSA Broadcast G2에는 스트리밍 엔진이 내장되어 있어 Blackmagic Web Presenter를 사용하지 않아도 카메라에서 USB-C 확장 포트에 직접 스트리밍할 수 있습니다. 탈리 작동 확인을 위한 ATEM 카메라 ID 셋업 방식 등의 더 자세한 정보는 URSA Broadcast G2 설명서를 참고하세요.

Blackmagic Universal Rack Shelf

Blackmagic Universal Rack Shelf를 사용하면 1RU 크기의 선반으로 다양한 종류의 Blackmagic Design 장비를 방송용 장비랙 또는 로드 케이스에 설치할 수 있습니다. 실용성과 휴대성을 제공하는 모듈식 디자인으로 설계되어 1RU 크기 장비를 이동이 가능한 실용적인 셋업으로 설치할 수 있습니다.

밑의 보기는 3대의 Universal Rack Shelf가 소형 랙에 설치되어 있으며, 내부에는 여러 대의 호환 장비가 설치되어 있는 모습입니다. 아래 보기는 3대의 Universal Rack Shelf를 소형 랙에 설치한 모습으로 내부에는 여러 대의 호환 장비가 설치되어 있습니다.

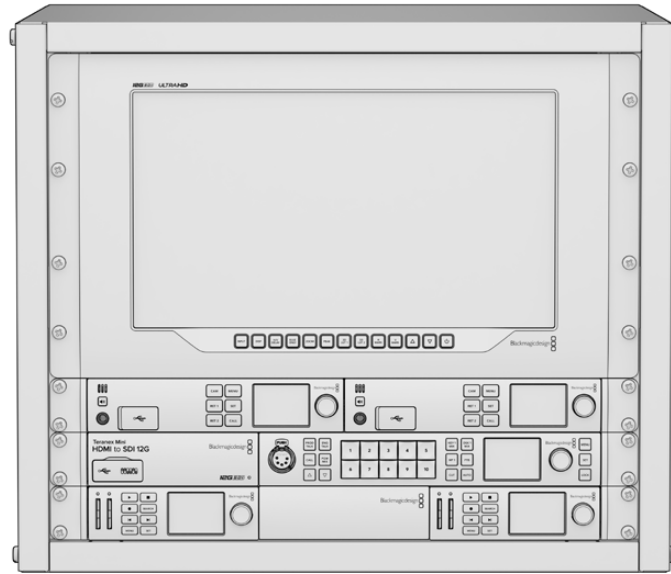

목차

Universal Rack Shelf Kit의 구성 품목은 다음과 같습니다.



1 x Blackmagic Universal Rack Shelf

Blackmagic Design 장비 설치를 위한 전체 너비를 가진 1RU 크기의 선반입니다.

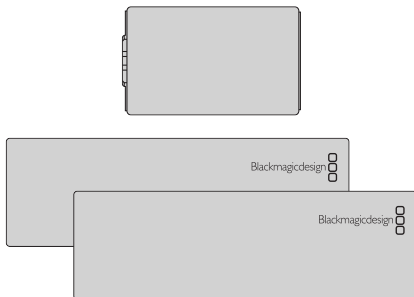

블랭킹 패널

사용하지 않는 선반 공간을 채울 수 있는 1개의 1/6 랙 너비 패널과 2개의 1/3 랙 너비 패널을 제공하는 블랭킹 패널입니다.

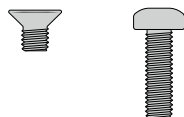

나사

12 x M3 5mm 2 x M3 9mm 접시머리
카운터싱크 마운팅 나사 나사 (1/6 블랭킹 패널용)

랙 선반에 장비 설치하기

- 1 고무발이 부착된 경우 가장자리가 플라스틱인 스크래핑 도구를 사용하여 장비 밑의 발을 제거하세요.
- 2 장비랙과 제품을 모두 뒤집은 다음, 랙에 있는 구멍과 Blackmagic Design 장비 밑면에 있는 나사 구멍이 일치하도록 정렬하세요. 1/3 너비의 장비에는 2개의 중앙 마운팅 포인트가 있고 이보다 더 큰 1/2 랙 너비 장비에는 최대 3개의 마운팅 포인트가 있습니다.

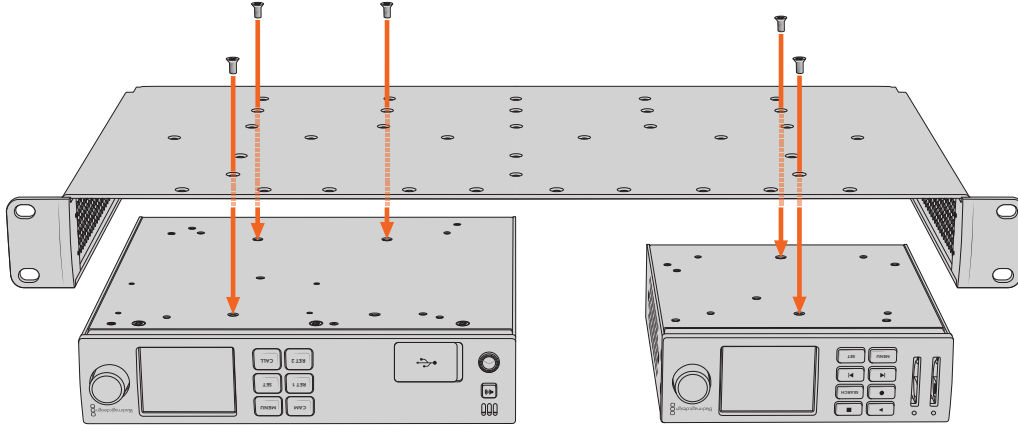

- 3 제품과 함께 제공된 M3 5mm 카운터싱크 나사를 사용해 장비를 랙 선반에 설치하세요.
- 4 나사를 조인 다음, 랙 선반을 다시 돌려 정위치로 놓고, 함께 제공되는 랙 이어를 사용하여 랙 선반을 설치하세요.

제공되는 블랭킹 패널은 사용하지 않는 선반 빈공간을 채우는 용도로 사용할 수 있습니다.

1/6 블랭킹 패널 장착하기

작은 1/6 블랭킹 패널은 1/2 및 1/3 랙 너비의 장비를 설치할 때 사용하지 않는 선반 공간을 채우는 데 사용할 수 있습니다. 이 패널은 장비의 한 면에 부착할 수 있습니다. 원활한 공기 흐름을 위해 장비 사이에 블랭킹 패널을 설치하는 것을 권장합니다.

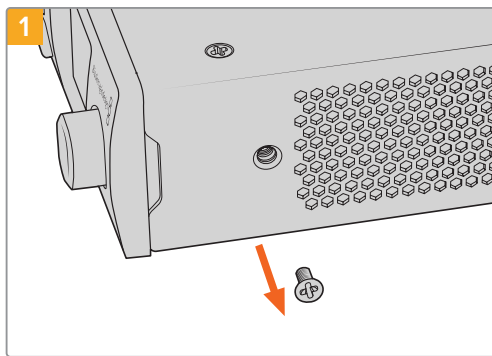

장비 앞쪽에 있는 5mm M3 나사를 제거하세요.

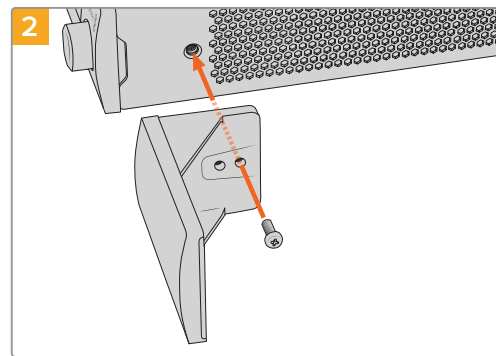

구멍에 맞춰 블랭킹 패널을 정렬한 다음 제품과 함께 제공된 M3 9mm 나일론 나사를 사용해 장착하세요.

측면 1/3RU 블랭킹 패널 장착하기

대형 측면 1/3 블랭킹 패널은 여러 1RU 장비 설치 시, 랙 선반 측면에 바로 부착할 수 있습니다. 블랭킹 패널을 설치하려면 패널 바닥에 있는 나사 구멍과 고정점을 선반에 맞춰 함께 제공되는 M3 5mm 카운터싱크 나사 2개를 사용해 고정하세요.

내부 소프트웨어 업데이트

셋업 유틸리티는 Web Presenter의 내부 소프트웨어를 업데이트하고, 스트리밍 설정 및 네트워크 설정, 스트리밍 품질을 변경할 수 있습니다.

내부 소프트웨어 업데이트하기

- 1 www.blackmagicdesign.com/kr/support에서 최신 Blackmagic Web Presenter 설치 프로그램을 다운로드하세요.
- 2 Web Presenter 설치 프로그램을 실행하여 화면에 나타나는 지시 사항을 따르세요.
- 3 설치가 완료되면, 제품 전면 또는 뒷면 패널의 플라스틱 덮개 안에 있는 USB 커넥터를 통해 Web Presenter를 컴퓨터에 연결하세요.
- 4 Blackmagic Web Presenter Setup을 실행한 뒤, 화면에 나타나는 지시 사항에 따라 내부 소프트웨어 업데이트를 진행하세요. 내부 소프트웨어가 최신 버전일 경우 아무런 메시지가 나타나지 않으며 더 이상의 추가 작업이 필요하지 않습니다.

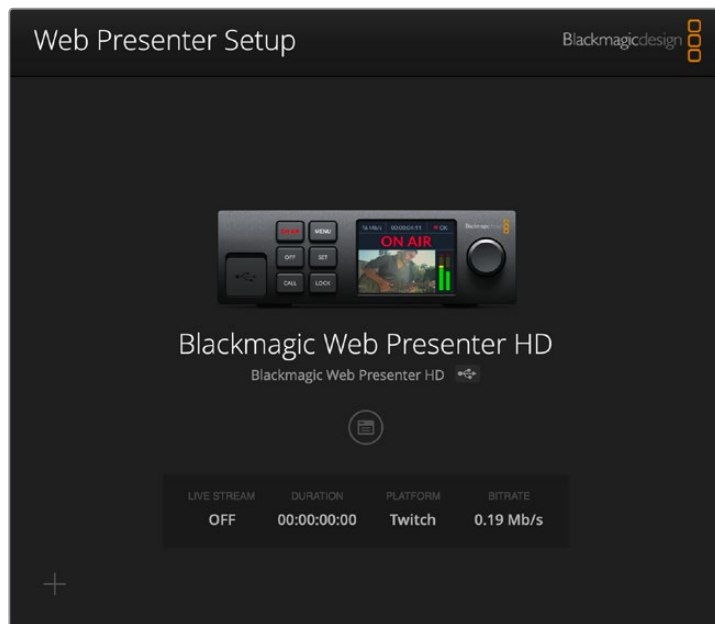

Blackmagic Design 고객 지원 센터(www.blackmagicdesign.com/kr/support)에서 Blackmagic Web Presenter를 위한 최신 Setup 유틸리티를 다운로드하세요.

Developer Information

Blackmagic Web Presenter Ethernet Protocol

v1.2

Protocol Details

Overview

The Blackmagic Web Presenter Ethernet Protocol is a line-oriented, text-based protocol to control a Web Presenter.

Lines from the Web Presenter server will be separated by an ASCII LF sequence.

Messages from the user may be separated by LF or CR LF.

Connection

The Web Presenter server is accessed by connecting to TCP port 9977 on a Web Presenter.

Connection Response

Upon connection, the Web Presenter server sends a dump of the device's state.

The Web Presenter server sends information in blocks, with each having an identifying header followed by a colon. A block spans multiple lines and is terminated by a blank line. Each line in the protocol is terminated by a newline character.

Following the header, a block contains either a single multi-line string or a sequence of key/value pairs arranged one per line. The first full-colon on a line is used to delimit the key and the value. A value may be a comma separated list. In this case, values in the list must have the “,” and “\” characters escaped with a “\” character.

To be resilient to future protocol changes, clients should ignore blocks they do not recognize, up to the trailing blank line. Within recognized blocks, clients should ignore keys they do not recognize.

Legend

↵	End of line
...	and so on
Orange Text	Client Generated
Grey Text	Server Generated

The protocol preamble block is always the first block sent by the Web Presenter server:

```
PROTOCOL PREAMBLE:↵
```

```
Version: 1.2↵
```

```
↵
```

The version field indicates the protocol version. When the protocol is changed in a compatible way, the minor version number will be updated. If incompatible changes are made, the major version number will be updated.

The initial status dump is concluded by the end prelude block:

```
END PRELUDE:↵
```

↵

Status Updates

When any device parameter is changed on the Web Presenter server by any client, such as the Blackmagic Web Presenter Setup utility, the Web Presenter server resends the applicable status block, containing only the items that have changed. Status updates can also occur due to external changes such as tethering to a smartphone or when a streaming service is disconnected.

For example, if the input video mode is set to Auto, the following block will be sent:

```
STREAM SETTINGS:↵  
Video Mode: Auto↵  
↵
```

Requesting Changes

To change one or more parameters in a block, the client should send the appropriate block header in the same form the Web Presenter server sends, followed by the key/value pairs to be changed. For example, to change the input video format to 1080p59.94, the user should send the following block:

```
STREAM SETTINGS:↵  
Video Mode: 1080p59.94↵  
↵
```

The block must be terminated by a blank line. On receipt of a blank line, the Web Presenter server will either acknowledge the request by responding:

```
ACK↵  
↵
```

or if unable to parse the block responding with:

```
NACK↵  
↵
```

After a positive response, the client should expect to see a status update from the Web Presenter server showing the status change. This is likely to be the same as the command that was sent, sometimes followed by other blocks providing data specific to the change.

```
STREAM SETTINGS:↵  
Video Mode: 1080p59.94↵  
↵
```

If the Web Presenter server does not understand a key in the requested block, the key will be ignored. If an invalid value is provided for a known key, then the request is ignored and the Web Presenter will respond with the existing value for the key. In both cases the Web Presenter server will still respond with an ACK.

```
STREAM SETTINGS:↵  
Video Mode: UnsupportedMode↵  
↵  
ACK↵  
↵  
STREAM SETTINGS:↵
```

```
Video Mode: 1080p59.94↵
```

```
↵
```

Requesting a Status Dump

The user may request that the Web Presenter server resend the complete state of any status block by sending the block header, followed by a blank line. In the following example, the user requests the Web Presenter server resend the stream settings:

```
STREAM SETTINGS:↵
```

```
↵
```

```
ACK↵
```

```
↵
```

```
STREAM SETTINGS:↵
```

```
Video Mode: 1080p59.94↵
```

```
...
```

```
↵
```

Protocol Blocks

Identity Block

The identity block contains information to identify the connected Web Presenter.

Block Syntax

The following example shows the Identity Block for a Blackmagic Web Presenter HD.

```
IDENTITY:↵
```

```
Model: Blackmagic Web Presenter HD↵
```

```
Label: Blackmagic Web Presenter HD↵
```

```
Unique ID: 00112233445566778899AABBCCDDEEFF↵
```

```
↵
```

Parameters

Key	Read/Write	Description	Valid Values
Model	Read only	The Web Presenter model name	String
Label	Read/Write	A display name for the Web Presenter	String
Unique ID	Read only	A device specific unique identifier	Hexadecimal ID

Changing Device Label

A device label to identify the Web Presenter can be changed by sending an identity block with label key.

```
IDENTITY:↵
```

```
Label: My Web Presenter↵
```

```
↵
```

```
ACK↵
```

```
↵
```

```
IDENTITY:↵
```

```
Label: My Web Presenter↵
```

```
↵
```

Version Block

The version block contains hardware and software version information for the connected Web Presenter.

Block Syntax

```
VERSION:↵  
Product ID: BE73↵  
Hardware Version: 0100↵  
Software Version: 0123ABCD↵  
Software Release: 3.3↵  
↵
```

Parameters

Key	Read/Write	Description	Valid Values
Product ID	Read only	The Web Presenter product ID	Hexadecimal ID
Hardware Version	Read only	The Web Presenter hardware version	Hexadecimal version
Software Version	Read only	The Web Presenter software version	Hexadecimal version
Software Release	Read only	The Web Presenter software release version	Version Number

Network Blocks

The network block contains the TCP/IP networking configuration for the connected Web Presenter.

Block Syntax

This example shows the output for a connected Web Presenter. It displays 2 networking interfaces - the Gigabit Ethernet interface and option for a tethered smartphone.

The network settings prefixed with Current show the active TCP/IP settings, and are read-only. The Current settings reflect either the DHCP or Static configuration, depending on the Dynamic IP flag.

```
NETWORK:↵  
Interface Count: 2↵  
Default Interface: 0↵  
↵  
NETWORK INTERFACE 0:↵  
Name: Ethernet↵  
Priority: 1↵  
MAC Address: 00:11:22:33:44:55↵  
Dynamic IP: true↵  
Current Addresses: 192.168.1.10/255.255.255.0↵  
Current Gateway: 192.168.1.1↵  
Current DNS Servers: 192.168.1.1, 8.8.8.8, 8.8.4.4↵  
Static Addresses: 10.0.0.2/255.255.255.0↵  
Static Gateway: 10.0.0.1↵  
Static DNS Servers: 8.8.8.8, 8.8.4.4↵  
↵
```



```

NETWORK INTERFACE 1:↵
Name: USBEthernet↵
Priority: 0↵
MAC Address: 00:00:00:00:00:00↵
Dynamic IP: true↵
Current Addresses: 0.0.0.0/255.255.0.0↵
Current Gateway: 0.0.0.0↵
Current DNS Servers: ↵
Static Addresses: 10.0.0.2/255.255.255.0↵
Static Gateway: 10.0.0.1↵
Static DNS Servers: 8.8.8.8, 8.8.4.4↵
↵

```

Parameters

Network Block

Key	Read/Write	Description	Valid Values
Interface Count	Read only	The number of networking interfaces supported by the Web Presenter	Integer
Default Interface	Read only	The default networking interface	Integer

Network Interface Block

Key	Read/Write	Description	Valid Values
Name	Read only	The name of the networking interface	String
Priority	Read/Write	The priority of the network interface. When multiple network interfaces are available, the high priority interface will become the default	Unsigned integer. The higher number is the higher priority
MAC Address	Read Only	MAC address of the networking interface	IEEE 802 MAC address
Dynamic IP	Read/Write	Selects DHCP or Static IP configuration	true - DHCP enabled false - Static IP
Current Addresses	Read Only	The current IP address and Subnet mask	{IPv4 address}/{Subnet Mask}
Current Gateway	Read Only	The current IP gateway address	IPv4 address
Current DNS Servers	Read only	The IP addresses of the current DNS servers	Comma separated list of IPv4 addresses
Static Addresses	Read/Write	Status IP address and subnet mask when DHCP disabled	{IPv4 address}/{Subnet Mask}
Static Gateway	Read/Write	Static gateway address when DHCP disabled	IPv4 address
Static DNS Servers	Read/Write	The IP addresses of the static DNS servers	Comma separated list of IPv4 addresses

Changing Networking Settings

The network can be configured to use either DHCP or a static configuration. To enable DHCP on Network Interface 0:

```
NETWORK INTERFACE 0:↵  
Dynamic IP: true↵  
↵  
ACK↵  
↵  
NETWORK INTERFACE 0:↵  
Dynamic IP: true↵  
↵
```

To set a fixed IP address, supply all static parameters:

```
NETWORK INTERFACE 0:↵  
Dynamic IP: false↵  
Static Addresses: 192.168.1.2/255.255.255.0↵  
Static Gateway: 192.168.1.1↵  
Static DNS Servers: 8.8.8.8, 8.8.4.4↵  
↵  
ACK↵  
↵  
NETWORK INTERFACE 0:↵  
Dynamic IP: false↵  
Static Addresses: 192.168.1.2/255.255.255.0↵  
Static Gateway: 192.168.1.1↵  
Static DNS Servers: 8.8.8.8, 8.8.4.4↵  
↵
```

Changing network settings may cause the IP connection to be dropped.

UI Settings Block

The UI settings block contains the front panel LCD and monitor output settings for the connected Web Presenter.

Block Syntax

```
UI SETTINGS:↵  
Available Locales: en_US.UTF-8, zh_CN.UTF-8, ja_JP.UTF-8, ko_KR.UTF-8, es_↵  
ES.UTF-8, de_DE.UTF-8, fr_FR.UTF-8, ru_RU.UTF-8, it_IT.UTF-8, pt_BR.UTF-8,↵  
tr_TR.UTF-8, pl_PL.UTF-8, uk_UA.UTF-8↵  
Current Locale: en_US.UTF-8↵  
Available Audio Meters: PPM -18dB, PPM -20dB, VU -18dB, VU -20dB↵  
Current Audio Meter: PPM -20dB↵  
↵
```

Parameters

Key	Read/Write	Description	Valid Values
Available Locales	Read only	The locales available in the Web Presenter	Comma separated list of locales
Current Locale	Read/Write	The current locale for Web Presenter	Refer to the locales from the Available Locales field
Available Audio Meters	Read only	The available audio meters supported by the Web Presenter	Comma separated list of audio meter types
Current Audio Meter	Read/Write	The current audio meter	Refer to the audio meters from the Available Audio Meters field

Stream Settings Block

The stream settings block contains the stream configuration for the connected Web Presenter.

Block syntax

This example shows the output for a connected Web Presenter. The stream settings prefixed with Current show the active stream settings and are writable. The stream settings prefixed by Available show the available stream settings for the device or platform and are read-only. To view the available servers or quality levels for a stream service, the Current Platform stream setting should be set first.

```
STREAM SETTINGS:↵
Available Video Modes: Auto, 1080p23.98, 1080p24, 1080p25, 1080p29.97,
1080p30, 1080p50, 1080p59.94, 1080p60, 720p25, 720p30, 720p50, 720p60↵
Video Mode: 1080p59.94↵
Current Platform: YouTube↵
Current Server: Primary↵
Current Quality Level: Streaming Medium↵
Stream Key: abc1-def2-ghi3-jkl4-mno5↵
Password: ↵
Current URL: srt://192.168.8.51
Customizable URL: true
Available Default Platforms: YouTube RTMP, YouTube SRT (Beta), Facebook,
Twitch, Twitter, Restream.IO, Vimeo, BoxCast, CastR, AfreecaTV, Bilibili,
DouYu, Weibo↵
Available Custom Platforms: My Platform↵
Available Servers: Primary, Secondary↵
Available Quality Levels: HyperDeck High, HyperDeck Medium, HyperDeck Low,
Streaming High, Streaming Medium, Streaming Low↵
↵
```

Parameters

Key	Read/Write	Description	Valid Values
Available Video Modes	Read only	The video modes available in the Web Presenter	Comma separated list of video modes
Video Mode	Read/Write	The current video mode	Refer to the video modes from the <i>Available Video Modes</i> field
Current Platform	Read/Write	The selected streaming platform	Refer to the platforms from the <i>Available Default Platforms</i> and <i>Available Custom Platforms</i> fields
Current Server	Read/Write	The current server for the streaming platform	Server is dependent on selected Current Platform
Current Quality Level	Read/Write	The current streaming quality level	Quality level is dependent on selected Current Platform
Stream Key	Read/Write	The stream key for the streaming platform	String
Password	Read/Write	The passphrase for an encrypted SRT stream	String
Current URL	Read/Write	The current URL for the streaming platform. This field is writable if <i>Customizable URL</i> field is true.	String
Customizable URL	Read only	A boolean specifying whether custom URLs are supported by the streaming platform	true - Custom URLs are supported false - Custom URLs are not supported
Available Default Platforms	Read only	The available default streaming platforms	Comma separated list of default platforms
Available Custom Platforms	Read only	The custom streaming platforms loaded in the Web Presenter	Comma separated list of custom platforms
Available Servers	Read only	The available servers for the selected streaming platform	Comma separated list of servers
Available Quality Levels	Read only	The available quality levels for the selected streaming platform	Comma separated list of quality levels

Changing Stream Settings

The stream settings can be changed by providing a stream settings block. The following is an example of streaming a 1080p59.94 input on Twitch with a medium stream quality.

```

STREAM SETTINGS:↵
Video Mode: 1080p59.94↵
Current Platform: Twitch↵
Current Server: US West: Los Angeles, CA↵
Current Quality Level: Streaming Medium↵
Stream Key: live_123456789_1aB2cD3eF4gH5iJ6kL7mN8oP9qR0sT↵
↵
ACK↵
↵
STREAM SETTINGS:↵
Video Mode: 1080p59.94↵
Current Platform: Twitch↵
Current Server: US West: Los Angeles, CA↵
Current Quality Level: Streaming Medium↵
Stream Key: live_123456789_1aB2cD3eF4gH5iJ6kL7mN8oP9qR0sT↵
↵

```

Stream XML Block

The stream XML block allows users to configure the Web Presenter with a custom configuration file in XML format.

Block syntax

The following example shows an XML file - Custom.xml has been loaded to configure the stream settings in the Web Presenter.

```
STREAM XML:↵  
Files: Custom.xml↵  
↵
```

Parameters

Key	Read/Write	Description	Valid Values
Files	Read/Write	The XML files loaded in Web Presenter	Comma separated list of filenames
Action	Write only	The stream XML action	Remove Remove All"

Adding a Stream XML file

An XML file can be loaded onto a Web Presenter by sending the stream xml command with a filename, then provide the contents of the XML file. After adding the XML file, the Available Custom Platforms field in the STREAM SETTINGS block will be updated with the new platforms, however the Current items will remain unchanged.

For the Stream XML block to be parsed correctly, any blank lines should be removed from the XML files.

Refer to the `Blackmagic Stream XML File Format` section in this manual for description of the Stream XML file format.

```
STREAM XML Custom.xml:↵  
<?xml version="1.0" encoding="UTF-8"?>↵  
<streaming>↵  
    <service>↵  
        <name>My Custom Platform</name>↵  
        ...  
    </service>↵  
</streaming>↵  
↵  
ACK↵  
↵  
STREAM XML Custom.xml:↵  
<?xml version="1.0" encoding="UTF-8"?>↵  
<streaming>↵  
    <service>↵  
        <name>My Custom Platform</name>↵  
        ...  
    </service>↵  
</streaming>↵  
↵  
STREAM XML:↵  
Files: Custom.xml↵
```

```
↵  
STREAM SETTINGS:↵  
Available Custom Platforms: My Custom Platform↵  
↵
```

Removing a Stream XML file

An XML file can be removed from the Web Presenter by sending the stream xml command with the remove action.

```
STREAM XML:↵  
Action: Remove↵  
Files: Custom.xml↵  
↵  
ACK↵  
↵  
STREAM XML:↵  
Files:↵  
↵  
STREAM SETTINGS:↵  
Available Custom Platforms:↵  
↵
```

Removing all Stream XML files

All XML files can be removed from the Web Presenter by sending the stream xml command with the remove all action. In the example, following the remove all action, the loaded stream XML files and available custom platforms are both displayed as empty.

```
STREAM XML:↵  
Action: Remove All↵  
↵  
ACK↵  
↵  
STREAM XML:↵  
Files: ↵  
↵  
STREAM SETTINGS:↵  
Available Custom Platforms:↵  
↵
```

Stream State Block

The stream state block provides the streaming status of the Web Presenter.

The Web Presenter server will send a stream state block update whenever there is a change to the Status field. Due to frequency of changes to Duration, Bitrate and Cache Used fields, these fields need to be polled by the client by requesting a Stream State block.

Block syntax

```
STREAM STATE:↵↵
Status: Idle↵↵
Bitrate: 161672↵↵
Duration: 00:00:00:00↵↵
Cache Used: 0↵↵
↵↵
```

Parameters

Key	Read/Write	Description	Valid Values
Status	Read only	The stream state of the Web Presenter, updated when the stream status changes	Idle Connecting Streaming Interrupted
Action	Write only	The Web Presenter stream state action.	Start Stop
Duration	Read only	The duration of the active stream	String in format of DD:HH:MM:SS
Bitrate	Read only	The bitrate of the active stream	Integer bits per second
Cache Used	Read only	The current usage of the streaming cache	Integer as a percentage

Starting Stream

The stream is started by providing a stream state block with start action.

```
STREAM STATE:↵↵
Action: Start↵↵
↵↵
ACK↵↵
↵↵
STREAM STATE:↵↵
Status: Connecting↵↵
↵↵
STREAM STATE:↵↵
Status: Streaming↵↵
↵↵
```

Stopping stream

The stream is stopped by providing a Stream State block with stop action.

```
STREAM STATE:↵↵
Action: Stop↵
↵
ACK↵
↵
STREAM STATE:↵↵
Status: Idle↵
↵
```

Audio Settings Block

The Audio Settings block contains the audio configuration for the connected Web Presenter.

Block syntax

This example shows the output for a connected Web Presenter. The stream settings prefixed with Current show the active audio settings and are writable. The stream settings prefixed by Available show the available audio settings for the device or platform and are read-only.

```
AUDIO SETTINGS:↵↵
Current Monitor Out Audio Source: Auto↵
Available Monitor Out Audio Sources: Auto, SDI In, Remote Source↵
↵
```

Parameters

Key	Read/Write	Description	Valid Values
Current Monitor Out Audio Source	Read/Write	The current audio source on the monitor output	Refer to the audio sources from the <i>Available Monitor Out Audio Sources</i> field
Available Monitor Out Audio Sources	Read only	The available audio sources that can be routed to the monitor output	Comma separated list of audio sources

Changing Audio Settings

The audio settings can be changed by providing an audio settings block. The following is an example of setting the monitor output audio source to remote.

```
AUDIO SETTINGS:↵↵
Current Monitor Out Audio Source: Remote Source↵
↵
ACK↵
↵
AUDIO SETTINGS:↵↵
Current Monitor Out Audio Source: Remote Source↵
↵
```

Shutdown Block

The Shutdown block provides power control of the Web Presenter. The Shutdown block is write-only and not presented in the preamble.

Parameters

Key	Read/Write	Description	Valid Values
Action	Write only	The Web Presenter shutdown action.	Reboot Factory Reset

Reboot

The Web Presenter can be rebooted by providing a Shutdown block with reboot action.

```
SHUTDOWN:↵
```

```
Action: Reboot↵
```

```
↵
```

```
ACK↵
```

```
↵
```

On reboot action, the Web Presenter server will be stopped and clients will be disconnected.

Factory Reset

The Web Presenter can be factory reset by providing a Shutdown block with factory reset action. On factory reset action, all settings are set to factory defaults.

```
SHUTDOWN:↵
```

```
Action: Factory Reset↵
```

```
↵
```

```
ACK↵
```

```
↵
```

Blackmagic Streaming XML Format

Overview

The Blackmagic Streaming XML allows users to specify streaming services in addition to the default services provided by the Web Presenter.

The Streaming XML can be loaded into the Web Presenter with Web Presenter Setup. Refer to the 'Using Web Presenter Setup' section earlier in this manual

The Streaming XML can also be loaded by copying the contents into the Stream XML block with the Blackmagic Web Presenter Ethernet Protocol.

The following is a minimal example of a Streaming XML file:

```
<?xml version="1.0" encoding="UTF-8"?>
<streaming>
  <service>
    <name>My Streaming Service</name>
    <servers>
      <server>
        <name>My Streaming Server</name>
        <url>rtmp://my.streaming-server.com/live</url>
      </server>
    </servers>
    <profiles>
      <profile>
        <name>My Streaming Quality</name>
        <config resolution="1080p" fps="60" codec="H264">
          <bitrate>7500000</bitrate>
        </config>
      </profile>
    </profiles>
  </service>
</streaming>
```

Streaming XML Definition

The Streaming XML file follows standard XML format and shall begin with XML declaration.

```
<?xml version="1.0" encoding="UTF-8"?>
```

Streaming Element

The Streaming XML file shall be contained by the <streaming> element. The <streaming> element will consist of 1 or more <service> child elements.

The following is an example of a <streaming> element block that defines 2 streaming services.

```
<streaming>
  <service>
    <name>Service 1</name>
    <!-- Streaming settings for "Service 1" -->
  </service>
  <service>
    <name>Service 2</name>
    <!-- Streaming settings for "Service 2" -->
  </service>
</streaming>
```

Service Element

The <service> element provides a description of the streaming service. If multiple streaming services are used, it is possible to define multiple <service> elements within each <streaming> element block.

The following is an example of a <service> element block in the Stream XML file.

```
<streaming>
  <service customizable-url="true">
    <name>My Streaming Service</name>
    <key>abc1-def2-ghi3-jkl4-mno5</key>
    <servers>
      <!-- Streaming server settings -->
    </servers>
    <profiles default="Streaming High">
      <!-- Streaming quality settings-->
    </profiles>
    <credentials>
      <!-- Streaming username and password settings -->
    </credentials>
  </service>
  <!-- <service> elements blocks for other streaming services -->
</streaming>
```

Attributes

Attribute	Optional/Required	Description
customizable-url	Optional	The service supports specifying custom URLs - supported = "true" or unsupported = "false" (default)

Child Elements

Element	Optional/Required	Description
<name>	Required	The name of the streaming service
<key>	Optional	The stream key for the streaming service
<servers>	Optional	The RTMP/SRT server settings of the streaming service (see below). May be omitted if customizable-url is true.
<profiles>	Required	The quality settings of the streaming service (see below)
<credentials>	Optional	The username and password of the streaming service (see below)

Servers Element

The <servers> element consists of 1 or more <server> child elements for defining the streaming server(s). The <servers> element is a required child of the <service> element. Defining multiple servers allows specifying localized and/or backup servers within a single XML description

The following is an example of a <servers> element block that defines a primary and secondary URL for the SRT server.

```
<service>
  ...
  <servers>
    <server group="Primary">
      <name>My Streaming Service Server</name>
      <url>srt://srt.my-streaming-service.com:2010</url>
      <srt-extensions>
        ...
      </srt-extensions>
    </server>
    <server group="Secondary">
      <name>My Streaming Service Backup Server</name>
      <url>srt://srt-backup.my-streaming-service.com:2010</url>
      <srt-extensions>
        ...
      </srt-extensions>
    </server>
    <!-- Additional <server> element blocks defining other
servers for streaming service -->
  </servers>
  ...
</service>
```

Attributes

Attribute	Optional/Required	Description
group	Optional	The logical grouping for the server

Child Elements

Element	Optional/Required	Description
<name>	Required	The name of the RTMP/SRT streaming server
<url>	Required	The URL of the RTMP/SRT streaming server
<srt-extensions>	Optional	Extended service block specific to SRT streaming server (see below)

SRT Extensions Element

The <srt-extensions> element consists of 1 or more child elements that define SRT specific parameters.

The following is an example of a <srt-extensions> element block for a primary stream identifier.

```
<service>
  ...
  <servers>
    <server group="Primary">
      ...
      <srt-extensions>
        <stream-id>
          <item key="copy" value="0"/>
        </stream-id>
      </srt-extensions>
    </server>
  </servers>
  ...
</service>
```

Child Elements

Element	Optional/Required	Description
<stream-id>	Required	Provides element with custom parameters for the stream ID. Each child element of stream-id has 1 or more item elements with a key/value pair.

Profiles Element

The <profiles> element consists of 1 or more <profile> child elements that define streaming quality. The <profiles> element is a required child of the <service> element. Defining multiple profiles allows specifying custom bitrates for different streaming qualities.

The following is an example of a <profiles> element block that defines 3 profiles.

```
<service>
  ...
  <profiles default="Streaming High">
    <profile>
      <name>Streaming High</name>
      <!-- Define <config> elements to specify target
bitrates for Streaming High profile -->
    </profile>
    <profile>
      <name>Streaming Medium</name>
      <!-- Define <config> elements to specify target
bitrates for Streaming Medium profile -->
    </profile>
  </profiles>
  ...
</service>
```

Attributes

Attribute	Optional/Required	Description
default	Optional	The name of the default profile

Child Elements

Element	Optional/Required	Description
<name>	Required	The name of the profile
<config>	Required	Video mode dependent quality settings for profile (see below)

Config Element

The <config> element defines a mapping between the video resolution and frame rate and the target bitrate for the quality level. The <config> element is a child of the <profile> element.

The following is an example of a <config> element block for setting the target bitrate for a high quality stream with 720p60 and 1080p60 video inputs.

```
<profile>
  <name>Streaming High</name>
  <config resolution="720p" fps="60" codec="H264">
    <bitrate>6000000</bitrate>
    <audio-bitrate>128000</audio-bitrate>
  </config>
  <config resolution="1080p" fps="60" codec="H264">
    <bitrate>8000000</bitrate>
    <audio-bitrate>128000</audio-bitrate>
  </config>
  <!-- <config> elements for other resolutions and frame rates -->
</profile>
```

Attributes

Attribute	Optional/Required	Description
resolution	Required	The resolution of the streaming video mode
fps	Required	The frame rate of the streaming video mode (frames per second)
codec	Optional	The codec for encoding the streaming video - "H264" (default) or "H265"

Child Elements

Element	Optional/Required	Description
<bitrate>	Required	The target bitrate of the streaming video (bits per second)
<audio-bitrate>	Optional	The target bitrate of the streaming audio (bits per second)

The supported streaming quality bitrates can be found in section `Using Web Presenter Setup` section earlier in this manual.

TIP For each <config> element block, choose a maximum resolution and fps to cover all video modes for the target bitrate. For example, defining a <config> element with resolution="1080p" and fps = "30" will apply for video modes 1080p23.98, 1080p24, 1080p25, 1080p29.97 and 1080p30.

For audio bitrate, only 128 Kb/s is supported.

Credentials Element

The <credentials> element allows specifying an RTMP session username and password if required by the service. The <credentials> element is an optional child to service element.

The following is an example of a <credentials> element block that defines a username and password for the streaming service.

```
<service>
  ...
  <credentials>
    <username>myusername</username>
    <password>abcd1234</password>
  </credentials>
  ...
</service>
```

Child Elements

Element	Optional/Required	Description
<username>	Required	RTMP session username
<password>	Required	RTMP/SRT session password

도움말

지원 받기

가장 빠르게 지원 받을 수 있는 방법은 Blackmagic Design 온라인 고객지원 페이지에 접속하여 Blackmagic Web Presenter 관련 최신 지원 정보를 이용하는 것입니다.

Blackmagic Design 온라인 고객 지원 페이지

Blackmagic 고객 지원 센터(www.blackmagicdesign.com/kr/support)에서 최신 사용 설명서를 확인할 수 있습니다.

Blackmagic Design 포럼

저희 웹사이트에 있는 Blackmagic Design 포럼은 유용한 정보를 제공하는 곳으로 방문을 통해 자세한 정보와 창의적인 아이디어를 얻을 수 있습니다. 또한 숙련된 사용자나 Blackmagic Design 직원들이 기존에 제공한 해결책을 통해 원하는 해답을 얻을 수도 있어 빠르게 문제 해결을 통해 제품 사용을 이어갈 수 있습니다.

<http://forum.blackmagicdesign.com/kr>에서 포럼에 방문할 수 있습니다

Blackmagic Design 고객 지원에 문의하기

고객 지원 페이지나 포럼에서 원하는 정보를 얻지 못한 경우에는 '이메일 보내기' 버튼을 클릭하여 지원 요청 이메일을 보내주세요. 다른 방법으로는 고객지원 페이지의 '지역별 고객 지원팀 찾기' 버튼을 클릭하여 가장 가까운 Blackmagic Design 고객지원 사무실에 문의하세요.

규제 사항



유럽 연합 국가 내의 전기전자제품 폐기물 처리 기준.

제품에 부착된 기호는 해당 제품을 다른 폐기물과는 별도로 처리되어야 함을 나타냅니다. 제품을 폐기하려면 반드시 재활용 지정 수거 장소에 폐기해야 합니다. 폐기물 제품을 분리수거 및 재활용으로 처리하는 것은 자연 자원을 보전하고 인간의 건강과 환경을 보호할 수 있도록 폐기물을 재활용할 수 있는 방법입니다. 재활용을 위한 제품 폐기물 장소에 관한 자세한 정보는 해당 지역 시청의 재활용 센터 혹은 해당 제품을 구입한 상점으로 문의하십시오.



본 제품은 테스트 결과 FCC 규정 제15항에 따라 A급 디지털 기기 제한 사항을 준수하는 것으로 확인되었습니다. 해당 제한 사항은 본 제품을 상업적 환경에서 사용할 시 발생할 수 있는 유해 혼선으로부터 적절한 보호를 제공하기 위함입니다. 이 제품은 무선 주파수를 생성 및 사용, 방출할 수 있습니다. 따라서 설명서의 안내에 따라 제품을 설치 및 사용하지 않을 시, 무선 통신을 방해하는 전파 혼선을 일으킬 수 있습니다. 해당 제품을 주거 지역에서 작동할 경우 유해 전파 혼선이 발생할 가능성이 있으며, 이 경우 사용자는 자체 비용으로 전파 혼선 문제를 해결해야 합니다.

제품 작동은 다음 두 가지 조건을 전제로 합니다.

- 1 본 기기는 유해 혼신을 일으키지 않습니다.
- 2 본 기기는 원치 않는 동작을 유발할 수 있는 혼신을 포함한 수신 되는 모든 혼신을 수용해야 합니다.



R-R-BMD-20201201001
R-R-BMD-20201201002



ISED 캐나다 성명

본 기기는 캐나다 표준 A급 디지털 장치 규정을 준수합니다.

정해진 사용 목적 이외의 다른 목적의 사용 또는 제품 변경은 표준 규정 위반으로 간주할 수 있습니다.

HDMI 인터페이스 연결 시에는 반드시 고품질의 실드 HDMI 케이블을 사용해야 합니다.

이 기기는 업무용 환경에서 사용할 목적으로 적합성 평가를 받은 기기로서 가정용 환경에서 사용하는 경우 전파 간섭의 우려가 있습니다.

안전 정보

본 장비는 반드시 보호 접지가 되어있는 메인 콘센트에 연결해야 합니다.

감전사고 위험을 줄이기 위해서 본 제품을 물이 튀거나 젖는 곳에 두지 마십시오.

본 장비는 주위 온도가 최대 40°C인 열대 지역에서 사용하기 적합합니다.

보관 온도 범위는 -20°C에서 60°C이며 상대 습도는 0% ~ 90% 비응결입니다.

공기가 잘 통할 수 있도록 제품을 통풍이 잘되는 곳에 둡니다.

장비랙에 제품을 설치할 시, 주변 장비가 제품 통풍에 방해가 되지 않도록 주의하세요.

제품 내부에는 사용자가 수리 가능한 부품이 없습니다. 제품 수리는 해당 지역 Blackmagic Design 서비스 센터에 문의하세요.



최대 작동 고도는 해수면 기준 2000m입니다.

캘리포니아주 성명

본 제품을 사용하는 사용자는 제품의 플라스틱 내 폴리브롬화 비페닐에 노출될 수 있으며 캘리포니아주에서는 해당 물질이 암, 선천적 결손증, 기타 생식기능의 손상을 유발하는 것으로 알려져 있습니다.

더욱 자세한 정보는 www.P65Warnings.ca.gov를 확인하세요.

보증

36개월 한정 보증

Blackmagic Design은 Blackmagic Web Presenter 제품의 부품 및 공정 기술에 결함이 없음을 구매일로부터 36개월 동안 보증합니다. 그러나, 커넥터, 케이블, 냉각팬, 광섬유 모듈, 퓨즈, 키보드, 배터리의 부품 및 공정 기술에 대한 보증 기간은 구매일로부터 12개월입니다. 보증 기간 내에 결함이 발견될 경우, Blackmagic Design은 당사의 결정에 따라 무상 수리 또는 새로운 제품으로 교환해드립니다.

구매 고객은 반드시 보증 기간이 만료되기 전에 결함 사실을 Blackmagic Design에 통지해야 적절한 보증 서비스를 제공받을 수 있습니다. 구매 고객은 지정된 Blackmagic Design 서비스 센터로 결함 제품을 포장 및 운송할 책임이 있으며, 운송 비용은 선불로 지급되어야 합니다. 구매 고객은 또한 이유를 불문하고 제품 반송에 대한 운송료, 보험, 관세, 세금, 기타 비용을 부담해야 합니다.

이 보증은 부적절한 사용, 관리 및 취급으로 인한 파손, 고장, 결함에는 적용되지 않습니다. Blackmagic Design은 다음과 같은 경우에 보증 서비스를 제공할 의무가 없습니다. a) Blackmagic Design 판매 대리인이 아닌 개인에 의해 발생한 제품 손상. b) 부적절한 사용 및 호환하지 않는 장비와의 연결로 인한 제품 손상. c) Blackmagic Design사의 부품 및 공급품이 아닌 것을 사용하여 발생한 손상 및 고장. d) 제품을 개조하거나 다른 제품과 통합하여 제품 작동 시간 증가 및 기능 저하가 발생한 경우. Blackmagic Design에서 제공하는 제품 보증은 다른 모든 명시적 또는 묵시적 보증을 대신합니다. Blackmagic Design과 관련 판매 회사는 상품성 및 특정 목적의 적합성과 관련된 모든 묵시적 보증을 부인합니다. 구매 고객에게 제공되는 BLACKMAGIC DESIGN의 결함 제품 수리 및 교환 관련 책임은 유일한 배상 수단입니다. BLACKMAGIC DESIGN은 자사 또는 판매 회사에서 관련 위험의 가능성에 대한 사전 통보의 여부와 관계없이 모든 간접적, 특별, 우발적, 결과적 손해에 대해 책임지지 않습니다. Blackmagic Design은 장비의 불법적 사용과 관련하여 어떤 법적 책임도 지지 않습니다. BLACKMAGIC은 본 제품의 사용으로 인해 발생하는 손해에 대해서는 어떤 법적 책임도 지지 않습니다. 제품 사용으로 인해 발생할 수 있는 위험에 대한 책임은 본인에게 있습니다.

© Copyright 2023 Blackmagic Design. 모든 저작권은 Blackmagic Design에게 있습니다. 'Blackmagic Design', 'DeckLink', 'HDLink', 'Workgroup Videohub', 'Multibridge Pro', 'Multibridge Extreme', 'Intensity', 'Leading the creative video revolution'은 모두 미국 및 기타 국가에 등록된 상표입니다. 다른 회사명 및 제품 이름은 관련 회사의 등록 상표일 수 있습니다.

Thunderbolt와 Thunderbolt 로고는 미국 및 기타 국가에서 등록된 Intel Corporation의 상표입니다.

Сентябрь 2023 г.

Руководство по установке и эксплуатации

Blackmagicdesign

Blackmagic Web Presenter



Blackmagic Web Presenter



Уважаемый пользователь!

Благодарим вас за покупку устройства Blackmagic Web Presenter!

Данное решение можно напрямую подключать к любому SDI-оборудованию, использовать для преобразования сигнала в формат H.264 и потоковой трансляции на таких популярных платформах, как YouTube Live, Facebook Live и Twitch. Кроме того, для онлайн-показа видео в вещательном качестве допускается применение конвертера ATEM Streaming Bridge. Это позволяет передавать профессиональный контент через Интернет в самые удаленные места.

Данное руководство содержит всю необходимую информацию о функциях и настройках устройства Blackmagic Web Presenter, а также о том, как подготовить его для стриминга на онлайн-платформах (YouTube Live, Facebook Live, Twitch) и работы с приложениями Zoom и Skype.

Последнюю версию руководства и программного обеспечения для Blackmagic Web Presenter можно найти в разделе поддержки на веб-сайте www.blackmagicdesign.com/ru. Чтобы узнавать о выходе обновлений, зарегистрируйтесь при загрузке ПО.

Мы продолжаем работать над совершенствованием наших продуктов, поэтому ваши отзывы помогут нам сделать их еще лучше!

Грант Петти

Генеральный директор Blackmagic Design

Содержание

Подготовка к работе	376
Передняя панель на Blackmagic Web Presenter	379
ЖК-дисплей	380
Выход для мониторинга	381
Работа с утилитой Web Presenter Setup	386
Вкладка Live Stream (Потоковая трансляция)	387
Вкладка Setup (Настройка)	390
Сетевые параметры	391
Настройка общего доступа к Интернету для прямой потоковой трансляции	391
Стриминг с помощью смартфона	392
Использование Blackmagic Web Presenter в качестве веб-камеры	392
Настройка приложения Open Broadcaster	392
Создание видеоканалов с помощью ATEM Streaming Bridge	395
Создание XML-файла	396
Экспорт XML-файла	396
Tally-индикация, интерком-связь и управление камерой	397
Подключение камеры URSA Broadcast G2	398
Blackmagic Universal Rack Shelf	399
Содержание	399
Установка устройства на полке Universal Rack Shelf	400
Порядок установки заглушки 1/6 RU	400
Порядок установки боковой заглушки 1/3 RU	400
Обновление встроенного программного обеспечения	401
Developer Information	402
Blackmagic Web Presenter Ethernet Protocol	402
Protocol Blocks	404
Blackmagic Streaming XML Format	415
Overview	415
Streaming XML Definition	415
Помощь	422
Соблюдение нормативных требований	423
Правила безопасности	424
Гарантия	425

Подготовка к работе

Blackmagic Web Presenter является простым в эксплуатации устройством. Чтобы приступить к работе, достаточно подключить питание, источник видео- и аудиосигнала, а также подсоединить устройство к компьютеру и Интернету.

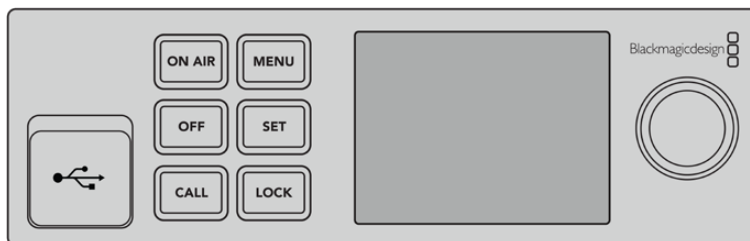

Передняя панель на Blackmagic Web Presenter

Подключение питания

Подключите силовой кабель по стандарту IEC к разъему на задней панели устройства Blackmagic Web Presenter.

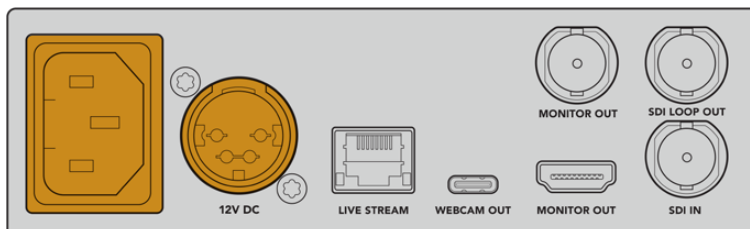

Питание на Blackmagic Web Presenter может поступать через разъем стандарта IEC или гнездо питания 12 В постоянного тока

На Web Presenter также есть гнездо питания 12 В постоянного тока. Его можно использовать для дополнительных источников питания (например, внешней батареи 12 В или блока бесперебойного энергоснабжения).

Подключение источника видео- и аудиосигнала

Подключите источник видеосигнала к SDI-входу на Blackmagic Web Presenter. На встроенном ЖК-дисплее появится изображение. Через SDI-вход видео передается вместе с аудиосигналом, который можно отслеживать с помощью индикаторов звука на ЖК-дисплее.

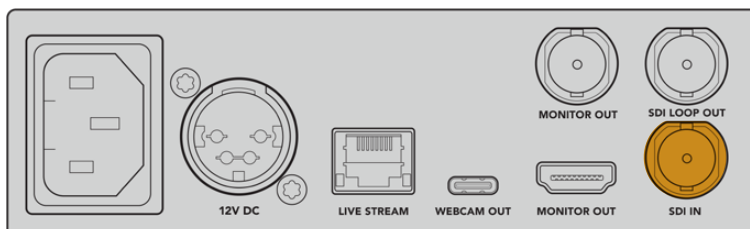

Подключите источник видеосигнала к SDI-входу на Blackmagic Web Presenter

Blackmagic Web Presenter поддерживает технологию 12G-SDI и автоматически переключается между HD и Ultra HD вплоть до 2160p/60 при изменении поступающего видеосигнала. Blackmagic Web Presenter 4K может вести потоковую трансляцию в Ultra HD, а на модели Blackmagic Web Presenter HD предусмотрена понижающая конверсия контента до разрешения 1080p.

Подключение к монитору

Подключите HDMI-телевизор или SDI-дисплей к одному из выходов для мониторинга. Это позволит просматривать транслируемый материал и важную служебную информацию, которая во время стриминга постоянно обновляется. Подробнее см. раздел «Выход для мониторинга».

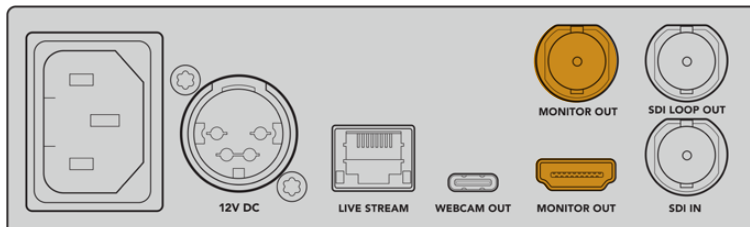

Подключите дисплей к выходу для мониторинга на Web Presenter

Подключение к компьютеру через USB

Подключите Web Presenter к компьютеру через порт USB-C, расположенный на передней или задней панели. Эти разъемы используют для обновления и настройки устройства с помощью утилиты Blackmagic Web Presenter Setup. После завершения установки параметров Web Presenter можно от компьютера отсоединить.

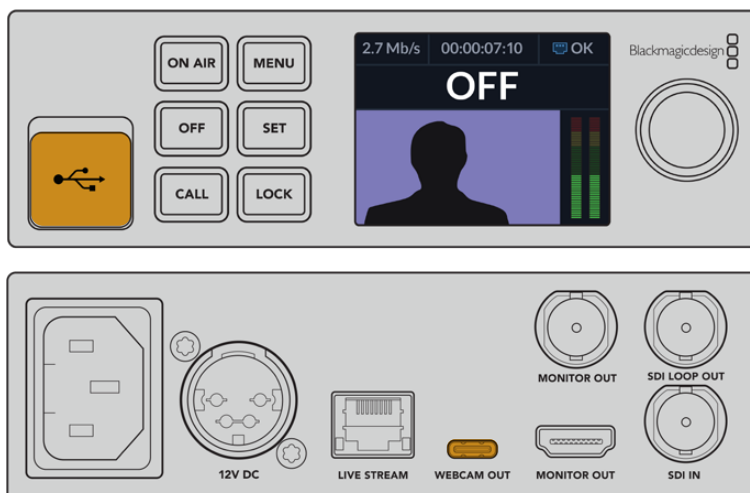

Подключите Blackmagic Web Presenter к компьютеру через порт USB, расположенный на передней или задней панели

Подключение к Интернету

Чтобы получить доступ к Интернету, подключите Blackmagic Web Presenter кабелем к сетевому маршрутизатору или коммутатору через Ethernet-порт LIVE STREAM.

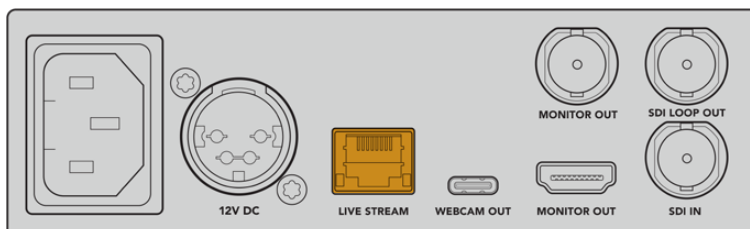

Подключите Blackmagic Web Presenter к сети через Ethernet-порт, расположенный на задней панели

Установка параметров потоковой трансляции

Web Presenter позволяет вести потоковую трансляцию на любой подходящей платформе, в том числе YouTube Live, Facebook Live и Twitch. В данном случае подготовим устройство для стриминга на сервисе YouTube Live.

- 1 Скопируйте ключ трансляции из своего аккаунта YouTube Studio.
- 2 Загрузите утилиту Blackmagic Web Presenter Setup в разделе поддержки по адресу www.blackmagicdesign.com/ru/support и установите ее на компьютере. Она позволяет задать первоначальные настройки стриминга.
- 3 Откройте утилиту Blackmagic Web Presenter Setup и перейдите на страницу Live Stream.
- 4 Выберите платформу YouTube и сервер Primary. Вставьте ключ трансляции YouTube в поле Key и укажите качество стриминга. Нажмите Save.
- 5 Все готово к началу потоковой трансляции. Нажмите кнопку ON AIR в диалоговом окне или на передней панели устройства. Для остановки вещания нажмите кнопку OFF.

Работа с протоколом SRT

Протокол SRT обеспечивает потоковую передачу со сниженной задержкой по сравнению с технологией RTMP, а также повышает общую безопасность за счет наличия кодовой фразы, которая используется как ключ шифрования.

При выборе версии протокола SRT стримингового сервиса скопируйте кодовую фразу (Passphrase) и ключ трансляции (Key) из своей учетной записи. Затем вставьте эти данные в соответствующие поля в утилите Blackmagic Web Presenter Setup.

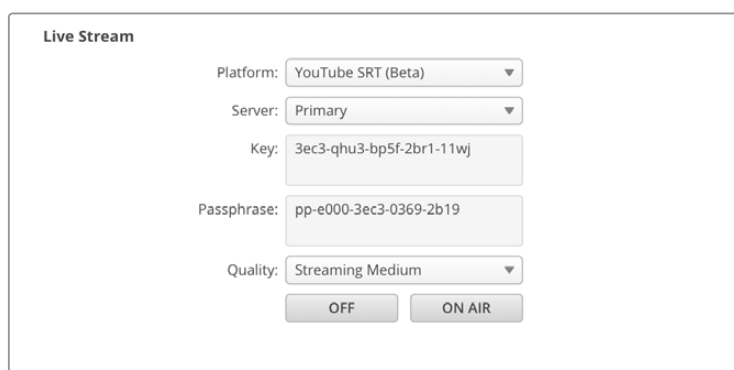

The screenshot shows a configuration window titled "Live Stream". It contains the following fields and controls:

- Platform: YouTube SRT (Beta) (dropdown menu)
- Server: Primary (dropdown menu)
- Key: 3ec3-qhu3-bp5f-2br1-11wj (text input field)
- Passphrase: pp-e000-3ec3-0369-2b19 (text input field)
- Quality: Streaming Medium (dropdown menu)
- Two buttons at the bottom: OFF and ON AIR.

Вставьте кодовую фразу в соответствующее поле в утилите

Как протокол RTMP или SRT, так и кодек H.264 либо H.265 можно изменить в XML-файле, если технические специалисты хотят самостоятельно настроить параметры стриминга. Подробнее см. соответствующий раздел.

Передняя панель на Blackmagic Web Presenter

На передней панели расположены органы управления, с помощью которых можно изменять настройки, а также начинать и прекращать стриминг.

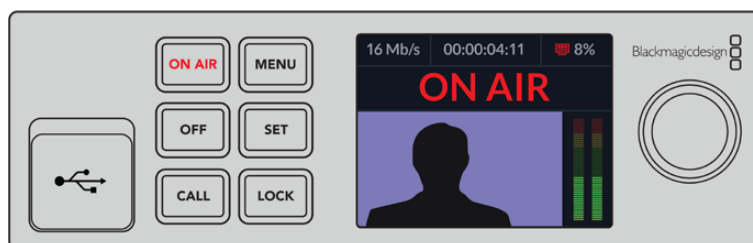

ON AIR. Данную кнопку используют для включения стриминга. Когда сигнал идет в эфир, она горит красным цветом.



Если кнопка ON AIR мигает, потоковая трансляция не включилась или неожиданно прекратилась. Причиной этому может быть сбой интернет-соединения или неправильные настройки стриминга. Если нужно, проверьте их и внесите необходимые коррективы.

OFF. Данную кнопку используют для выключения стриминга.

MENU. Применяется для открытия настроек на ЖК-дисплее.

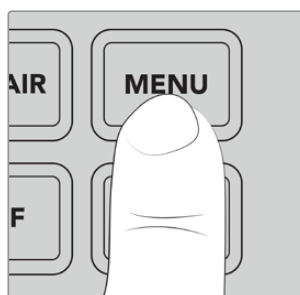

Порядок изменения настроек

- 1 Выберите настройку с помощью круглой ручки и нажмите кнопку SET.

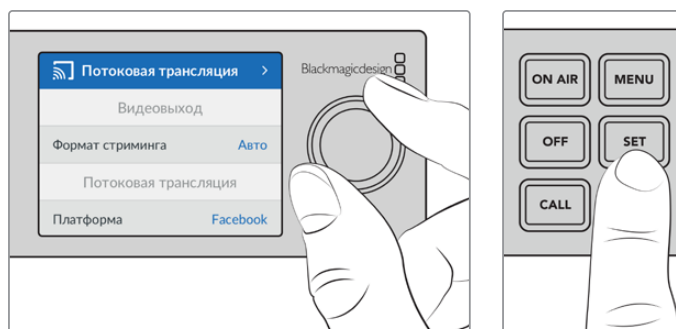

- 2 Измените настройку поворотом ручки.
- 3 Нажмите кнопку SET еще раз, чтобы подтвердить сделанный выбор.

Кнопка MENU также используется для возврата на один шаг назад вплоть до начальной страницы.

CALL. Поддержка этой функции появится после обновления ПО в будущем.

LOCK. Чтобы заблокировать панель, нажмите и удерживайте эту кнопку в течение одной секунды. Данная функция позволяет исключить вероятность случайного включения или выключения потоковой трансляции. В активированном состоянии кнопка горит красным цветом.

Чтобы разблокировать панель, нажмите и удерживайте эту кнопку в течение двух секунд.

ЖК-дисплей

При включении устройства Web Presenter на его дисплее появляется начальная страница. На ней отображается приведенная ниже информация.

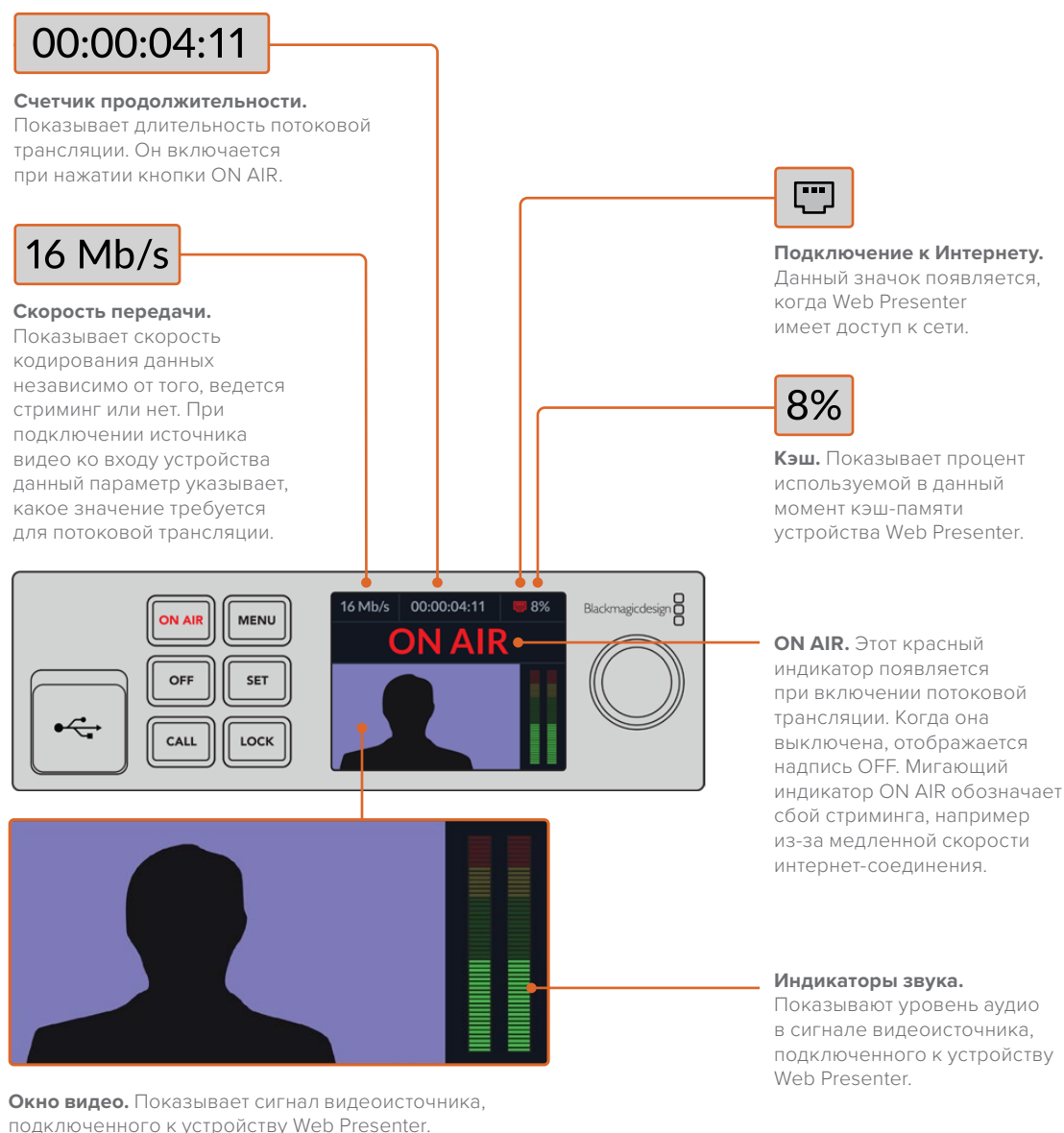

Значки подключения к Интернету



Синий значок разъема Ethernet показывает, что подсоединен Ethernet-кабель и этот порт будет использован для стриминга.



Красный значок разъема Ethernet показывает, что через данный порт ведется потоковая трансляция.



Синий значок смартфона показывает, что он будет использован для подключения к Интернету и стриминга.



Красный значок смартфона показывает, что через него ведется потоковая трансляция.

СОБЕТ. Отсутствие значка означает, что Web Presenter не имеет доступа к сети.

Выход для мониторинга

Выход для мониторинга позволяет выводить на дисплей входящий видеосигнал, индикаторы звука, состояние эфира и скорость передачи данных, а также степень заполнения кэш-памяти и служебную информацию, поступающую через порт SDI.



Предусмотренный на Blackmagic Web Presenter выход для мониторинга обеспечивает вывод всей необходимой информации, в том числе скорости передачи данных и состояния кэш-памяти

Для упорядоченного вывода данных дисплей разбит на восемь секций. Описание информации, отображаемой в каждой из них, приведено ниже.

Окно источника

В основном окне отображается видео из источника, подключенного к порту SDI.



Индикатор эфира

Когда запись выключена, индикатор показывает OFF. Это означает, что устройство Web Presenter находится в режиме ожидания и готово к трансляции. Как только начинается стриминг, появляется красная надпись ON AIR. Она исчезает, когда вещание прекращается.



Под индикатором эфира находится счетчик продолжительности. Он включается при нажатии кнопки ON AIR на Web Presenter.

Если устройство Web Presenter не передает сигнал в эфир, но подключено к Интернету через смартфон, в окне отображается надпись OFF, а в его верхнем углу появляется синий значок смартфона. При включении стриминга он становится красным.

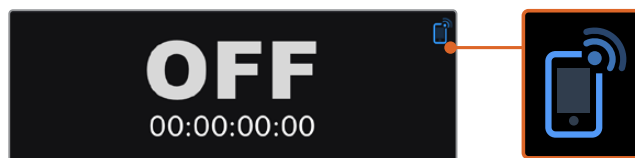

Потоковая трансляция

На этой панели отображается информация о настройках прямой трансляции, включая данные о стриминговой платформе, сервере, протоколе, а также параметрах разрешения и качества изображения.

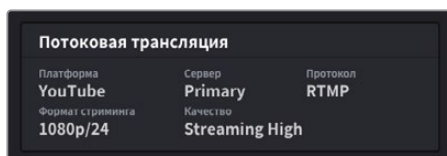

Видеовход

В верхней части этого окна приведены пять миниатюрных кадров (1,2 секунды каждый), показанных в предыдущие шесть секунд потоковой трансляции.

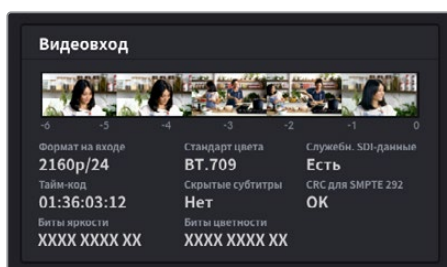

Под ними отображается подробная техническая информация об источнике видео, подключенном к SDI-входу на Web Presenter.

Формат на входе	Показывает разрешение и кадровую частоту видео, поступающего через SDI-вход. Web Presenter поддерживает сигнал вплоть до 2160p/60.
Стандарт цвета	Отображает цветовое пространство видео, поступающего через SDI-вход. Web Presenter поддерживает стандарты Rec.601, Rec.709 и Rec.2020.
Служебные SDI-данные	Показывает дополнительную информацию, поступающую вместе с SDI-видео. Сюда могут входить звук, тайм-код и скрытые субтитры. Если в сигнале такие данные присутствуют, в окне будет отображаться «Есть».
Тайм-код	Отображает тайм-код видео, поступающего через SDI-вход.
Скрытые субтитры	Если поступающий видеосигнал содержит скрытые субтитры, будет показан их формат (CEA-608 или CEA-708).
CRC для SMPTE 292	Функция для проверки наличия нарушений в видеосигнале, поступающем через SDI-вход. Если Web Presenter обнаруживает сбой, в окне отображается «Ошибка». Это обычно происходит из-за неисправного или слишком длинного SDI-кабеля.
Биты яркости и биты цветности	<p>Данные индикаторы показывают состояние видеопотока, поступающего через SDI-вход. Каждая буква обозначает отдельный бит сигнала.</p> <p>X — постоянно меняющийся бит.</p> <p>L — низкий бит.</p> <p>H — высокий бит.</p> <p>Чтобы упростить информацию, смещения сигнала SDI вычитаются. Например, все биты являются низкими, когда изображение черное.</p> <p>Обычно, когда 10 битов видеосигнала представлены буквой X, это означает, что они все постоянно меняются. Если входящий SDI-поток является 8-битным, два правых бита будут показаны буквой L, поскольку не несут никакой информации. Когда бит представлен буквой L или H, хотя ожидается X, это означает, что бит «застрял». Такое может происходить при наличии сбоя в поступающем видеосигнале.</p>

Аудиовход

В верхней части этого окна находится волновая диаграмма звука. Она показывает данные за последние шесть секунд потоковой трансляции. Они постоянно обновляются и перемещаются справа налево.

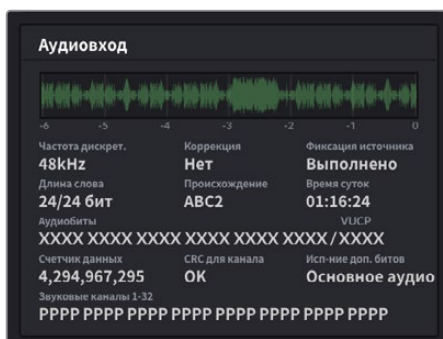

Под волновой диаграммой звука приведена подробная техническая информация о поступающем аудиосигнале.

Частота дискретизации	Показывает частоту дискретизации звука, встроенного в SDI-сигнал.
Коррекция	Указывает, применяется ли данная опция к исходному сигналу.
Фиксация источника	Показывает, привязана ли частота исходного звука ко внешнему опорному сигналу.
Длина слова	Отображает битовую глубину звука, встроенного в SDI-сигнал.
Происхождение	Эти четыре знака указывают происхождение канала.
Время суток	Независимы тайм-код.
Аудиобиты	Показывает состояние битов в звуковых сэмплах, встроенных в SDI-сигнал. Даже если указано, что аудиоканал является 16-, 20- или 24-битным, это будет подтверждено данным индикатором.
VUCP	Звуковые данные по VUCP: бит достоверности отсчета (V), бит данных пользователя (U), бит статуса канала (C) и бит четности (P).
Счетчик данных	Счетчик аудиоданных.
Использование дополнительных битов	Показывает, используются ли дополнительные биты в основном аудиоканале.
Звуковые каналы 1-32	Каждый знак обозначает аудиоканал, встроенный в сигнал на SDI-входе. Буква P указывает на то, что данный канал используется, а символ "-" показывает, что звук отсутствует.

Индикатор скорости передачи данных

В этом окне отображается текущая скорость кодирования данных за последние 60 секунд. Она измеряется в мегабитах в секунду. Индикатор работает даже при выключенном эфире, что позволяет точно измерить пропускную способность перед началом вещания.

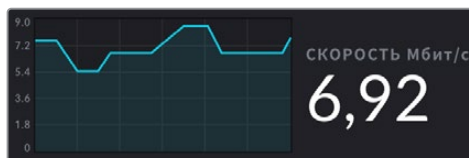

Индикатор кэш-памяти

В этом окне отображается процент кэш-памяти устройства Web Presenter, задействованной в данный момент, а на графике показан объем, использованный за последние 60 секунд. Кэш — это небольшая внутренняя память, которая постоянно записывает и воспроизводит программный контент. Она приходит на выручку в тех случаях, когда скорость передачи данных становится настолько низкой, что не в состоянии обеспечить устойчивую трансляцию видео.

Вследствие постоянного изменения активности сети и колебания силы беспроводного сигнала передача информации в Интернете имеет переменный характер. Поэтому объем данных в буфере увеличивается по мере уменьшения скорости вещания. Если скорость соединения становится слишком низкой, чтобы поддерживать видеопоток, объем данных в буфере увеличивается. Как только кэш заполнится на 100%, видеопоток будет ослаблен, поэтому этого по возможности следует избегать. Чтобы выполнить тестирование, можно подключить источник видео и понаблюдать за состоянием памяти без включения стриминга. Если значение часто приближается к 100%, переключитесь на более низкое качество изображения.

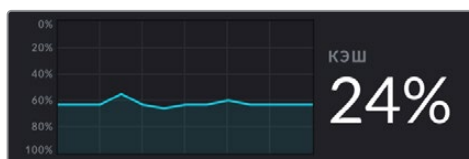

Индикаторы звука

Мониторинг уровня исходного аудиосигнала выполняют с помощью индикаторов звука. Для них в настройках меню устройства можно выбрать шкалу PPM или VU. Если уровень аудио слишком высокий, загораются красные сегменты. Это может привести к искажению или клиппингу звука во время потоковой трансляции. Для получения оптимальных результатов значения должны находиться в пределах зеленого и желтого сегментов.

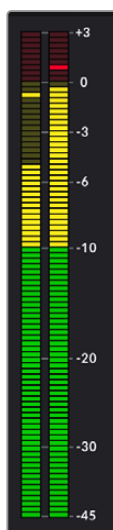

Работа с утилитой Web Presenter Setup

Когда решение Blackmagic Web Presenter подключено к сети, его можно контролировать в удаленном режиме с помощью любого компьютера, находящегося в этой же сети. Приложение Blackmagic Web Presenter Setup позволяет получить доступ к тем же настройкам и элементам управления, которые расположены на передней панели самого устройства.

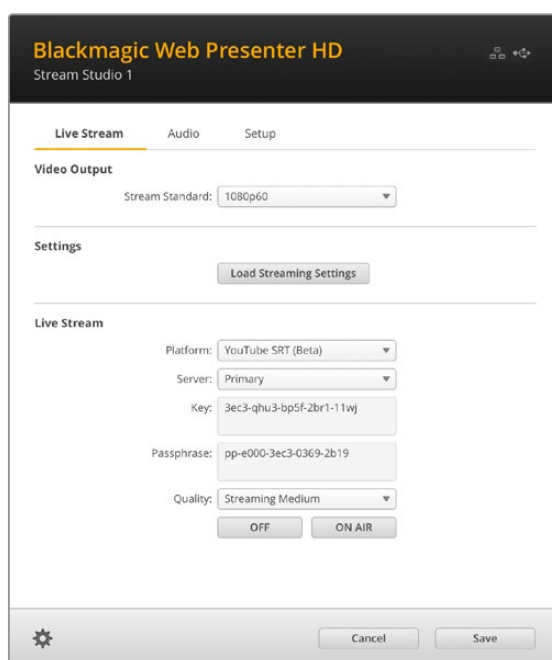
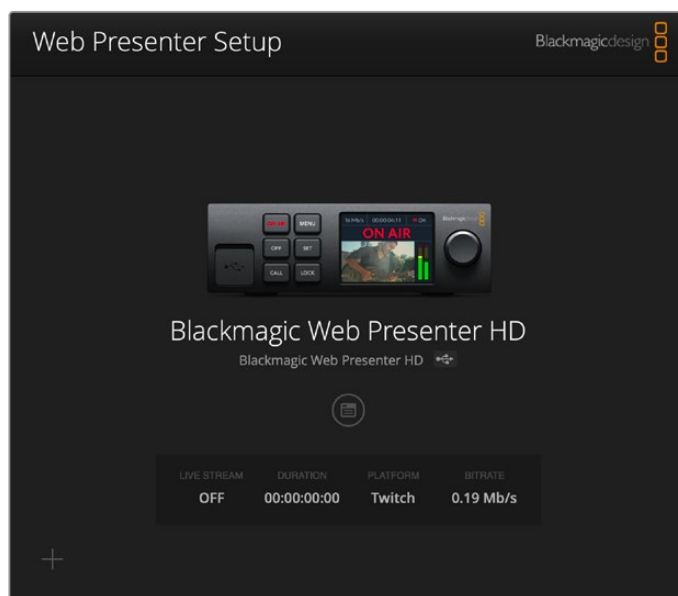

Вкладка Live Stream (Потоковая трансляция)

Video Output (Вывод видео)

Stream Standard (Формат стриминга)

В меню Stream Standard можно задать разрешение видео для потоковой трансляции. Доступны значения от 720p/25 до 1080p/60 или 2160p/60 в зависимости от используемой модели Web Presenter.

Settings (Настройки)

Если необходимо применить пользовательские настройки стриминга, например из файла XML конвертера ATEM Streaming Bridge, их можно импортировать, нажав кнопку Load Streaming Settings.

Подробнее о создании пользовательских настроек и подключении к конвертеру ATEM Streaming Bridge см. раздел «Создание видеоканалов с помощью ATEM Streaming Bridge» ниже.

Live Stream (Потоковая трансляция)

Platform (Платформа)

Данное меню позволяет выбрать стриминговый сервис для трансляции. Доступны Facebook, YouTube и Twitch. Если импортированы дополнительные настройки, они также будут отображены в списке платформ.

Чтобы выполнить потоковую передачу на пользовательский URL-адрес, выберите соответствующую опцию в меню Platform. Модель Web Presenter 4K поддерживает форматы H.264 и H.265, а Web Presenter HD — только H.264.

Server (Сервер)

Укажите ближайший к вашему местоположению сервер. Доступные варианты будут зависеть от выбранной стриминговой платформы.

При потоковой передаче в Instagram, Microsoft Teams или на собственный URL-адрес список серверов можно отредактировать. Введите URL-адрес из учетной записи на стриминговой платформе или пользовательские данные.

Key (Ключ)

Введите ключ трансляции, выданный стриминговой платформой.

Passphrase (Кодовая фраза)

При использовании стримингового сервиса с протоколом SRT введите кодовую фразу, присвоенную учетной записью выбранной платформы.

Quality (Качество)

Выберите качество для стриминга в HD или 4K. Доступные параметры зависят от используемой модели Web Presenter.

H.264	
HD	4K
HyperDeck High: от 45 до 70 Мбит/с	HyperDeck High: от 95 до 220 Мбит/с
HyperDeck Medium: от 25 до 45 Мбит/с	HyperDeck Medium: от 66 до 150 Мбит/с
HyperDeck Low: от 12 до 20 Мбит/с	HyperDeck Low: от 38 до 80 Мбит/с
Streaming High: от 6 до 9 Мбит/с	Streaming High: от 34 до 51 Мбит/с
Streaming Medium: от 4,5 до 7 Мбит/с	Streaming Medium: от 23 до 35 Мбит/с
Streaming Low: от 3 до 4,5 Мбит/с	Streaming Low: от 13 до 20 Мбит/с

H.265	
HD	4K
Streaming High: от 2,3 до 4,5 Мбит/с	Streaming High: от 22,5 до 30 Мбит/с
Streaming Medium: от 1,5 до 3 Мбит/с	Streaming Medium: от 14 до 20 Мбит/с
Streaming Low: от 0,8 до 2 Мбит/с	Streaming Low: от 8 до 10 Мбит/с

Скорость передачи данных меняется в зависимости от качества трансляции, заданного на Web Presenter. Например, если выбрана опция Streaming High и изображение выводится в 1080p/24, скорость будет составлять 6 Мбит/с.

Указанная в таблице скорость передачи данных при стриминге ниже по сравнению с показателями рекордера HyperDeck. Это объясняется тем, что при трансляции контента по Интернету пропускная способность сети не такая высокая, как при записи информации на диск.

Как видно из приведенных данных, у каждого параметра есть нижняя и верхняя границы. Меньшее число используется для кадровых частот 24p, 25p и 30p, а большее — для 50p и 60p. По умолчанию применяется опция Streaming High, так как она позволяет вести стриминг очень высокого качества.

Кнопки OFF и ON AIR

Кнопка ON AIR позволяет начинать стриминг, а OFF — останавливать. Во время потоковой трансляции кнопка ON AIR горит красным цветом.

Remove Imported Settings (Удаление импортированных настроек)

Чтобы удалить все импортированные настройки стриминга, щелкните по значку шестеренки в левом нижнем углу вкладки Live Stream. Для подтверждения операции нажмите Remove.

Вкладка Audio (Аудио)

Содержит параметры для настройки мониторинга аудиосигнала и индикаторов звука.

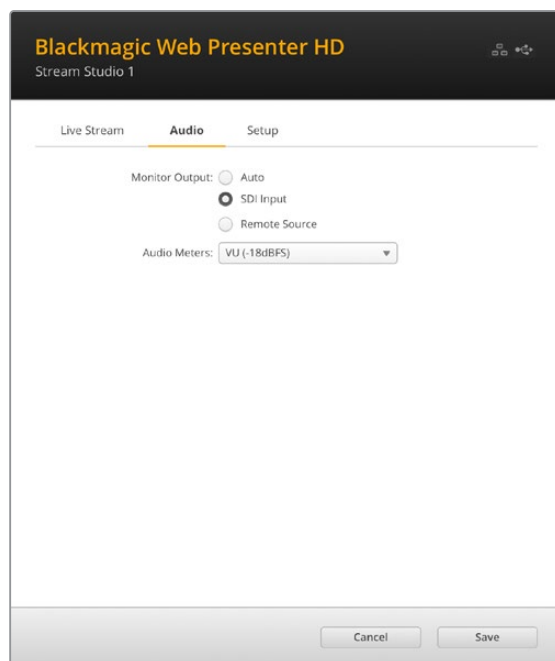

Monitor Output (Вывод данных для мониторинга)

В данном разделе можно выбрать источник звука, который выводят через SDI- или HDMI-выход мониторинга на решении Web Presenter.

Auto (Автоматически)

Выбор данной опции позволяет автоматически определять и отслеживать сигнал двусторонней связи, получаемый с видеомикшера ATEM через решение ATEM Streaming Bridge. Если он не обнаружен, будет использоваться звук со входа SDI.

SDI Input (Вход SDI)

Данная опция позволяет отслеживать звук, поступающий через SDI-вход решения Web Presenter, например с подключенной камеры Blackmagic Studio.

Remote Source (Удаленный источник)

Используйте эту опцию для мониторинга сигнала двусторонней связи, получаемого с удаленного видеомикшера ATEM или решения ATEM Streaming Bridge.

Audio Meters (Индикаторы звука)

Позволяет задать опорную шкалу для измерения уровней. Можно выбрать VU -18 dBFS, VU -20 dBFS, PPM -18 dBFS или PPM -20 dBFS.

Вкладка Setup (Настройка)

The screenshot displays the 'Setup' tab of the Blackmagic Web Presenter HD interface. At the top, there are three tabs: 'Live Stream', 'Audio', and 'Setup'. Below the tabs, the 'Name' field is set to 'Stream Studio 1', 'Language' is set to 'English', and 'Software' is set to 'Version 3.3'. The 'Network' section has a refresh icon and shows 'Protocol' set to 'Static IP' (with 'DCHP' as an option), 'IP Address' as '192.168.24.100', 'Subnet Mask' as '255.255.255.0', 'Gateway' as '192.168.24.1', 'Primary DNS' as '8.8.8.8', and 'Secondary DNS' as '8.8.4.4'. 'Connection Priority' is set to 'Mobile' (with 'Ethernet' as an option). Under the 'Reset' section, there is a 'Factory Reset' button. At the bottom of the window, there are 'Cancel' and 'Save' buttons.

Name (Имя)

Чтобы переименовать устройство, введите новое имя в поле Name и нажмите Save.

Language (Язык)

Позволяет выбрать язык настроек устройства.

Software (ПО)

Отображает текущую версию программного обеспечения устройства.

Network (Сеть)

В этой секции для подключения к сети можно выбрать протокол DHCP или статичный IP-адрес. Подробнее см. раздел «Сетевые параметры».

Connection Priority (Способ подключения). Когда устройство Web Presenter подключено к сети Ethernet и к мобильному телефону, эта настройка позволяет выбрать способ передачи сигнала во время стриминга. Подробнее см. раздел «Стриминг с помощью смартфона».

Reset (Сброс)

Чтобы выполнить сброс к заводским настройкам, нажмите кнопку Factory Reset.

Сетевые параметры

Web Presenter можно подключать к сети, используя статичный IP-адрес или протокол DHCP.

DHCP. Этот режим автоматически установит на устройстве IP-адрес и подключит его к сети без изменения каких-либо настроек.

DHCP — это протокол динамической настройки узла, используемый сетевыми серверами и маршрутизаторами для автоматического обнаружения устройства Web Presenter и присвоения ему IP-адреса. Данная функция, которой оснащено большинство компьютеров и сетевых коммутаторов, значительно облегчает подключение оборудования через Ethernet и не допускает конфликтов IP-адресов.

Static IP. Чтобы самостоятельно добавить IP-адрес, выберите протокол Static IP и введите значение вручную.

Статичный IP-адрес не изменится даже после перезагрузки Web Presenter.

Он может понадобиться при подключении устройства Web Presenter к корпоративной сети. Если в вашей компании есть системный администратор, который занимается компьютерами и сетями, лучше всего обратиться к нему, так как некоторым устройствам иногда присваивают специальные IP-адреса.

Настройка общего доступа к Интернету для прямой потоковой трансляции

Если подключить Web Presenter напрямую к сетевому коммутатору или интернет-маршрутизатору не удастся, можно предоставить устройству доступ к интернет-соединению компьютера через порт Ethernet.

Настройка устройства Blackmagic Web Presenter для прямой потоковой трансляции

- 1 Выберите для Web Presenter режим DHCP.
- 2 Измените настройки компьютера, чтобы разрешить общий доступ к Интернету через порт Ethernet.

Платформа Mac. Откройте «Системные настройки», щелкните значок «Общий доступ» и выберите «Общий Интернет» в списке «Служба». В меню «Общее подключение» выберите Wi-Fi, если компьютер подключен к Интернету через Wi-Fi. В окне «Для компьютеров, использующих» выберите Ethernet. В списке «Служба» установите флажок для опции «Общий Интернет». При появлении запроса подтвердить включение общего доступа к Интернету щелкните «Включить».

Платформа Windows. Щелкните значок «Пуск» правой кнопкой мыши и выберите «Сетевые подключения». Откроется окно «Состояние сети». Щелкните «Настройка параметров адаптера». Появится список сетевых подключений компьютера. Щелкните правой кнопкой мыши на «Подключение к Интернету» и выберите «Свойства». На вкладке «Общий доступ» установите флажок для опции «Разрешить другим пользователям сети использовать подключение к Интернету данного компьютера». В меню выберите сетевое подключение и нажмите «ОК».

- 3 Подключите Web Presenter к компьютеру через порт Ethernet. Через несколько секунд протокол DHCP присвоит устройству IP-адрес.
- 4 Когда устройство Web Presenter подключено к Интернету по локальной сети, в правом верхнем углу ЖК-дисплея устройства появится значок разъема Ethernet.

Стриминг с помощью смартфона

Blackmagic Web Presenter может использоваться для стриминга с помощью смартфона. Такой подход позволяет осуществлять вещание на мировую аудиторию из любой точки земного шара через устройство с доступом к мобильной связи.

Подключение к Интернету с помощью мобильного телефона

- 1 Подключите смартфон к Blackmagic Web Presenter с помощью кабеля USB-C. Порт USB-C находится как на передней, так и на задней панели устройства.
- 2 Включите на смартфоне режим модема.

На устройстве с операционной системой iOS откройте «Настройки» > «Режим модема» и включите опцию «Разрешать другим». На устройстве с операционной системой Android откройте быстрое меню. Нажмите и удерживайте значок Hotspot. Затем активируйте опцию USB tethering.

Теперь, чтобы начать трансляцию, на Blackmagic Web Presenter достаточно нажать кнопку ON AIR.

СОВЕТ. После завершения стриминга рекомендуется выключить режим модема, чтобы сохранить заряд батареи смартфона.

Если к Web Presenter подключен Ethernet-кабель, убедитесь, что выбрана настройка для подключения к Интернету с помощью мобильного телефона. Откройте утилиту Web Presenter Setup и перейдите на вкладку Setup. В секции Network выберите способ подключения Mobile.

Использование Blackmagic Web Presenter в качестве веб-камеры

Такие программы, как Skype или Zoom, должны автоматически использовать Web Presenter в качестве веб-камеры. При запуске приложения сразу появится поступающее с устройства видео. Если Web Presenter не выбирается автоматически, установите использование устройства в качестве веб-камеры и микрофона вручную.

Ниже описан порядок настройки при работе с приложением Skype.

- 1 В меню Skype выберите «Настройки звука и видео».
- 2 Откройте меню «Камера» и в списке выберите Web Presenter. В окне просмотра будет отображаться видео, поступающее с устройства.
- 3 Перейдите к меню «Микрофон» и выберите Web Presenter в качестве источника звука.

Настройка приложения Open Broadcaster

Open Broadcaster — это открытое приложение, которое позволяет использовать Web Presenter для показа материала на таких платформах, как YouTube, Twitch и Facebook Live. Оно сжимает видео путем уменьшения скорости цифрового потока, чтобы обеспечить его онлайн-трансляцию.

Ниже описан порядок настройки приложения Open Broadcaster для трансляции на YouTube Live, когда программный сигнал поступает с Web Presenter.

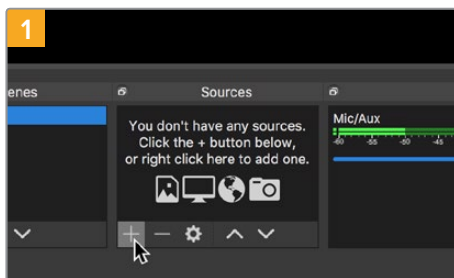

Запустите приложение Open Broadcaster и щелкните значок плюса в окне «Источники».

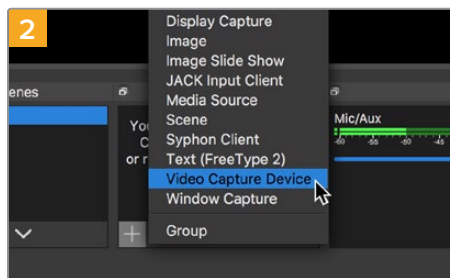

Выберите «Устройство захвата видео».

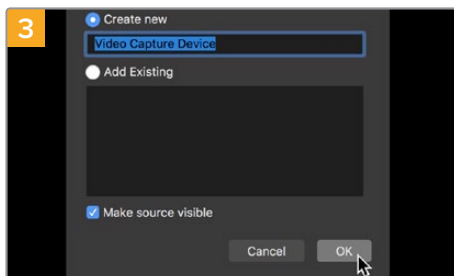

Укажите имя нового источника и нажмите «ОК».

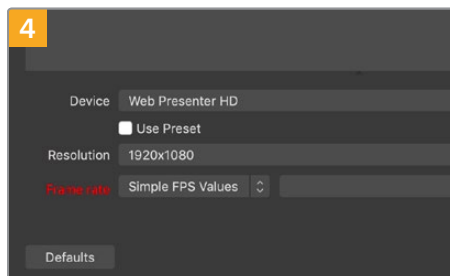

В меню «Устройство» выберите устройство Web Presenter и нажмите «ОК».

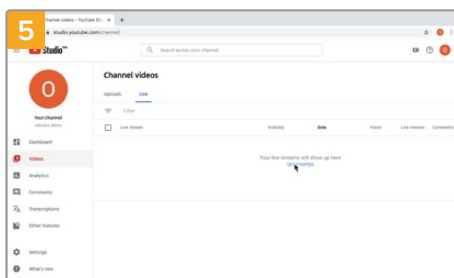

Войдите в свой аккаунт на YouTube. Нажмите кнопку «Начать трансляцию», а затем щелкните «Трансляции».

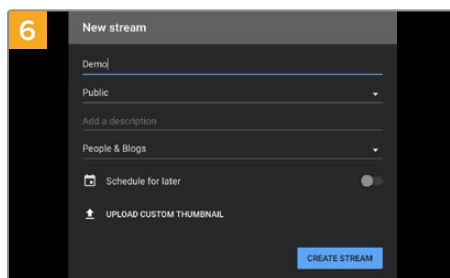

Введите данные трансляции и нажмите «СОЗДАТЬ ТРАНСЛЯЦИЮ».

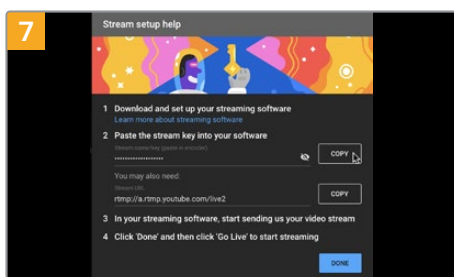

Сервис YouTube сгенерирует ключ трансляции, который подсоединит приложение Open Broadcaster к соответствующему аккаунту на платформе YouTube.

Нажмите кнопку «КОПИРОВАТЬ» рядом с ключом трансляции. Скопируйте ключ, который нужно вставить в Open Broadcaster.

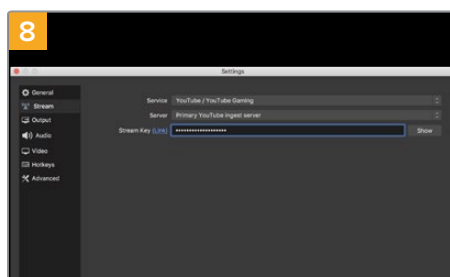

Вернитесь к приложению Open Broadcaster и откройте настройки, щелкнув меню OBS > «Настройки». Выберите «Вещание». Вставьте ключ трансляции, скопированный из YouTube, и нажмите «ОК».

В окне просмотра приложения Open Broadcaster появится видео, поступающее с Web Presenter.

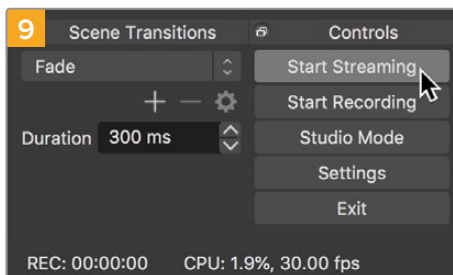

Чтобы установить канал связи между Open Broadcaster и YouTube, выберите «Запустить трансляцию» в правом нижнем углу экрана. Изображение будет поступать из Open Broadcaster на платформу YouTube Live, которая с этого момента используется для установки всех настроек.

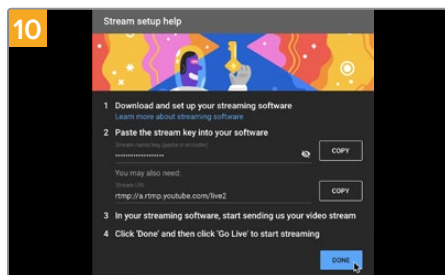

Перейдите на YouTube Live. В качестве фона должно использоваться изображение, поступающее с программного выхода устройства Web Presenter. Нажмите «Готово».

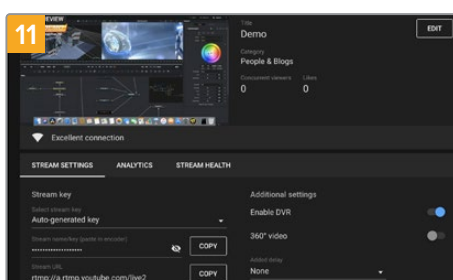

После того как между Open Broadcaster и YouTube Live установлен канал передачи изображения, все готово к трансляции. Перед ее началом рекомендуется выполнить окончательную проверку, чтобы протестировать работу оборудования.

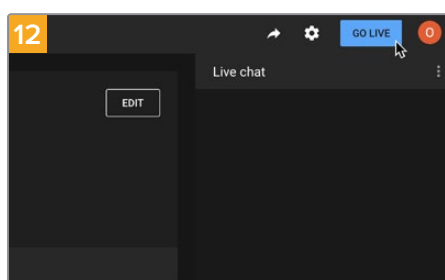

Если все в порядке, нажмите кнопку «НАЧАТЬ ТРАНСЛЯЦИЮ».

После выполнения всех описанных выше действий приложение Open Broadcaster обеспечит трансляцию на YouTube.

ПРИМЕЧАНИЕ. Из-за специфики потоковой трансляции часто возникает задержка с передачей изображения. Перед нажатием кнопки «Остановить трансляцию» необходимо убедиться в том, что показ программы на YouTube действительно завершен, потому что в противном случае она будет прекращена раньше времени.

Создание видеоканалов с помощью ATEM Streaming Bridge

ATEM Streaming Bridge позволяет декодировать поступающий с Web Presenter стриминговый поток и выполнять обратное преобразование для вывода видео через интерфейс SDI или HDMI. С помощью этого конвертера изображение можно передавать как по локальной сети, так и в любую точку мира через Интернет.

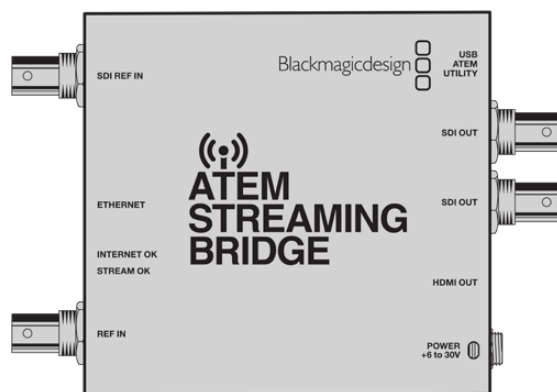

Если конвертер ATEM Streaming Bridge подключен к той же локальной сети, что и Web Presenter, он будет находиться в меню Platform секции Live Stream утилиты Web Presenter Setup.

В противном случае можно загрузить XML-файл с пользовательскими настройками на накопитель USB, подключенный к Web Presenter, или через компьютер с помощью утилиты Web Presenter Setup.

В качестве примера совместного использования устройства Blackmagic Web Presenter и конвертера ATEM Streaming Bridge приведем передачу в студию сведений о погоде из удаленного места. Для этого на локации нужно иметь Web Presenter и доступ к Интернету. К нему можно подключиться через смартфон или по сети.

Находящийся в студии ATEM Streaming Bridge принимает поступающий по Интернету поток и преобразует его в SDI-сигнал для передачи на основной видеомикшер.

В данном случае потребуется выполнить приведенные ниже шаги.

- 1 Находящееся на локации устройство Blackmagic Web Presenter подключить к программному SDI-выходу на видеомикшере, например ATEM Constellation 8K.
- 2 Подключить Blackmagic Web Presenter к смартфону.
- 3 Подсоединить находящийся в студии конвертер ATEM Streaming Bridge к Интернету через Ethernet.
- 4 ATEM Streaming Bridge будет принимать поступающий по Интернету сигнал, преобразовывать и передавать его на SDI-вход студийного видеомикшера для трансляции в программе новостей.

Чтобы находящийся в студии конвертер ATEM Streaming Bridge принимал по Интернету поток от ATEM Web Presenter, следует установить необходимые параметры с помощью утилиты ATEM Setup. Для этого также можно экспортировать XML-файл с настройками стриминга, который легко загрузить на Web Presenter по месту работы.

Создание XML-файла

Чтобы создать XML-файл с настройками, подключите конвертер ATEM Streaming Bridge кабелем к сетевому маршрутизатору или коммутатору через порт Ethernet.

С помощью кабеля USB-C подключите конвертер ATEM Streaming Bridge к компьютеру и запустите утилиту ATEM Setup.

На вкладке Setup подтвердите правильность сетевых настроек и в опциях Stream Service выберите Internet. Если все параметры заданы корректно, в окне состояния будет отображаться сообщение “Visible Worldwide”.

Примечание о переадресации порта

Если в окне состояния интернет-соединения отображается ошибка, связанная с переадресацией порта или UPnP, обратитесь к провайдеру услуг связи или системному администратору, чтобы установить настройку TCP port 1935.

Экспорт XML-файла

После подтверждения настроек на вкладке утилиты ATEM Setup и успешного подключения конвертера ATEM Streaming Bridge к локальной сети или Интернету можно выполнить экспорт XML-файла с конфигурацией параметров.

- 1 Перейдите на вкладку External ATEM Mini Pro сверху справа.

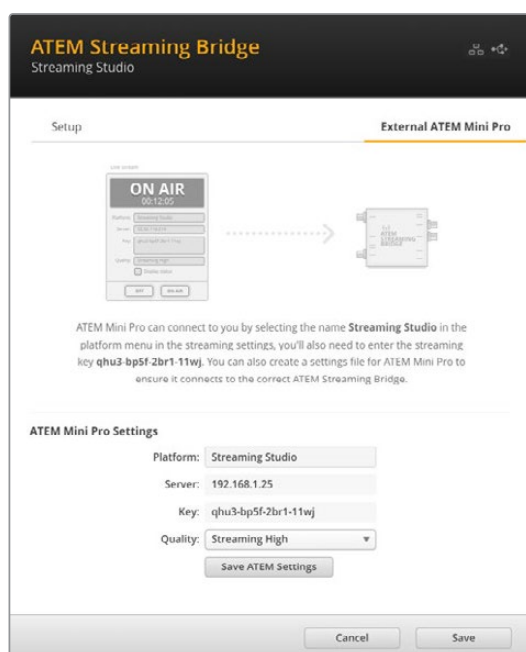

- 2 Чтобы присвоить платформе пользовательское имя, щелкните в поле Platform и введите нужный текст. Это имя будет таким же, как в списке соответствующего меню на удаленном устройстве Blackmagic.
- 3 Выберите нужное качество стриминга. Эта настройка задает соответствующий параметр на удаленном устройстве Web Presenter.
- 4 Нажмите кнопку Save ATEM Settings, выберите расположение на компьютере для сохранения XML-файла и щелкните Save.
- 5 Теперь сохраненный XML-файл можно переслать удаленному оператору по электронной почте.

СОВЕТ. В утилите ATEM Setup можно использовать настройки интерком-связи для выбора аудиоканалов, которые будут передаваться обратно на Web Presenter.

Загрузка XML-файла

XML-файл с настройками стриминга можно получить на локации по электронной почте и загрузить его в Web Presenter с помощью утилиты Blackmagic Web Presenter Setup. После этого для начала трансляции в студию сведений о погоде достаточно нажать кнопку ON AIR.

Следует отметить, что XML-файл с настройками стриминга требуется загрузить всего один раз, после чего трансляцию можно вести многократно. Это значительно облегчает установку постоянного видеоканала между Web Presenter и ATEM Streaming Bridge.

Если на находящемся в студии конвертере ATEM Streaming Bridge не менять настройки сети, стриминга и обнаружения устройства Web Presenter, связь с ним сохранится независимо от его месторасположения. Достаточно просто подключить Web Presenter к Интернету, нажать кнопку ON AIR, и решение сразу же начнет транслировать сигнал на ATEM Streaming Bridge.

Подробнее о применении конвертера ATEM Streaming Bridge см. руководство по ATEM Mini, которое можно загрузить по адресу www.blackmagicdesign.com/ru/support.

Tally-индикация, интерком-связь и управление камерой

ATEM Streaming Bridge и Blackmagic Web Presenter позволяют видеомикшерам ATEM передавать сигналы Tally-индикации, интерком-связи и управления съемочной техникой. Все эти функции будут доступны, если камеру Blackmagic Design с SDI-интерфейсом установить в любом месте локальной сети, а при подключении к Интернету — и в любой точке земного шара.

На рисунке ниже показана схема соединения камеры URSA Mini Pro 4.6K с видеомикшером ATEM Constellation 8K по локальной сети для передачи сигналов Tally-индикации, интерком-связи и управления камерой.

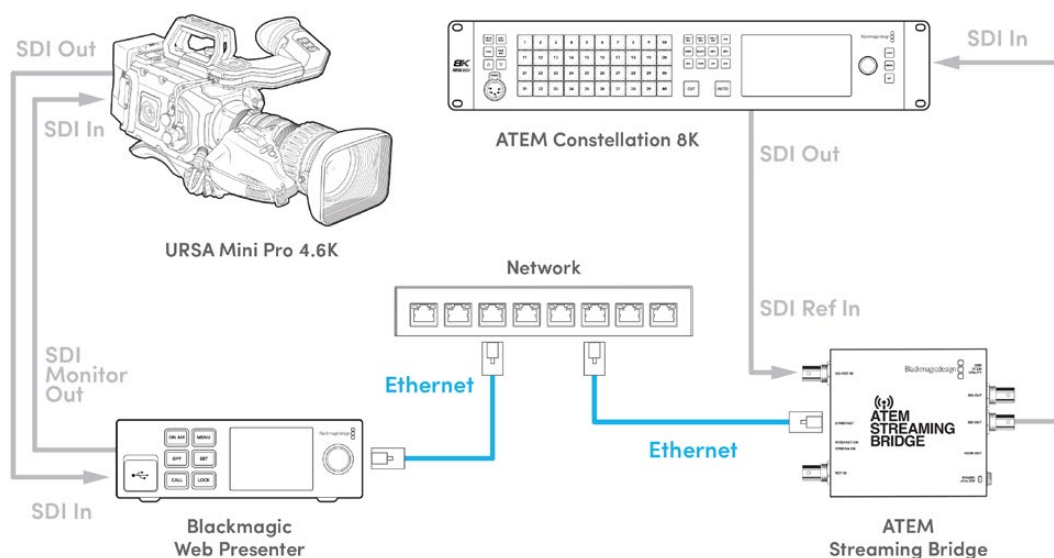

После соединения всех устройств между собой выполните описанные ниже действия.

- 1 Нажмите кнопку MENU на Blackmagic Web Presenter, чтобы открыть меню на ЖК-дисплее, и перейдите к настройкам потоковой трансляции.
- 2 В настройке «Платформа» выберите ATEM Streaming Bridge.
- 3 Нажмите кнопку SET, чтобы подтвердить сделанный выбор.

Чтобы Tally-индикация работала, убедитесь в том, что идентификатор камеры на ATEM соответствует используемому ею входу микшера. Подробнее о настройке этого параметра см. руководство по URSA Mini.

Чтобы проверить работу Tally, переключите камеру для вывода сигнала на программный выход микшера ATEM. Если ее идентификатор на ATEM задан корректно, в это время зажжется соответствующий индикатор, в том числе красная окантовка на ЖК-дисплее камеры. При переходе в режим предварительного просмотра цвет изменится на зеленый.

Чтобы проверить управление параметрами съемки, выполните регулировку диафрагмы и уровня черного на странице «Камера» в приложении ATEM Software Control.

По умолчанию для интерком-связи служат встроенные в SDI-сигнал аудиоканалы 15 и 16, но с помощью утилиты ATEM Setup вместо них можно задать использование инженерных каналов 13 и 14 или программного выхода.

При трансляции по Интернету XML-файл с конфигурацией настроек создается посредством утилиты ATEM Setup. Затем его загружают на Blackmagic Web Presenter, чтобы обнаружить конвертер ATEM Streaming Bridge во всемирной сети. Подробнее о создании и загрузке XML-файла см. предыдущий раздел данного руководства.

Подключение камеры URSA Broadcast G2

URSA Broadcast G2 имеет встроенную платформу стриминга, которая позволяет передавать изображение непосредственно через порт USB-C без использования устройства Blackmagic Web Presenter. Подробнее о порядке работы, включая установку идентификатора камеры на ATEM для корректного функционирования Tally-индикации, см. руководство по URSA Broadcast G2.

Blackmagic Universal Rack Shelf

Для установки оснащения Blackmagic Design в телекоммуникационную стойку или мобильный кейс можно использовать полку Blackmagic Universal Rack Shelf размером 1 RU. Ее модульный дизайн позволяет создавать портативные и практичные конфигурации оборудования на основе решений с подходящим форм-фактором.

На рисунке показаны три полки Universal Rack Shelf, размещенные в небольшой стойке, с установленной комбинацией совместимых между собой устройств. Нижняя из них включает в себя заглушку 1/3 RU для заполнения пустого пространства между модулями.

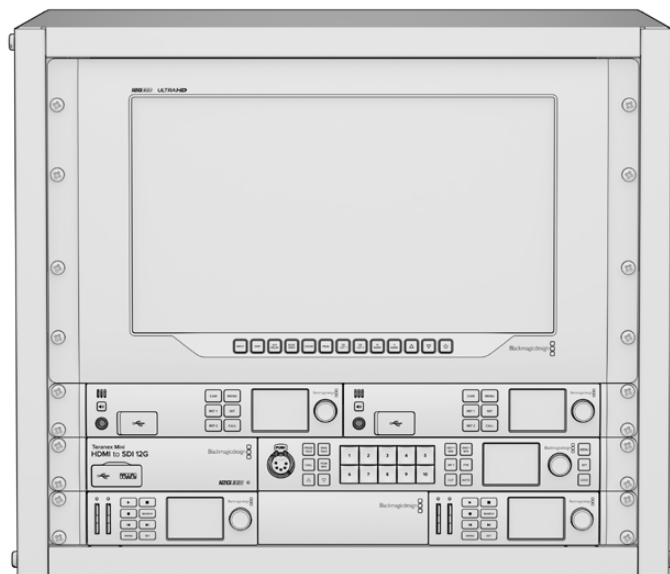

Содержание

Комплект Universal Rack Shelf Kit

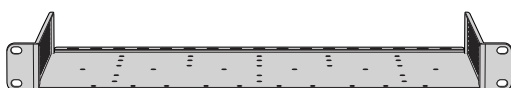

1 x Blackmagic Universal Rack Shelf

Полка шириной 1 RU для установки в стойку оборудования Blackmagic Design

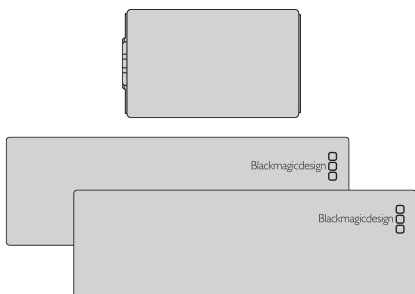

Заглушки

1 x 1/6 RU и 2 x 1/3 RU для заполнения пустого пространства на полке

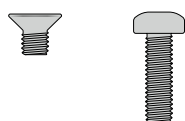

Винты

12 5-мм винтов M3 с утопленной головкой

Два 9-мм плоских винта M3 для заглушки 1/6 RU

Установка устройства на полке Universal Rack Shelf

- 1 Если в основании решения находятся резиновые вставки, снимите их с помощью скребка с пластиковыми краями.
- 2 Перевернув полку и устройство вверх дном, совместите предварительно просверленные отверстия полки с монтажными отверстиями в основании решения Blackmagic Design. На моделях шириной 1/3 RU предусмотрено две центральные точки крепления, а на устройствах 1/2 RU — до трех.

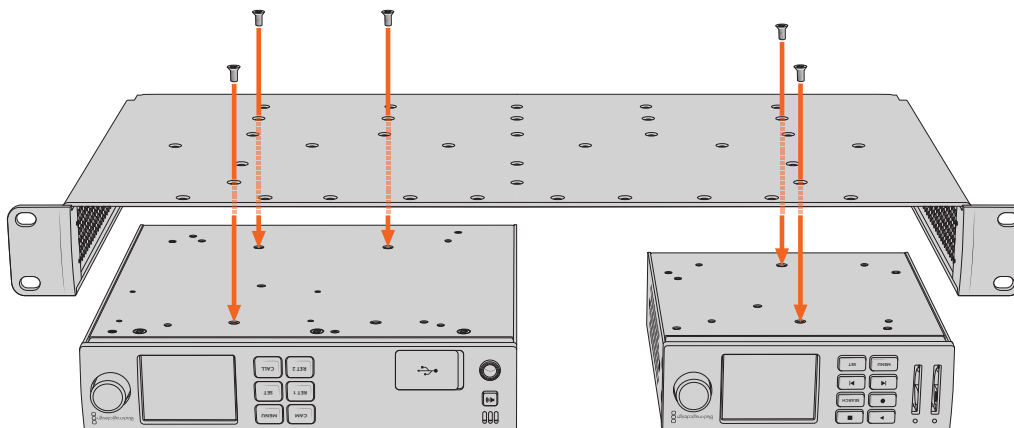

- 3 Используя прилагаемые 5-мм винты М3 с утопленной головкой, закрепите устройство на полке.
- 4 После этого переверните ее правой стороной вверх и установите в стойку с помощью соответствующих скоб.

Заглушки, входящие в комплект поставки, можно использовать для заполнения пустого пространства между модулями.

Порядок установки заглушки 1/6 RU

Небольшая заглушка 1/6 RU предназначена для заполнения пустого пространства при установке в стойке решений шириной 1/2 RU и 1/3 RU. Ее можно закрепить с любой стороны нужного устройства. Для улучшения циркуляции воздуха рекомендуется размещать заглушку между модулями.

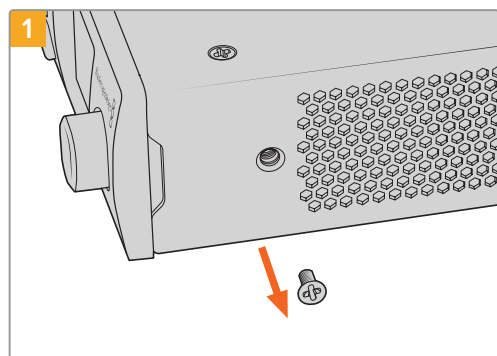

1 Извлеките 5-мм винт М3 сбоку от передней панели устройства

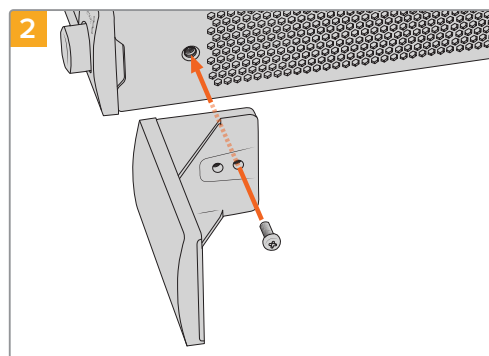

2 Выровняйте заглушку и закрепите ее с помощью прилагаемого 9-мм винта М3

Порядок установки боковой заглушки 1/3 RU

Большие заглушки шириной 1/3 RU можно установить с любой стороны полки при монтаже отдельных устройств. Для этого совместите отверстия под винты и точку крепления в основании заглушки с полкой, а затем закрепите конструкцию с помощью двух прилагаемых 5-мм винтов М3 с утопленной головкой.

Обновление встроенного программного обеспечения

Обновить встроенное ПО устройства Web Presenter, а также изменить настройки трансляции, сетевые параметры и качество записи можно с помощью утилиты Web Presenter Setup.

Порядок обновления встроенного ПО

- 1 Загрузите последнюю версию Blackmagic Web Presenter в разделе поддержки по адресу www.blackmagicdesign.com/ru/support.
- 2 Запустите установщик Blackmagic Web Presenter и следуйте инструкциям на экране.
- 3 После установки подключите Web Presenter к компьютеру через порт USB на задней или передней панели устройства. Для доступа к последнему откройте пластиковую защитную крышку.
- 4 Запустите Blackmagic Web Presenter Setup и следуйте инструкциям на экране. Если они не появляются, используемая версия является актуальной.

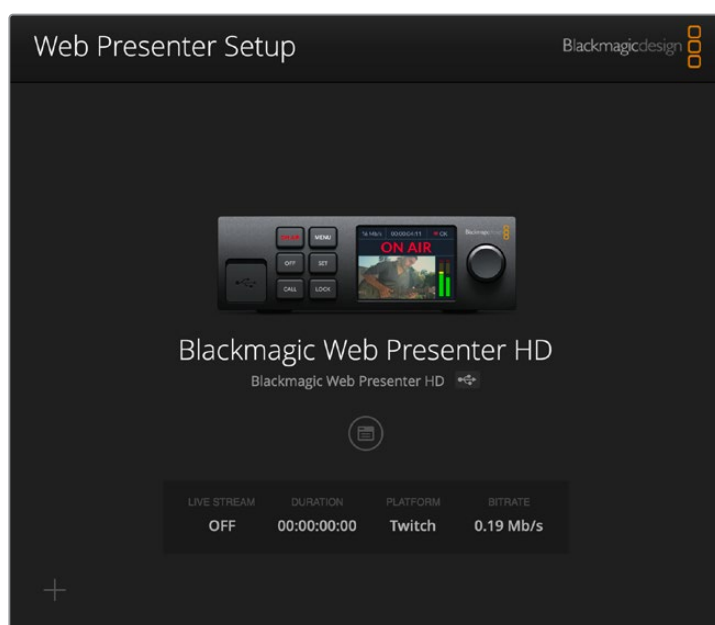

Последнюю версию утилиты Blackmagic Web Presenter можно найти в разделе поддержки на нашем веб-сайте по адресу www.blackmagicdesign.com/ru/support.

Developer Information

Blackmagic Web Presenter Ethernet Protocol

v1.2

Protocol Details

Overview

The Blackmagic Web Presenter Ethernet Protocol is a line-oriented, text-based protocol to control a Web Presenter.

Lines from the Web Presenter server will be separated by an ASCII LF sequence.

Messages from the user may be separated by LF or CR LF.

Connection

The Web Presenter server is accessed by connecting to TCP port 9977 on a Web Presenter.

Connection Response

Upon connection, the Web Presenter server sends a dump of the device's state.

The Web Presenter server sends information in blocks, with each having an identifying header followed by a colon. A block spans multiple lines and is terminated by a blank line. Each line in the protocol is terminated by a newline character.

Following the header, a block contains either a single multi-line string or a sequence of key/value pairs arranged one per line. The first full-colon on a line is used to delimit the key and the value. A value may be a comma separated list. In this case, values in the list must have the “,” and “\” characters escaped with a “\” character.

To be resilient to future protocol changes, clients should ignore blocks they do not recognize, up to the trailing blank line. Within recognized blocks, clients should ignore keys they do not recognize.

Legend	
↵	End of line
...	and so on
Orange Text	Client Generated
Grey Text	Server Generated

The protocol preamble block is always the first block sent by the Web Presenter server:

```
PROTOCOL PREAMBLE:↵
Version: 1.2↵
↵
```

The version field indicates the protocol version. When the protocol is changed in a compatible way, the minor version number will be updated. If incompatible changes are made, the major version number will be updated.

The initial status dump is concluded by the end prelude block:

```
END PRELUDE:↵
↵
```

Status Updates

When any device parameter is changed on the Web Presenter server by any client, such as the Blackmagic Web Presenter Setup utility, the Web Presenter server resends the applicable status block, containing only the items that have changed. Status updates can also occur due to external changes such as tethering to a smartphone or when a streaming service is disconnected.

For example, if the input video mode is set to Auto, the following block will be sent:

```
STREAM SETTINGS:↵  
Video Mode: Auto↵  
↵
```

Requesting Changes

To change one or more parameters in a block, the client should send the appropriate block header in the same form the Web Presenter server sends, followed by the key/value pairs to be changed. For example, to change the input video format to 1080p59.94, the user should send the following block:

```
STREAM SETTINGS:↵  
Video Mode: 1080p59.94↵  
↵
```

The block must be terminated by a blank line. On receipt of a blank line, the Web Presenter server will either acknowledge the request by responding:

```
ACK↵  
↵
```

or if unable to parse the block responding with:

```
NACK↵  
↵
```

After a positive response, the client should expect to see a status update from the Web Presenter server showing the status change. This is likely to be the same as the command that was sent, sometimes followed by other blocks providing data specific to the change.

```
STREAM SETTINGS:↵  
Video Mode: 1080p59.94↵  
↵
```

If the Web Presenter server does not understand a key in the requested block, the key will be ignored. If an invalid value is provided for a known key, then the request is ignored and the Web Presenter will respond with the existing value for the key. In both cases the Web Presenter server will still respond with an ACK.

```
STREAM SETTINGS:↵  
Video Mode: UnsupportedMode↵  
↵  
ACK↵  
↵  
STREAM SETTINGS:↵  
Video Mode: 1080p59.94↵  
↵
```

Requesting a Status Dump

The user may request that the Web Presenter server resend the complete state of any status block by sending the block header, followed by a blank line. In the following example, the user requests the Web Presenter server resend the stream settings:

```
STREAM SETTINGS:↵
↵
ACK↵
↵
STREAM SETTINGS:↵
Video Mode: 1080p59.94↵
...
↵
```

Protocol Blocks

Identity Block

The identity block contains information to identify the connected Web Presenter.

Block Syntax

The following example shows the Identity Block for a Blackmagic Web Presenter HD.

```
IDENTITY:↵
Model: Blackmagic Web Presenter HD↵
Label: Blackmagic Web Presenter HD↵
Unique ID: 00112233445566778899AABBCCDDEEFF↵
↵
```

Parameters

Key	Read/Write	Description	Valid Values
Model	Read only	The Web Presenter model name	String
Label	Read/Write	A display name for the Web Presenter	String
Unique ID	Read only	A device specific unique identifier	Hexadecimal ID

Changing Device Label

A device label to identify the Web Presenter can be changed by sending an identity block with label key.

```
IDENTITY:↵
Label: My Web Presenter↵
↵
ACK↵
↵
IDENTITY:↵
Label: My Web Presenter↵
↵
```

Version Block

The version block contains hardware and software version information for the connected Web Presenter.

Block Syntax

```
VERSION:↵  
Product ID: BE73↵  
Hardware Version: 0100↵  
Software Version: 0123ABCD↵  
Software Release: 3.3↵  
↵
```

Parameters

Key	Read/Write	Description	Valid Values
Product ID	Read only	The Web Presenter product ID	Hexadecimal ID
Hardware Version	Read only	The Web Presenter hardware version	Hexadecimal version
Software Version	Read only	The Web Presenter software version	Hexadecimal version
Software Release	Read only	The Web Presenter software release version	Version Number

Network Blocks

The network block contains the TCP/IP networking configuration for the connected Web Presenter.

Block Syntax

This example shows the output for a connected Web Presenter. It displays 2 networking interfaces - the Gigabit Ethernet interface and option for a tethered smartphone.

The network settings prefixed with Current show the active TCP/IP settings, and are read-only. The Current settings reflect either the DHCP or Static configuration, depending on the Dynamic IP flag.

```
NETWORK:↵  
Interface Count: 2↵  
Default Interface: 0↵  
↵  
NETWORK INTERFACE 0:↵  
Name: Ethernet↵  
Priority: 1↵  
MAC Address: 00:11:22:33:44:55↵  
Dynamic IP: true↵  
Current Addresses: 192.168.1.10/255.255.255.0↵  
Current Gateway: 192.168.1.1↵  
Current DNS Servers: 192.168.1.1, 8.8.8.8, 8.8.4.4↵  
Static Addresses: 10.0.0.2/255.255.255.0↵  
Static Gateway: 10.0.0.1↵  
Static DNS Servers: 8.8.8.8, 8.8.4.4↵  
↵
```

```

NETWORK INTERFACE 1:↵
Name: USBEthernet↵
Priority: 0↵
MAC Address: 00:00:00:00:00:00↵
Dynamic IP: true↵
Current Addresses: 0.0.0.0/255.255.0.0↵
Current Gateway: 0.0.0.0↵
Current DNS Servers: ↵
Static Addresses: 10.0.0.2/255.255.255.0↵
Static Gateway: 10.0.0.1↵
Static DNS Servers: 8.8.8.8, 8.8.4.4↵
↵

```

Parameters

Network Block

Key	Read/Write	Description	Valid Values
Interface Count	Read only	The number of networking interfaces supported by the Web Presenter	Integer
Default Interface	Read only	The default networking interface	Integer

Network Interface Block

Key	Read/Write	Description	Valid Values
Name	Read only	The name of the networking interface	String
Priority	Read/Write	The priority of the network interface. When multiple network interfaces are available, the high priority interface will become the default	Unsigned integer. The higher number is the higher priority
MAC Address	Read Only	MAC address of the networking interface	IEEE 802 MAC address
Dynamic IP	Read/Write	Selects DHCP or Static IP configuration	true - DHCP enabled false - Static IP
Current Addresses	Read Only	The current IP address and Subnet mask	{IPv4 address}/{Subnet Mask}
Current Gateway	Read Only	The current IP gateway address	IPv4 address
Current DNS Servers	Read only	The IP addresses of the current DNS servers	Comma separated list of IPv4 addresses
Static Addresses	Read/Write	Status IP address and subnet mask when DHCP disabled	{IPv4 address}/{Subnet Mask}
Static Gateway	Read/Write	Static gateway address when DHCP disabled	IPv4 address
Static DNS Servers	Read/Write	The IP addresses of the static DNS servers	Comma separated list of IPv4 addresses

Changing Networking Settings

The network can be configured to use either DHCP or a static configuration. To enable DHCP on Network Interface 0:

```
NETWORK INTERFACE 0:↵  
Dynamic IP: true↵  
↵  
ACK↵  
↵  
NETWORK INTERFACE 0:↵  
Dynamic IP: true↵  
↵
```

To set a fixed IP address, supply all static parameters:

```
NETWORK INTERFACE 0:↵  
Dynamic IP: false↵  
Static Addresses: 192.168.1.2/255.255.255.0↵  
Static Gateway: 192.168.1.1↵  
Static DNS Servers: 8.8.8.8, 8.8.4.4↵  
↵  
ACK↵  
↵  
NETWORK INTERFACE 0:↵  
Dynamic IP: false↵  
Static Addresses: 192.168.1.2/255.255.255.0↵  
Static Gateway: 192.168.1.1↵  
Static DNS Servers: 8.8.8.8, 8.8.4.4↵  
↵
```

Changing network settings may cause the IP connection to be dropped.

UI Settings Block

The UI settings block contains the front panel LCD and monitor output settings for the connected Web Presenter.

Block Syntax

```
UI SETTINGS:↵  
Available Locales: en_US.UTF-8, zh_CN.UTF-8, ja_JP.UTF-8, ko_KR.UTF-8, es_↵  
ES.UTF-8, de_DE.UTF-8, fr_FR.UTF-8, ru_RU.UTF-8, it_IT.UTF-8, pt_BR.UTF-8,↵  
tr_TR.UTF-8, pl_PL.UTF-8, uk_UA.UTF-8↵  
Current Locale: en_US.UTF-8↵  
Available Audio Meters: PPM -18dB, PPM -20dB, VU -18dB, VU -20dB↵  
Current Audio Meter: PPM -20dB↵  
↵
```

Parameters

Key	Read/Write	Description	Valid Values
Available Locales	Read only	The locales available in the Web Presenter	Comma separated list of locales
Current Locale	Read/Write	The current locale for Web Presenter	Refer to the locales from the Available Locales field
Available Audio Meters	Read only	The available audio meters supported by the Web Presenter	Comma separated list of audio meter types
Current Audio Meter	Read/Write	The current audio meter	Refer to the audio meters from the Available Audio Meters field

Stream Settings Block

The stream settings block contains the stream configuration for the connected Web Presenter.

Block syntax

This example shows the output for a connected Web Presenter. The stream settings prefixed with Current show the active stream settings and are writable. The stream settings prefixed by Available show the available stream settings for the device or platform and are read-only. To view the available servers or quality levels for a stream service, the Current Platform stream setting should be set first.

```
STREAM SETTINGS:↵
Available Video Modes: Auto, 1080p23.98, 1080p24, 1080p25, 1080p29.97,
1080p30, 1080p50, 1080p59.94, 1080p60, 720p25, 720p30, 720p50, 720p60↵
Video Mode: 1080p59.94↵
Current Platform: YouTube↵
Current Server: Primary↵
Current Quality Level: Streaming Medium↵
Stream Key: abc1-def2-ghi3-jkl4-mno5↵
Password: ↵
Current URL: srt://192.168.8.51
Customizable URL: true
Available Default Platforms: YouTube RTMP, YouTube SRT (Beta), Facebook,
Twitch, Twitter, Restream.IO, Vimeo, BoxCast, CastR, AfreecaTV, Bilibili,
DouYu, Weibo↵
Available Custom Platforms: My Platform↵
Available Servers: Primary, Secondary↵
Available Quality Levels: HyperDeck High, HyperDeck Medium, HyperDeck Low,
Streaming High, Streaming Medium, Streaming Low↵
↵
```

Parameters

Key	Read/Write	Description	Valid Values
Available Video Modes	Read only	The video modes available in the Web Presenter	Comma separated list of video modes
Video Mode	Read/Write	The current video mode	Refer to the video modes from the <i>Available Video Modes</i> field
Current Platform	Read/Write	The selected streaming platform	Refer to the platforms from the <i>Available Default Platforms</i> and <i>Available Custom Platforms</i> fields
Current Server	Read/Write	The current server for the streaming platform	Server is dependent on selected Current Platform
Current Quality Level	Read/Write	The current streaming quality level	Quality level is dependent on selected Current Platform
Stream Key	Read/Write	The stream key for the streaming platform	String
Password	Read/Write	The passphrase for an encrypted SRT stream	String
Current URL	Read/Write	The current URL for the streaming platform. This field is writable if <i>Customizable URL</i> field is true.	String
Customizable URL	Read only	A boolean specifying whether custom URLs are supported by the streaming platform	true - Custom URLs are supported false - Custom URLs are not supported
Available Default Platforms	Read only	The available default streaming platforms	Comma separated list of default platforms
Available Custom Platforms	Read only	The custom streaming platforms loaded in the Web Presenter	Comma separated list of custom platforms
Available Servers	Read only	The available servers for the selected streaming platform	Comma separated list of servers
Available Quality Levels	Read only	The available quality levels for the selected streaming platform	Comma separated list of quality levels

Changing Stream Settings

The stream settings can be changed by providing a stream settings block. The following is an example of streaming a 1080p59.94 input on Twitch with a medium stream quality.

```

STREAM SETTINGS:↵
Video Mode: 1080p59.94↵
Current Platform: Twitch↵
Current Server: US West: Los Angeles, CA↵
Current Quality Level: Streaming Medium↵
Stream Key: live_123456789_1aB2cD3eF4gH5iJ6kL7mN8oP9qR0sT↵
↵
ACK↵
↵
STREAM SETTINGS:↵
Video Mode: 1080p59.94↵
Current Platform: Twitch↵
Current Server: US West: Los Angeles, CA↵
Current Quality Level: Streaming Medium↵
Stream Key: live_123456789_1aB2cD3eF4gH5iJ6kL7mN8oP9qR0sT↵
↵

```

Stream XML Block

The stream XML block allows users to configure the Web Presenter with a custom configuration file in XML format.

Block syntax

The following example shows an XML file - Custom.xml has been loaded to configure the stream settings in the Web Presenter.

```
STREAM XML:↵  
Files: Custom.xml↵  
↵
```

Parameters

Key	Read/Write	Description	Valid Values
Files	Read/Write	The XML files loaded in Web Presenter	Comma separated list of filenames
Action	Write only	The stream XML action	Remove Remove All

Adding a Stream XML file

An XML file can be loaded onto a Web Presenter by sending the stream xml command with a filename, then provide the contents of the XML file. After adding the XML file, the Available Custom Platforms field in the STREAM SETTINGS block will be updated with the new platforms, however the Current items will remain unchanged.

For the Stream XML block to be parsed correctly, any blank lines should be removed from the XML files.

Refer to the `Blackmagic Stream XML File Format` section in this manual for description of the Stream XML file format.

```
STREAM XML Custom.xml:↵  
<?xml version="1.0" encoding="UTF-8"?>↵  
<streaming>↵  
    <service>↵  
        <name>My Custom Platform</name>↵  
        ...  
    </service>↵  
</streaming>↵  
↵  
ACK↵  
↵  
STREAM XML Custom.xml:↵  
<?xml version="1.0" encoding="UTF-8"?>↵  
<streaming>↵  
    <service>↵  
        <name>My Custom Platform</name>↵  
        ...  
    </service>↵  
</streaming>↵  
↵
```

```
STREAM XML:↵
Files: Custom.xml↵
↵
STREAM SETTINGS:↵
Available Custom Platforms: My Custom Platform↵
↵
```

Removing a Stream XML file

An XML file can be removed from the Web Presenter by sending the stream xml command with the remove action.

```
STREAM XML:↵
Action: Remove↵
Files: Custom.xml↵
↵
ACK↵
↵
STREAM XML:↵
Files:↵
↵
STREAM SETTINGS:↵
Available Custom Platforms:↵
↵
```

Removing all Stream XML files

All XML files can be removed from the Web Presenter by sending the stream xml command with the remove all action. In the example, following the remove all action, the loaded stream XML files and available custom platforms are both displayed as empty.

```
STREAM XML:↵
Action: Remove All↵
↵
ACK↵
↵
STREAM XML:↵
Files: ↵
↵
STREAM SETTINGS:↵
Available Custom Platforms:↵
↵
```

Stream State Block

The stream state block provides the streaming status of the Web Presenter.

The Web Presenter server will send a stream state block update whenever there is a change to the Status field. Due to frequency of changes to Duration, Bitrate and Cache Used fields, these fields need to be polled by the client by requesting a Stream State block.

Block syntax

```
STREAM STATE:↵↵
Status: Idle↵↵
Bitrate: 161672↵↵
Duration: 00:00:00:00↵↵
Cache Used: 0↵↵
↵↵
```

Parameters

Key	Read/Write	Description	Valid Values
Status	Read only	The stream state of the Web Presenter, updated when the stream status changes	Idle Connecting Streaming Interrupted
Action	Write only	The Web Presenter stream state action.	Start Stop
Duration	Read only	The duration of the active stream	String in format of DD:HH:MM:SS
Bitrate	Read only	The bitrate of the active stream	Integer bits per second
Cache Used	Read only	The current usage of the streaming cache	Integer as a percentage

Starting Stream

The stream is started by providing a stream state block with start action.

```
STREAM STATE:↵↵
Action: Start↵↵
↵↵
ACK↵↵
↵↵
STREAM STATE:↵↵
Status: Connecting↵↵
↵↵
STREAM STATE:↵↵
Status: Streaming↵↵
↵↵
```

Stopping stream

The stream is stopped by providing a Stream State block with stop action.

```
STREAM STATE:↵↵
Action: Stop↵
↵
ACK↵
↵
STREAM STATE:↵↵
Status: Idle↵
↵
```

Audio Settings Block

The Audio Settings block contains the audio configuration for the connected Web Presenter.

Block syntax

This example shows the output for a connected Web Presenter. The stream settings prefixed with Current show the active audio settings and are writable. The stream settings prefixed by Available show the available audio settings for the device or platform and are read-only.

```
AUDIO SETTINGS:↵↵
Current Monitor Out Audio Source: Auto↵
Available Monitor Out Audio Sources: Auto, SDI In, Remote Source↵
↵
```

Parameters

Key	Read/Write	Description	Valid Values
Current Monitor Out Audio Source	Read/Write	The current audio source on the monitor output	Refer to the audio sources from the <i>Available Monitor Out Audio Sources</i> field
Available Monitor Out Audio Sources	Read only	The available audio sources that can be routed to the monitor output	Comma separated list of audio sources

Changing Audio Settings

The audio settings can be changed by providing an audio settings block. The following is an example of setting the monitor output audio source to remote.

```
AUDIO SETTINGS:↵↵
Current Monitor Out Audio Source: Remote Source↵
↵
ACK↵
↵
AUDIO SETTINGS:↵↵
Current Monitor Out Audio Source: Remote Source↵
↵
```

Shutdown Block

The Shutdown block provides power control of the Web Presenter. The Shutdown block is write-only and not presented in the preamble.

Parameters

Key	Read/Write	Description	Valid Values
Action	Write only	The Web Presenter shutdown action.	Reboot Factory Reset

Reboot

The Web Presenter can be rebooted by providing a Shutdown block with reboot action.

```
SHUTDOWN:↵
```

```
Action: Reboot↵
```

```
↵
```

```
ACK↵
```

```
↵
```

On reboot action, the Web Presenter server will be stopped and clients will be disconnected.

Factory Reset

The Web Presenter can be factory reset by providing a Shutdown block with factory reset action. On factory reset action, all settings are set to factory defaults.

```
SHUTDOWN:↵
```

```
Action: Factory Reset↵
```

```
↵
```

```
ACK↵
```

```
↵
```

Blackmagic Streaming XML Format

Overview

The Blackmagic Streaming XML allows users to specify streaming services in addition to the default services provided by the Web Presenter.

The Streaming XML can be loaded into the Web Presenter with Web Presenter Setup. Refer to the 'Using Web Presenter Setup' section earlier in this manual

The Streaming XML can also be loaded by copying the contents into the Stream XML block with the Blackmagic Web Presenter Ethernet Protocol.

The following is a minimal example of a Streaming XML file:

```
<?xml version="1.0" encoding="UTF-8"?>
<streaming>
  <service>
    <name>My Streaming Service</name>
    <servers>
      <server>
        <name>My Streaming Server</name>
        <url>rtmp://my.streaming-server.com/live</url>
      </server>
    </servers>
    <profiles>
      <profile>
        <name>My Streaming Quality</name>
        <config resolution="1080p" fps="60" codec="H264">
          <bitrate>7500000</bitrate>
        </config>
      </profile>
    </profiles>
  </service>
</streaming>
```

Streaming XML Definition

The Streaming XML file follows standard XML format and shall begin with XML declaration.

```
<?xml version="1.0" encoding="UTF-8"?>
```

Streaming Element

The Streaming XML file shall be contained by the <streaming> element. The <streaming> element will consist of 1 or more <service> child elements.

The following is an example of a <streaming> element block that defines 2 streaming services.

```
<streaming>
  <service>
    <name>Service 1</name>
    <!-- Streaming settings for "Service 1" -->
  </service>
  <service>
    <name>Service 2</name>
    <!-- Streaming settings for "Service 2" -->
  </service>
</streaming>
```

Service Element

The <service> element provides a description of the streaming service. If multiple streaming services are used, it is possible to define multiple <service> elements within each <streaming> element block.

The following is an example of a <service> element block in the Stream XML file.

```
<streaming>
  <service customizable-url="true">
    <name>My Streaming Service</name>
    <key>abc1-def2-ghi3-jkl4-mno5</key>
    <servers>
      <!-- Streaming server settings -->
    </servers>
    <profiles default="Streaming High">
      <!-- Streaming quality settings-->
    </profiles>
    <credentials>
      <!-- Streaming username and password settings -->
    </credentials>
  </service>
  <!-- <service> elements blocks for other streaming services -->
</streaming>
```

Attributes

Attribute	Optional/Required	Description
customizable-url	Optional	The service supports specifying custom URLs - supported = "true" or unsupported = "false" (default)

Child Elements

Element	Optional/Required	Description
<name>	Required	The name of the streaming service
<key>	Optional	The stream key for the streaming service
<servers>	Optional	The RTMP/SRT server settings of the streaming service (see below). May be omitted if customizable-url is true.
<profiles>	Required	The quality settings of the streaming service (see below)
<credentials>	Optional	The username and password of the streaming service (see below)

Servers Element

The <servers> element consists of 1 or more <server> child elements for defining the streaming server(s). The <servers> element is a required child of the <service> element. Defining multiple servers allows specifying localized and/or backup servers within a single XML description

The following is an example of a <servers> element block that defines a primary and secondary URL for the SRT server.

```
<service>
  ...
  <servers>
    <server group="Primary">
      <name>My Streaming Service Server</name>
      <url>srt://srt.my-streaming-service.com:2010</url>
      <srt-extensions>
        ...
      </srt-extensions>
    </server>
    <server group="Secondary">
      <name>My Streaming Service Backup Server</name>
      <url>srt://srt-backup.my-streaming-service.com:2010</url>
      <srt-extensions>
        ...
      </srt-extensions>
    </server>
    <!-- Additional <server> element blocks defining other
servers for streaming service -->
  </servers>
  ...
</service>
```

Attributes

Attribute	Optional/Required	Description
group	Optional	The logical grouping for the server

Child Elements

Element	Optional/Required	Description
<name>	Required	The name of the RTMP/SRT streaming server
<url>	Required	The URL of the RTMP/SRT streaming server
<srt-extensions>	Optional	Extended service block specific to SRT streaming server (see below)

SRT Extensions Element

The <srt-extensions> element consists of 1 or more child elements that define SRT specific parameters.

The following is an example of a <srt-extensions> element block for a primary stream identifier.

```
<service>
  ...
  <servers>
    <server group="Primary">
      ...
      <srt-extensions>
        <stream-id>
          <item key="copy" value="0"/>
        </stream-id>
      </srt-extensions>
    </server>
  </servers>
  ...
</service>
```

Child Elements

Element	Optional/Required	Description
<stream-id>	Required	Provides element with custom parameters for the stream ID. Each child element of stream-id has 1 or more item elements with a key/value pair.

Profiles Element

The <profiles> element consists of 1 or more <profile> child elements that define streaming quality. The <profiles> element is a required child of the <service> element. Defining multiple profiles allows specifying custom bitrates for different streaming qualities.

The following is an example of a <profiles> element block that defines 3 profiles.

```
<service>
  ...
  <profiles default="Streaming High">
    <profile>
      <name>Streaming High</name>
      <!-- Define <config> elements to specify target
bitrates for Streaming High profile -->
    </profile>
    <profile>
      <name>Streaming Medium</name>
      <!-- Define <config> elements to specify target
bitrates for Streaming Medium profile -->
    </profile>
  </profiles>
  ...
</service>
```

Attributes

Attribute	Optional/Required	Description
default	Optional	The name of the default profile

Child Elements

Element	Optional/Required	Description
<name>	Required	The name of the profile
<config>	Required	Video mode dependent quality settings for profile (see below)

Config Element

The <config> element defines a mapping between the video resolution and frame rate and the target bitrate for the quality level. The <config> element is a child of the <profile> element.

The following is an example of a <config> element block for setting the target bitrate for a high quality stream with 720p60 and 1080p60 video inputs.

```
<profile>
  <name>Streaming High</name>
  <config resolution="720p" fps="60" codec="H264">
    <bitrate>6000000</bitrate>
    <audio-bitrate>128000</audio-bitrate>
  </config>
  <config resolution="1080p" fps="60" codec="H264">
    <bitrate>8000000</bitrate>
    <audio-bitrate>128000</audio-bitrate>
  </config>
  <!-- <config> elements for other resolutions and frame rates -->
</profile>
```

Attributes

Attribute	Optional/Required	Description
resolution	Required	The resolution of the streaming video mode
fps	Required	The frame rate of the streaming video mode (frames per second)
codec	Optional	The codec for encoding the streaming video - "H264" (default) or "H265"

Child Elements

Element	Optional/Required	Description
<bitrate>	Required	The target bitrate of the streaming video (bits per second)
<audio-bitrate>	Optional	The target bitrate of the streaming audio (bits per second)

The supported streaming quality bitrates can be found in section `Using Web Presenter Setup` section earlier in this manual.

TIP For each <config> element block, choose a maximum resolution and fps to cover all video modes for the target bitrate. For example, defining a <config> element with resolution="1080p" and fps = "30" will apply for video modes 1080p23.98, 1080p24, 1080p25, 1080p29.97 and 1080p30.

For audio bitrate, only 128 Kb/s is supported.

Credentials Element

The <credentials> element allows specifying an RTMP session username and password if required by the service. The <credentials> element is an optional child to service element.

The following is an example of a <credentials> element block that defines a username and password for the streaming service.

```
<service>
  ...
  <credentials>
    <username>myusername</username>
    <password>abcd1234</password>
  </credentials>
  ...
</service>
```

Child Elements

Element	Optional/Required	Description
<username>	Required	RTMP session username
<password>	Required	RTMP/SRT session password

Помощь

Как получить помощь

Самый быстрый способ получить помощь — обратиться к страницам поддержки на сайте Blackmagic Design и проверить наличие последних справочных материалов по Blackmagic Web Presenter.

Раздел поддержки на сайте Blackmagic Design

Последнюю версию руководства можно найти в разделе поддержки Blackmagic Design на странице www.blackmagicdesign.com/ru/support.

Форум сообщества Blackmagic Design

Посетите форум сообщества Blackmagic Design на нашем веб-сайте, чтобы получить дополнительную информацию и узнать об интересных творческих идеях. На нем можно поделиться своими идеями, а также получить помощь от персонала поддержки и других пользователей. Адрес форума <https://forum.blackmagicdesign.com>.

Обращение в Службу поддержки Blackmagic Design

Если с помощью доступных справочных материалов и форума решить проблему не удалось, воспользуйтесь формой «Отправить нам сообщение» на странице поддержки. Можно также позвонить в ближайшее представительство Blackmagic Design, телефон которого вы найдете в разделе поддержки на нашем веб-сайте.

Соблюдение нормативных требований



Утилизация электрооборудования и электронной аппаратуры в Европейском Союзе

Изделие содержит маркировку, в соответствии с которой его запрещается утилизировать вместе с бытовыми отходами. непригодное для эксплуатации оборудование необходимо передать в пункт вторичной переработки. Раздельный сбор отходов и их повторное использование позволяют беречь природные ресурсы, охранять окружающую среду и защищать здоровье человека. Чтобы получить подробную информацию о порядке утилизации, обратитесь в местные муниципальные органы или к дилеру, у которого вы приобрели это изделие.



Данное оборудование протестировано по требованиям для цифровых устройств класса А (раздел 15 спецификаций FCC) и признано соответствующим всем предъявляемым критериям. Соблюдение упомянутых нормативов обеспечивает достаточную защиту от вредного излучения при работе оборудования в нежилых помещениях. Так как это изделие генерирует и излучает радиоволны, при неправильной установке оно может становиться источником радиопомех. Если оборудование эксплуатируется в жилых помещениях, высока вероятность возникновения помех, влияние которых в этом случае пользователь должен устранить самостоятельно.

До эксплуатации допускаются устройства, соответствующие двум главным требованиям.

- 1 Оборудование не должно быть источником вредных помех.
- 2 Оборудование должно быть устойчивым к помехам, включая помехи, которые могут вызвать сбой в работе.



R-R-BMD-20201201001
R-R-BMD-20201201002

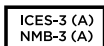

Соответствие требованиям ISED (Канада)

Данное оборудование соответствует канадским стандартам для цифровых устройств класса А.

Любая модификация или использование изделия не по назначению могут повлечь за собой аннулирование заявления о соответствии этим стандартам.

Подключение к HDMI-интерфейсу должно выполняться с помощью качественного экранированного кабеля.

Данное оборудование протестировано по требованиям, предъявляемым к устройствам при работе в нежилых помещениях. При использовании в бытовых условиях оно может становиться источником помех для радиосигнала.

Правила безопасности

Электрическая розетка для подключения этого оборудования к сети должна иметь заземляющий контакт.

Чтобы минимизировать опасность поражения электрическим током, изделие необходимо защищать от попадания брызг и капель воды.

Допускается эксплуатация в условиях тропического климата с температурой окружающей среды до 40° С.

Устройство рекомендуется хранить при температуре от -20° С до 60° С и относительной влажности от 0% до 90% (без конденсации).

Для работы устройства необходимо обеспечить достаточную вентиляцию.

При установке в стойку убедитесь в том, что не нарушен приток воздуха.

Внутри корпуса не содержатся детали, подлежащие обслуживанию. Для выполнения ремонтных работ обратитесь в местный сервисный центр Blackmagic Design.



Допускается эксплуатация в местах не выше 2000 метров над уровнем моря.

Уведомление для жителей штата Калифорния

При работе с этим оборудованием существует возможность контакта с содержащимися в пластмассе микропримесями многобромистого бифенила, который в штате Калифорния признан канцерогеном и увеличивает риск врожденных дефектов и пороков репродуктивной системы.

Подробнее см. информацию на сайте www.P65Warnings.ca.gov.

Гарантия

Ограниченная гарантия сроком 3 года

Компания Blackmagic Design гарантирует отсутствие в устройствах Web Presenter дефектов материала и производственного брака в течение 36 месяцев с даты продажи. Для разъемов, кабелей, охлаждающих вентиляторов, оптоволоконных модулей, предохранителей, клавиатуры и аккумуляторных батарей гарантия отсутствия дефектов материала и производственного брака составляет 12 месяцев с даты продажи. Если во время гарантийного срока будут выявлены дефекты, Blackmagic Design по своему усмотрению выполнит ремонт неисправного изделия без оплаты стоимости запчастей и трудозатрат или заменит такое изделие новым.

Чтобы воспользоваться настоящей гарантией, потребитель обязан уведомить компанию Blackmagic Design о дефекте до окончания гарантийного срока и обеспечить условия для предоставления необходимых услуг. Потребитель несет ответственность за упаковку и доставку неисправного изделия в соответствующий сервисный центр Blackmagic Design с оплатой почтовых расходов. Потребитель обязан оплатить все расходы по доставке и страхованию, пошлины, налоги и иные сборы в связи с возвратом изделия вне зависимости от причины возврата.

Настоящая гарантия не распространяется на дефекты, отказы и повреждения, возникшие из-за ненадлежащего использования, неправильного ухода или обслуживания. Компания Blackmagic Design не обязана предоставлять услуги по настоящей гарантии: а) для устранения повреждений, возникших в результате действий по установке, ремонту или обслуживанию изделия лицами, которые не являются персоналом Blackmagic Design; б) для устранения повреждений, возникших в результате ненадлежащего использования или подключения к несовместимому оборудованию; в) для устранения повреждений или дефектов, вызванных использованием запчастей или материалов других производителей; г) если изделие было модифицировано или интегрировано с другим оборудованием, когда такая модификация или интеграция увеличивает время или повышает сложность обслуживания изделия. НАСТОЯЩАЯ ГАРАНТИЯ ПРЕДОСТАВЛЯЕТСЯ КОМПАНИЕЙ BLACKMAGIC DESIGN ВМЕСТО ЛЮБЫХ ДРУГИХ ПРЯМО ВЫРАЖЕННЫХ ИЛИ ПОДРАЗУМЕВАЕМЫХ ГАРАНТИЙ. КОМПАНИЯ BLACKMAGIC DESIGN И ЕЕ ДИЛЕРЫ ОТКАЗЫВАЮТСЯ ОТ ЛЮБЫХ ПОДРАЗУМЕВАЕМЫХ ГАРАНТИЙ КОММЕРЧЕСКОЙ ЦЕННОСТИ ИЛИ ПРИГОДНОСТИ ДЛЯ КАКОЙ-ЛИБО ОПРЕДЕЛЕННОЙ ЦЕЛИ. ОТВЕТСТВЕННОСТЬ BLACKMAGIC DESIGN ПО РЕМОНТУ ИЛИ ЗАМЕНЕ НЕИСПРАВНЫХ ИЗДЕЛИЙ ЯВЛЯЕТСЯ ПОЛНЫМ И ИСКЛЮЧИТЕЛЬНЫМ СРЕДСТВОМ ВОЗМЕЩЕНИЯ, ПРЕДОСТАВЛЯЕМЫМ ПОТРЕБИТЕЛЮ В СВЯЗИ С КОСВЕННЫМИ, ФАКТИЧЕСКИМИ, СОПУТСТВУЮЩИМИ ИЛИ ПОСЛЕДУЮЩИМИ УБЫТКАМИ, ВНЕ ЗАВИСИМОСТИ ОТ ТОГО, БЫЛА ИЛИ НЕТ КОМПАНИЯ BLACKMAGIC DESIGN (ЛИБО ЕЕ ДИЛЕР) ПРЕДВАРИТЕЛЬНО ИЗВЕЩЕНА О ВОЗМОЖНОСТИ ТАКИХ УБЫТКОВ. BLACKMAGIC DESIGN НЕ НЕСЕТ ОТВЕТСТВЕННОСТИ ЗА ПРОТИВОПРАВНОЕ ИСПОЛЬЗОВАНИЕ ОБОРУДОВАНИЯ СО СТОРОНЫ ПОТРЕБИТЕЛЯ. BLACKMAGIC DESIGN НЕ НЕСЕТ ОТВЕТСТВЕННОСТИ ЗА УБЫТКИ, ВОЗНИКАЮЩИЕ ВСЛЕДСТВИЕ ИСПОЛЬЗОВАНИЯ ЭТОГО ИЗДЕЛИЯ. РИСКИ, СВЯЗАННЫЕ С ЕГО ЭКСПЛУАТАЦИЕЙ, ВОЗЛАГАЮТСЯ НА ПОТРЕБИТЕЛЯ.

© Copyright 2023 Blackmagic Design. Все права защищены. Blackmagic Design, DeckLink, HDLink, Workgroup Videohub, Multibrige Pro, Multibrige Extreme, Intensity и "Leading the creative video revolution" зарегистрированы как товарные знаки в США и других странах. Названия других компаний и наименования продуктов могут являться товарными знаками соответствующих правообладателей.

Технология Thunderbolt и логотип Thunderbolt являются товарными знаками корпорации Intel в США и других странах.

Blackmagic Web Presenter





Gentile utente,

Grazie per aver acquistato Blackmagic Web Presenter!

Questa soluzione di streaming si collega direttamente a qualsiasi dispositivo SDI e converte il segnale in H.264 per trasmettere in diretta sulle più importanti piattaforme di streaming, tra cui YouTube Live, Facebook Live e Twitch. È anche ideale per trasmettere video professionale tramite internet da sorgente a destinazione con l'opzionale ATEM Streaming Bridge.

Questo manuale spiega come installare Web Presenter e come usarne le funzioni e i controlli, inclusa la configurazione per YouTube Live, Facebook Live, Twitch, Zoom e Skype.

La versione più recente di questo manuale e gli aggiornamenti del software interno di Web Presenter sono disponibili sulla pagina Supporto del nostro sito www.blackmagicdesign.com/it. Una volta scaricato il software, registra i tuoi dati personali per stare sempre al passo con gli aggiornamenti.

Blackmagic è in costante innovazione. I tuoi suggerimenti sono essenziali per consentirci di migliorare prestazioni e funzionalità.

Grant Petty

AD di Blackmagic Design

Indice

Primi passi	429
Pannello frontale	432
Display LCD	433
Utilizzare l'uscita monitor	434
Utilizzare l'utility Web Presenter Setup	439
Tab Live Stream	440
La tab Setup	443
Impostazioni di rete	444
Impostare la connessione internet per lo streaming diretto	444
Streaming con lo smartphone	445
Utilizzare Web Presenter come webcam	445
Configurare Open Broadcaster	445
Creare collegamenti video con ATEM Streaming Bridge	448
Creare un file XML	449
Esportare un file XML	449
Tally, Talkback e Controllo Camera	450
Collegare URSA Broadcast G2	451
Blackmagic Universal Rack Shelf	452
Contenuto del kit	452
Installare un dispositivo sul rack	453
Installare il pannello di copertura da 1/6	453
Installare il pannello di copertura da 1/3	453
Aggiornare il software interno	454
Developer Information	455
Blackmagic Web Presenter Ethernet Protocol	455
Protocol Blocks	457
Blackmagic Streaming XML Format	468
Overview	468
Streaming XML Definition	468
Assistenza clienti	475
Normative	476
Sicurezza	477
Garanzia	478

Primi passi

Configurare Web Presenter è facile e veloce. Collega l'alimentazione, la sorgente audio e video, connetti il dispositivo al computer e accedi a internet.

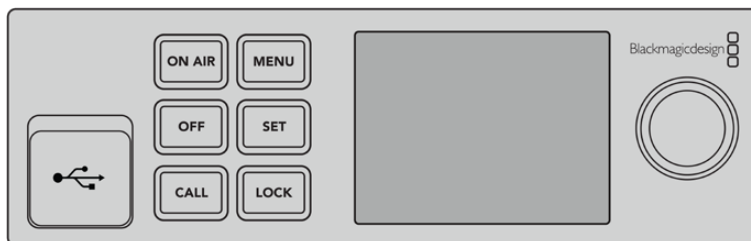

Pannello frontale di Web Presenter

Collegare l'alimentazione

Per alimentare il dispositivo, inserisci un cavo IEC standard nell'apposito ingresso sul retro del dispositivo.

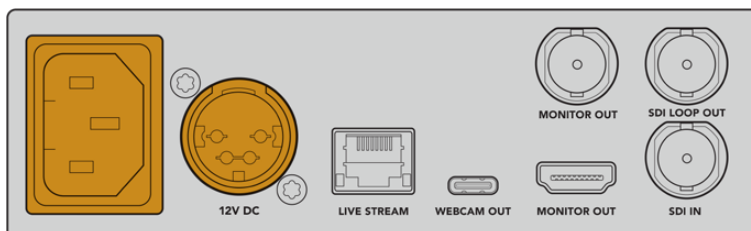

Web Presenter si alimenta tramite l'ingresso IEC o 12V DC

Web Presenter ha anche un ingresso DC 12V a cui puoi collegare una fonte di alimentazione esterna o di riserva, per esempio un gruppo statico di continuità (UPS) o una batteria 12V.

Collegare audio e video

Collega la sorgente video all'ingresso **SDI IN** e il video apparirà sul display LCD. L'audio è integrato nel segnale video SDI. Accertartene osservando i livelli audio sul display LCD.

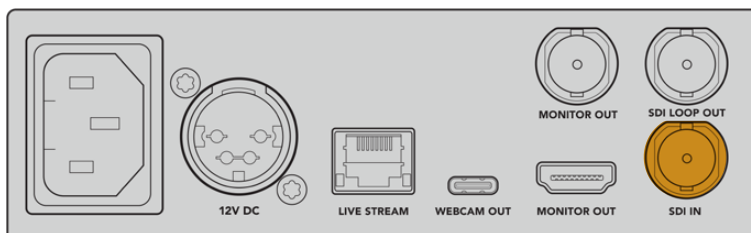

Collega la sorgente video all'ingresso SDI IN

Web Presenter supporta il 12G-SDI, e commuta automaticamente tra HD e Ultra HD fino al 2160p60. Mentre Web Presenter 4K effettua lo streaming in Ultra HD, Web Presenter HD converte qualsiasi segnale d'ingresso in 1080p.

Collegare un monitor

Collega un televisore HDMI o uno schermo SDI a una delle uscite **MONITOR OUT** per monitorare la trasmissione e altri importanti informazioni di stato che si aggiornano continuamente nel corso dello streaming. Per maggiori informazioni su come usare le uscite monitor vai alla sezione “Utilizzare l’uscita monitor”.

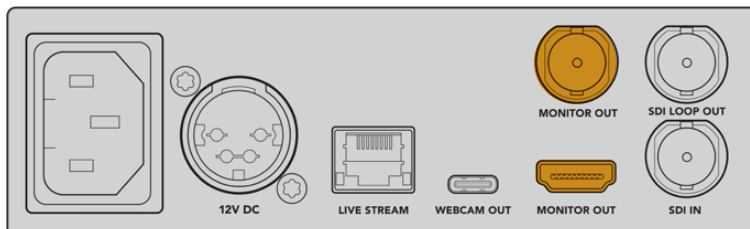

Collega uno schermo a una delle uscite MONITOR OUT

Collegare un computer tramite USB

Collega un computer tramite la porta USB-C sul pannello frontale o sul retro, per aggiornare il dispositivo e configurarlo tramite l’utilità Web Presenter Setup. Al termine della configurazione iniziale puoi scollegare il dispositivo dal computer.

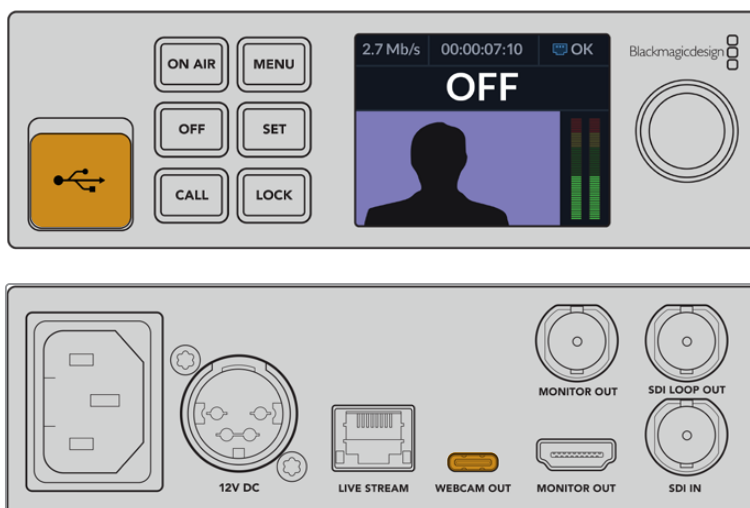

Collega il computer alla porta USB sul pannello frontale o sul retro

Collegarsi a internet

Collega Web Presenter a internet con un cavo di rete dalla porta ethernet **LIVE STREAM** a un router o a uno switch.

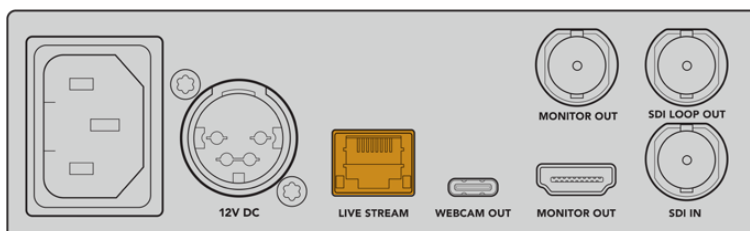

Collega Web Presenter alla rete tramite la porta ethernet sul retro

Configurare la diretta streaming

Ora puoi configurare Web Presenter per la diretta sulle piattaforme di streaming come YouTube Live, Facebook Live e Twitch. Questo esempio spiega come configurare la diretta su YouTube Live.

- 1 Copia il codice di streaming dal tuo account YouTube Studio.
- 2 Scarica l'utilità Blackmagic Web Presenter Setup dalla pagina www.blackmagicdesign.com/it/support e installala sul tuo computer. Il software consente la configurazione iniziale delle impostazioni di streaming.
- 3 Apri Blackmagic Web Presenter Setup e vai alla tab **Live Stream**.
- 4 Imposta **Platform** su **YouTube**, e **Server** su **Primary**. Incolla il codice di streaming di YouTube nel campo **Key** e seleziona la qualità. Clicca su **Save** per confermare.
- 5 Ora il dispositivo è pronto a trasmettere in tutto il mondo. Clicca sul pulsante **ON AIR** sul software o sul pannello frontale. Al termine della trasmissione, clicca sul pulsante **OFF** per interromperla.

Usare il protocollo di streaming SRT

Lo streaming con il protocollo di trasporto sicuro SRT ha una latenza inferiore rispetto al protocollo RTMP. Il protocollo SRT è anche più sicuro perché richiede una frase di accesso, simile a una chiave di crittografia.

Quando selezioni la versione del protocollo SRT del tuo servizio di streaming, copia la frase di accesso e il codice di streaming dal tuo account di streaming e incollali nel campo **Passphrase** e **Key** dell'utilità Blackmagic Web Presenter Setup.

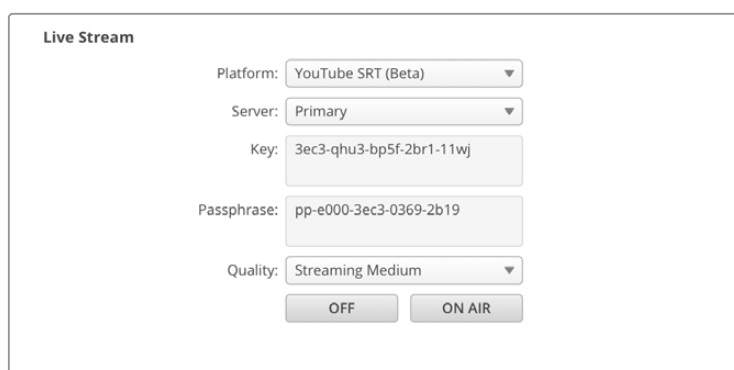

The screenshot shows a configuration window titled "Live Stream". It contains several fields and buttons:

- Platform:** A dropdown menu set to "YouTube SRT (Beta)".
- Server:** A dropdown menu set to "Primary".
- Key:** A text input field containing the alphanumeric string "3ec3-qhu3-bp5f-2br1-11wj".
- Passphrase:** A text input field containing the alphanumeric string "pp-e000-3ec3-0369-2b19".
- Quality:** A dropdown menu set to "Streaming Medium".
- At the bottom, there are two buttons: "OFF" and "ON AIR".

Incolla la frase di accesso nel campo Passphrase dell'utilità di configurazione

Con le competenze tecniche necessarie, nel file XML è possibile modificare sia i protocolli RTMP e SRT che i codec H.264 e H.265 per personalizzare le impostazioni di streaming. Consulta la sezione "Blackmagic Streaming XML Format" (in inglese) per maggiori informazioni.

Pannello frontale

Usa il pannello di controllo frontale di Web Presenter per avviare o interrompere lo streaming e cambiare le impostazioni.

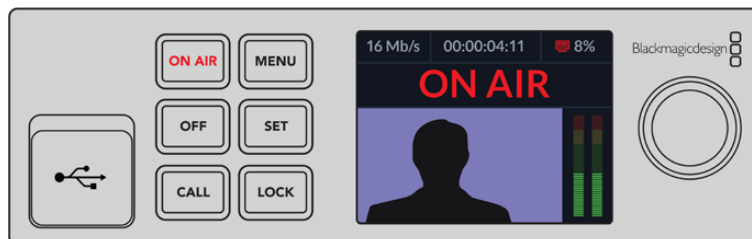

ON AIR – Avvia lo streaming. Il pulsante si illumina di rosso quando la diretta è in onda.



Se lampeggia indica che lo streaming non è iniziato o si è interrotto all'improvviso. Potrebbe dipendere da un problema di connessione a internet o di impostazioni di streaming. Controlla se la connessione funziona e se le impostazioni sono corrette.

OFF – Interrompe lo streaming.

MENU – Apre il menù impostazioni sul display LCD.

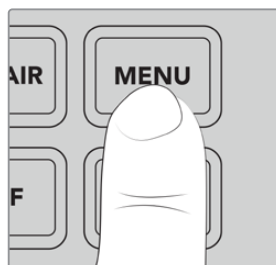

Cambiare le impostazioni:

1 Ruota la manopola per selezionare l'impostazione e premi **SET**.

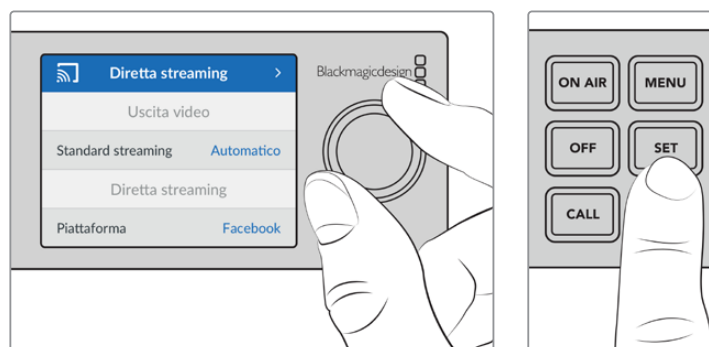

- 2 Ruota la manopola per cambiarla.
- 3 Premi di nuovo **SET** per confermare.

Premi **MENU** per tornare indietro alla schermata iniziale.

CALL – Questa funzione verrà abilitata con un aggiornamento futuro.

LOCK – Tieni premuto per 1 secondo per bloccare il pannello. I pulsanti sono ora disabilitati per evitare di andare in onda o interrompere lo streaming accidentalmente. Il tasto è illuminato di rosso quando è selezionato.

Per sbloccare il pannello, tienilo premuto per 2 secondi.

Display LCD

La schermata iniziale di Web Presenter mostra le seguenti informazioni:

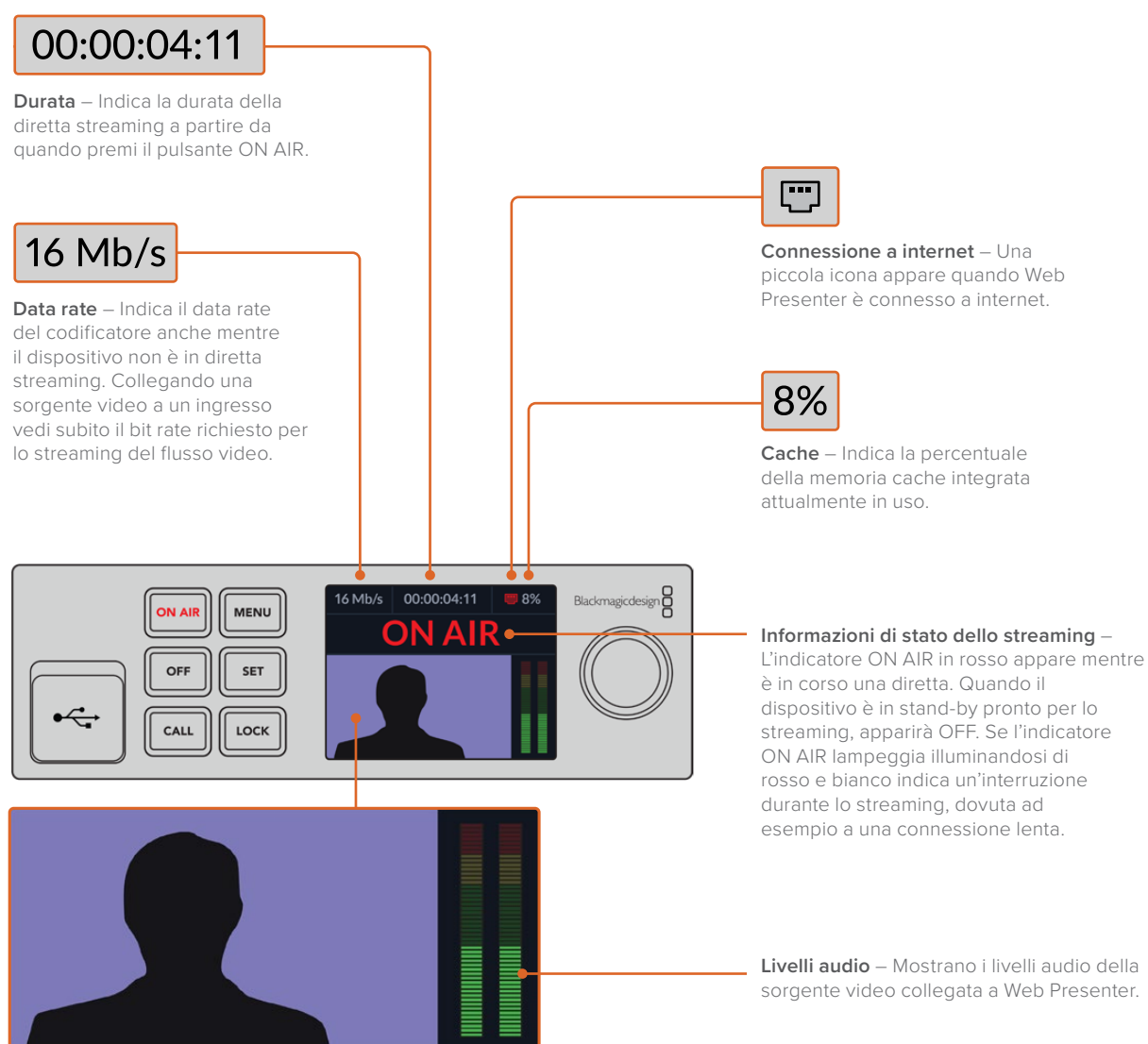

Display – Mostra la sorgente video collegata a Web Presenter.

Icone della connessione a internet



Un'icona di ethernet blu appare quando è collegato un cavo ethernet e questa connessione verrà utilizzata per lo streaming.



Un'icona di ethernet rossa appare quando il dispositivo è in onda e lo streaming avviene tramite ethernet.



Un'icona di smartphone blu appare quando viene utilizzata la connessione internet del telefono per lo streaming.



Un'icona di smartphone rossa appare quando il dispositivo è in onda e lo streaming avviene tramite la connessione internet del telefono.

SUGGERIMENTO Se non appare alcuna icona Web Presenter non è collegato alla rete.

Utilizzare l'uscita monitor

L'uscita monitor è utile per monitorare l'ingresso video, i livelli audio, lo stato dello streaming, il data rate e i livelli della cache, oltre alle specifiche tecniche dell'ingresso SDI.



L'uscita di monitoraggio di Blackmagic Web Presenter fornisce tutte le informazioni necessarie, tra cui data rate e stato della cache

Il display è composto da otto sezioni, ognuna descritta qui sotto con le informazioni contenute.

Video in entrata

La sezione principale mostra il flusso in arrivo dalla sorgente video SDI collegata.



Stato dello streaming

Prima che inizi lo streaming, **OFF** indica che il dispositivo è in stand by e pronto a trasmettere. **ON AIR** in rosso appare quando inizia lo streaming e per tutta la sua durata.



La durata dello streaming appare sotto l'indicatore e parte non appena premi **ON AIR**.

Se Web Presenter non è in onda, ma è collegato alla connessione internet di uno smartphone, apparirà anche l'icona blu di un telefono in alto a destra. L'icona si illumina di rosso quando parte lo streaming.

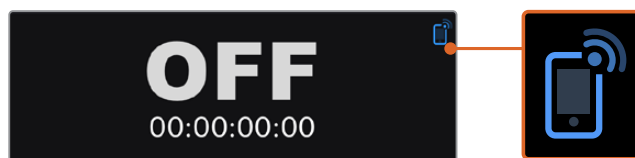

Diretta streaming

Mostra le impostazioni utilizzate per la diretta, tra cui la piattaforma di streaming, il server e il protocollo. Indica anche la risoluzione e la qualità dello streaming.

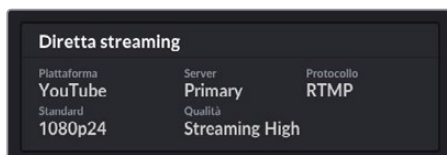

Ingresso video

I cinque mini visualizzatori in alto in questa sezione mostrano gli ultimi 6 secondi di diretta divisi per 1,2 secondi ciascuno.

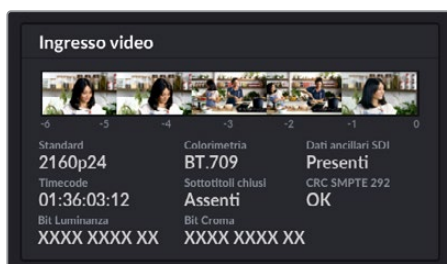

Subito sotto trovi informazioni tecniche dettagliate sulla sorgente video collegata all'ingresso SDI del dispositivo.

Standard	Mostra la risoluzione e il frame rate dell'ingresso SDI. Web Presenter supporta fino al 2160p60.
Colorimetria	Mostra lo spazio colore del video in entrata dall'ingresso SDI. Web Presenter supporta gli spazi colore Rec.601, Rec.709 e Rec.2020.
Dati ancillari SDI	Sono dati aggiuntivi al video inviati tramite SDI, tra cui audio integrato, timecode e sottotitoli chiusi. Se il video contiene dati ancillari è indicato con "Presenti".
Timecode	Mostra il timecode della sorgente video SDI.
Sottotitoli chiusi	Se inclusi nel video SDI sono indicati con "Presenti". Web Presenter HD supporta i formati CEA-608 e CEA-708.
CRC SMPTE 292	È una funzione di verifica errori per il video SDI. Se il dispositivo rileva un problema nell'ingresso video SDI lo indica con "Errore". Gli errori CRC sono in genere causati da un cavo SDI difettoso o troppo lungo.
Bit luminanza Y e Bit croma	<p>Mostrano l'attività del segnale video SDI. Ogni lettera rappresenta lo stato di uno dei bit del segnale video.</p> <p>X – Indica un bit rate che cambia di continuo.</p> <p>L – Indica un bit rate basso.</p> <p>H – Indica un bit rate alto.</p> <p>Per facilitare la lettura gli scarti SDI vengono omessi. Ad esempio, tutti i bit sono bassi quando il video è nero.</p> <p>In genere, tutti e 10 i bit dell'ingresso video SDI mostrano una "X" ad indicare che ogni bit dello streaming video cambia di continuo. Se la sorgente SDI è un video a 8 bit, le ultime due cifre sulla destra saranno sempre contrassegnate con "L" poiché non contengono dati. Se un bit mostra una "L" o una "H" dove dovrebbe esserci una "X", segnala un bit bloccato e potrebbe indicare una falla nel flusso video sorgente.</p>

Ingresso audio

La forma d'onda audio in alto in questa sezione mostra le informazioni audio degli ultimi 6 secondi della diretta e si aggiorna di continuo ondeggiando da destra verso sinistra.

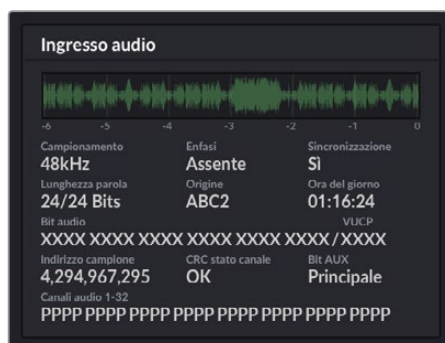

Subito sotto trovi informazioni tecniche dettagliate sull'audio.

Campionamento	Mostra la frequenza di campionamento dell'audio integrato nella sorgente SDI.
Enfasi	Indica se è abilitata o meno l'enfasi della sorgente audio.
Sincronizzazione	Indica se la sorgente audio è sincronizzata a una fonte di riferimento esterna.
Lunghezza parola	Mostra la profondità di bit dell'audio integrato nell'ingresso SDI.
Origine	I quattro caratteri indicano l'origine del canale.
Ora del giorno	Timecode continuo.
Bit audio	Mostra l'attività dei bit nei campioni audio integrati nella connessione SDI. Anche se lo stato del canale audio indica la presenza di 16, 20 o 24 bit audio, la conferma è nell'attività dei bit.
VUCP	Il codice alfanumerico indica, da destra a sinistra, "V" per bit valido, "U" per bit "utente", "C" per bit "stato canale" e "P" per "parità". È simile alla voce Bit audio.
Indirizzo campione	Contatore dei campioni audio.
Bit AUX	Indica se vi sono bit AUX in uso nell'audio principale.
Canali audio 1–32	Ogni cifra rappresenta un canale audio integrato nell'ingresso SDI. Una "P" indica un canale audio in uso e un trattino "–" indica un canale vuoto.

Data rate

Mostra il data rate del codificatore negli ultimi 60 secondi. Il trasferimento dati è misurato in megabit al secondo. L'indicatore è sempre attivo, anche quando non sei in onda, in modo da stimare con precisione la larghezza di banda prima di iniziare la diretta.

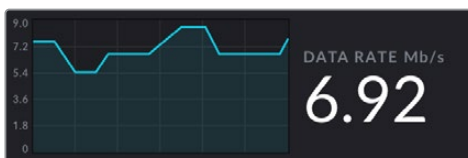

Cache

Mostra la percentuale di utilizzo del buffer di memoria integrato nel Web Presenter. Il grafico indica la quantità utilizzata negli ultimi 60 secondi. La cache è una piccola memoria interna che registra e riproduce continuamente il programma in uscita e funge da backup se il data rate di streaming scende al di sotto del livello necessario per sostenere il video.

La variabilità della connessione internet è dovuta alle attività di rete e alla potenza del segnale wireless, pertanto al diminuire della velocità di trasferimento, aumentano i dati di buffer. Se la velocità della connessione è troppo bassa per sostenere lo streaming, la cache si riempie di fotogrammi video per compensarvi. Quando la cache è piena al 100%, lo streaming ne risente, quindi è importante evitare di raggiungere la massima capacità. Per testare la capacità collega un flusso video e guarda la sezione della cache sul display senza necessità di avviare lo streaming. Se il valore è vicino a 100%, scegli un'opzione di qualità più bassa nelle impostazioni.



Livelli audio

Disponibili come PPM o VU, servono a monitorare i livelli della sorgente audio e sono selezionabili nel menù impostazioni del dispositivo. Se i livelli sono troppo alti gli indicatori si illuminano di rosso a indicare che l'audio dello streaming potrebbe subire distorsioni o clipping. La posizione ideale è nella parte alta della zona verde con picchi sporadici nella parte gialla.

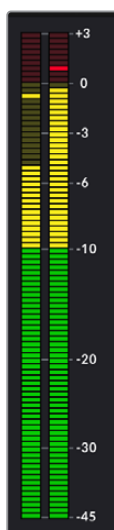

Utilizzare l'utility Web Presenter Setup

Collegando Web Presenter alla rete, qualsiasi computer nella stessa rete è in grado di controllare il dispositivo in remoto. Blackmagic Web Presenter Setup offre accesso a tutti i controlli e le impostazioni disponibili sul pannello frontale.

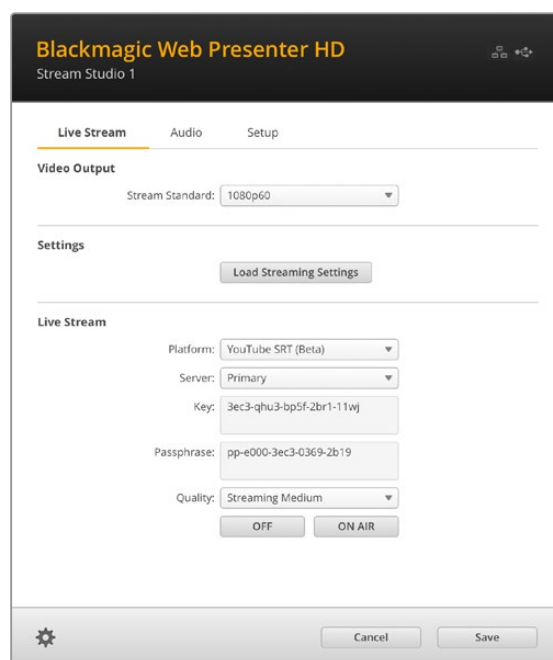
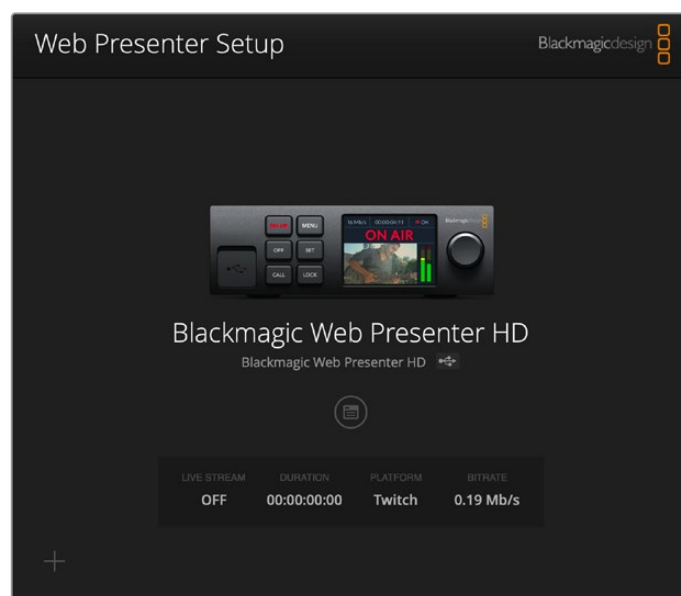

Tab Live Stream

Video Output

Stream Standard

Clicca sul menù a discesa per scegliere la risoluzione video dello streaming, che va da 720p25 fino a 1080p60 o 2160p60 a seconda del modello di Web Presenter utilizzato.

Settings

Se hai delle impostazioni personalizzate per lo streaming, come ad esempio un file XML da ATEM Streaming Bridge, importalo cliccando su **Load Streaming Settings**.

Per maggiori informazioni su come personalizzare le impostazioni e collegarsi ad ATEM Streaming Bridge consulta la sezione “Creare collegamenti video con ATEM Streaming Bridge” di questo manuale.

Live Stream

Platform

Seleziona una piattaforma di streaming per la tua trasmissione. Le opzioni includono YouTube, Facebook e Twitch. Se hai importato impostazioni di streaming personalizzate, le troverai in questo menù.

Per trasmettere su un URL specifico, selezionalo dal menù a discesa. Web Presenter 4K permette di scegliere tra le opzioni H.264 e H.265; Web Presenter HD offre solo l'opzione H.264.

Server

Seleziona il server più vicino alla tua postazione. Le opzioni disponibili variano a seconda della piattaforma di streaming scelta.

Se scegli di trasmettere su Instagram, su Microsoft Teams o su un URL specifico, questo menù a discesa diventa un campo modificabile. Inserisci l'URL assegnato dall'account della tua piattaforma di streaming o l'URL specifico.

Key

Inserisci il codice di streaming assegnato alla trasmissione dalla piattaforma di streaming.

Passphrase

Se usi un servizio di streaming con il protocollo di streaming SRT, inserisci la frase di accesso assegnata dall'account della tua piattaforma di streaming.

Quality

A seconda del modello di Web Presenter utilizzato, seleziona la qualità dello streaming in HD o 4K tra le seguenti opzioni:

H.264	
HD	4K
HyperDeck High 45 to 70 Mb/s (alta)	HyperDeck High 95 to 220 Mb/s (alta)
HyperDeck Medium 25 to 45 Mb/s (media)	HyperDeck Medium 66 to 150 Mb/s (media)
HyperDeck Low 12 to 20 Mb/s (bassa)	HyperDeck Low 38 to 80 Mb/s (bassa)
Streaming High 6 to 9 Mb/s (alta)	Streaming High 34 to 51 Mb/s (alta)
Streaming Medium 4.5 to 7 Mb/s (media)	Streaming Medium 23 to 35 Mb/s (media)
Streaming Low 3 to 4.5 Mb/s (bassa)	Streaming Low 13 to 20 Mb/s (bassa)

H.265	
HD	4K
Streaming High 2.3 to 4.5 Mb/s (alta)	Streaming High 22.5 to 30 Mb/s (alta)
Streaming Medium 1.5 to 3 Mb/s (media)	Streaming Medium 14 to 20 Mb/s (media)
Streaming Low 0.8 to 2 Mb/s (bassa)	Streaming Low 8 to 10 Mb/s (bassa)

Il data rate determinato dall'opzione di qualità cambia in base allo standard video adoperato da Web Presenter. Per esempio selezionando l'opzione Streaming High (qualità alta), con lo standard 1080p24, il trasferimento dati sarà di 6 Mb/s.

Come indicato dalla tabella, i data rate delle opzioni di Streaming sono più bassi rispetto a quelli di HyperDeck, per consentire la trasmissione dati su internet che in genere ha una minore larghezza di banda rispetto alla quella della registrazione su disco.

Ciascuna opzione contiene due valori: il primo viene utilizzato per i frame rate bassi di 24p, 25p, e 30p, il secondo per i frame rate più alti di 50p e 60p. L'impostazione di default è Streaming High, che garantisce uno streaming ottimale di alta qualità.

Pulsanti ON AIR e OFF

Usali per avviare e interrompere lo streaming. Il pulsante ON AIR si illumina di rosso durante la diretta.

Eliminare le impostazioni importate

Per rimuovere tutte le impostazioni di streaming importate da Web Presenter, clicca sull'icona dell'ingranaggio in basso a sinistra nella tab Live Stream. Clicca su **Remove** per confermare.

La tab Audio

Questa tab consente di configurare l'uscita di monitoraggio audio e gli indicatori di livello di Web Presenter.

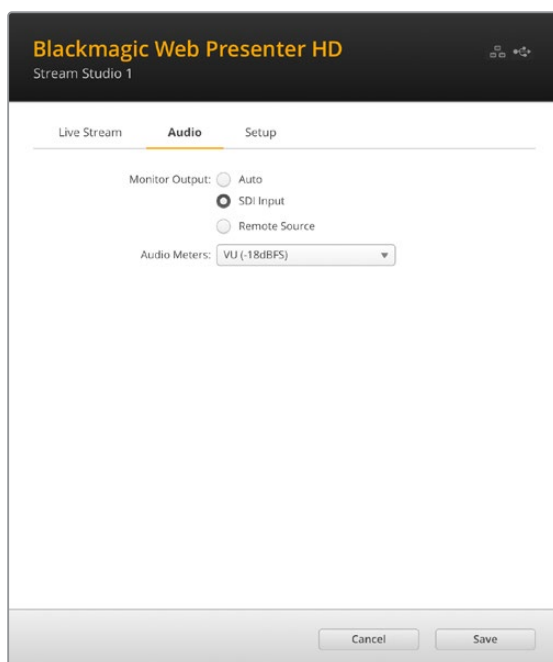

Monitor Output

Seleziona la sorgente audio per l'uscita di monitoraggio SDI o HDMI di Web Presenter.

Auto

Con questa opzione Web Presenter rileva e monitora automaticamente l'audio del talkback inviato da uno switcher ATEM attraverso ATEM Streaming Bridge. In assenza di audio del talkback, il dispositivo seleziona l'ingresso SDI.

SDI Input

Con questa opzione puoi monitorare l'audio della sorgente connessa all'ingresso SDI di Web Presenter, per esempio di una Blackmagic Studio Camera.

Remote Source

Con questa opzione puoi monitorare l'audio del talkback inviato da uno switcher ATEM remoto o da ATEM Streaming Bridge.

Audio Meters

Seleziona il tipo di misurazione dei livelli audio, a scelta tra VU -18dBFS, VU -20dBFS, PPM -18dBFS o PPM -20dBFS.

La tab Setup

Blackmagic Web Presenter HD
Stream Studio 1

Live Stream Audio **Setup**

Name: Stream Studio 1
Language: English
Software: Version 3.3

Network

Protocol: DHCP Static IP
IP Address: 192.168.24.100
Subnet Mask: 255.255.255.0
Gateway: 192.168.24.1
Primary DNS: 8.8.8.8
Secondary DNS: 8.8.4.4
Connection Priority: Ethernet Mobile

Reset

Factory Reset

Cancel Save

Name

Per assegnare un altro nome a Web Presenter, digitalo nel riquadro e clicca **Save**.

Language

Scegli la lingua di utilizzo del dispositivo dal menù a discesa.

Software

Mostra la versione corrente del software di Web Presenter.

Network

Usa queste impostazioni per configurare opzioni quali la connessione di rete tramite DHCP o un indirizzo IP statico. Per maggiori informazioni su come connettere Web Presenter a una rete, consulta la sezione "Impostazioni di rete".

Connection Priority

Quando il dispositivo è connesso sia a ethernet che a uno smartphone, seleziona quale dei due usare per lo streaming. Per maggiori informazioni su come usare la connessione di un telefono, consulta la sezione "Streaming con lo smartphone".

Reset

Premi **Factory Reset** per resettare il dispositivo.

Impostazioni di rete

Web Presenter si collega alla rete tramite un indirizzo IP statico o DHCP.

DHCP – Configura automaticamente un indirizzo IP per il dispositivo e si collega alla rete senza modificare le impostazioni.

Il protocollo di configurazione IP dinamica (DHCP) è un servizio sui server di rete e router che trova e assegna automaticamente a Web Presenter un indirizzo IP. Facilita la connessione tra dispositivi tramite ethernet, facendo in modo che gli indirizzi IP non entrino in conflitto tra loro. La maggior parte dei computer e degli switch è compatibile con il DHCP.

Static IP – Per impostare manualmente un indirizzo IP, seleziona **Static IP** e inseriscilo nel riquadro **IP Address**.

L'indirizzo IP statico non cambia se il dispositivo viene riavviato e potrebbe essere necessario per collegare Web Presenter a una rete aziendale. Se la tua rete è gestita da un amministratore è probabile che ogni dispositivo ad essa connesso richieda un indirizzo IP specifico. In questo caso è consigliabile rivolgersi all'amministratore di rete prima di procedere.

Impostare la connessione internet per lo streaming diretto

Se non ti è possibile collegare Web Presenter a uno switch o a un router internet puoi condividere la connessione internet del tuo computer con Web Presenter tramite la porta ethernet.

Come impostare lo streaming diretto:

- 1 Su Web Presenter seleziona l'impostazione **DHCP**.
- 2 Configura il computer per condividere la connessione internet tramite la porta ethernet.

Su Mac: Vai su **Preferenze di sistema**, clicca su **Condivisione** e seleziona **Condivisione internet** dal menù a discesa **Servizio**. Nella finestra **Condividi la tua connessione da:** seleziona **Wi-fi** se il tuo Mac è collegato tramite wi-fi. Nella finestra **Ai computer che usano:** seleziona **Ethernet**. Spunta la casella **Condivisione internet** nel menù a discesa **Servizio**. Quando ti verrà chiesto se sei sicuro di voler avviare la condivisione internet clicca **Avvia**.

Su Windows: Fai clic destro su **Avvio** e seleziona **Connessioni di rete**. Apparirà la finestra **Stato della rete**. Clicca su **Modifica opzioni scheda** per visualizzare le connessioni di rete. Fai clic destro sulla connessione internet e seleziona **Proprietà**. Nella finestra **Condivisione** spunta **Consenti ad altri utenti in rete di collegarsi tramite la connessione Internet di questo computer**. Seleziona una connessione di rete dal menù e conferma con **OK**.

- 3 Collega Web Presenter alla porta ethernet del computer. Dopo qualche secondo, il DHCP assegnerà un indirizzo IP a Web Presenter.
- 4 Accertati che il dispositivo sia connesso a internet tramite ethernet osservando se è apparsa l'icona di ethernet in alto a destra sul display LCD.

Streaming con lo smartphone

Web Presenter è in grado di trasmettere lo streaming tramite la connessione internet del tuo smartphone. Per fare una diretta da qualsiasi parte del mondo basta quindi una connessione cellulare.

Per condividere la connessione del telefono:

- 1 Collega lo smartphone con un cavo USB-C sul retro o sul pannello frontale di Web Presenter.
- 2 Abilita l'hotspot dello smartphone.

Sui dispositivi iOS apri **Impostazioni** e su **Hotspot personale** assicurati di abilitare l'opzione **Consenti agli altri di accedere**. Sui dispositivi Android passa il dito sullo schermo per visualizzare il menù rapido. Tieni premuta l'icona di hotspot e avvia il tethering USB.

Ora basta premere il pulsante **ON AIR** su Web Presenter per iniziare la diretta.

SUGGERIMENTO A conclusione dello streaming disabilita il tethering per risparmiare la batteria dello smartphone.

In presenza di un cavo ethernet connesso a Web Presenter, è consigliabile confermare se sia configurato per l'utilizzo con il tethering del telefono. Apri l'utilità Web Presenter Setup e vai alla tab **Setup**. Nella sezione **Network** seleziona **Mobile** nelle opzioni **Connection Priority**.

Utilizzare Web Presenter come webcam

Piattaforme come Skype e Zoom rilevano automaticamente Web Presenter come fosse una webcam, e basta lanciare l'applicazione per vedere immediatamente il video proveniente dal dispositivo. Se questo non dovesse accadere configura manualmente Web Presenter come webcam e microfono.

Su Skype:

- 1 Nella barra del menù di Skype, apri **Audio e video**.
- 2 Nel menù a discesa **Videocamera**, seleziona **Web Presenter**. L'anteprima mostrerà il video proveniente dal dispositivo.
- 3 Nel menù a discesa **Microfono**, seleziona **Web Presenter** come sorgente audio.

Configurare Open Broadcaster

Open Broadcaster è un'applicazione open source che funge da piattaforma di streaming tra Web Presenter e i software di streaming come YouTube, Twitch e Facebook Live. Open Broadcaster comprime il video in un bit rate facilmente gestibile dalla tua applicazione di streaming.

L'esempio qui sotto spiega come impostare Open Broadcaster per trasmettere in streaming l'uscita webcam di Web Presenter usando YouTube Live come servizio di streaming.

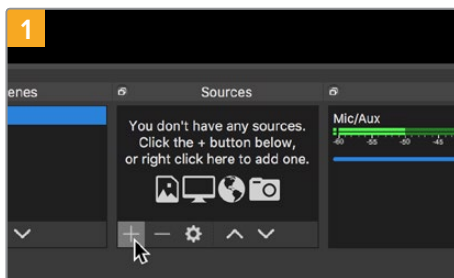

Lancia Open Broadcaster e clicca il simbolo + nella sezione **Origini**.

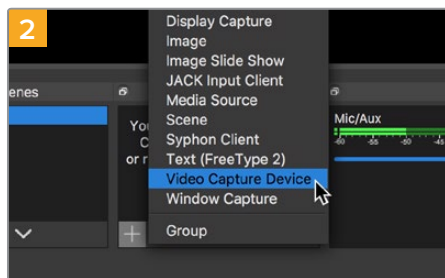

Seleziona **Dispositivo di cattura** dalla lista.

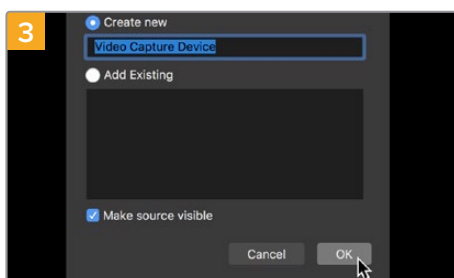

Assegna un nome al dispositivo di cattura e conferma con **OK**.

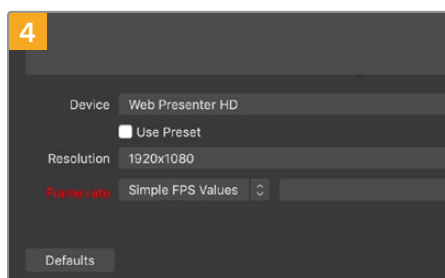

Alla voce **Dispositivo** seleziona il tuo modello di Web Presenter e conferma con **OK**.

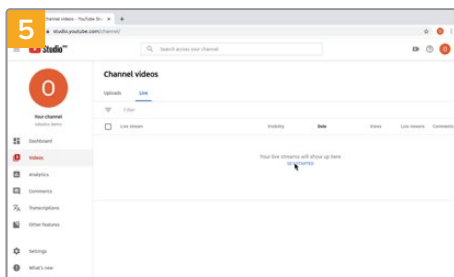

Accedi al tuo account di YouTube. Seleziona **Dal vivo** e clicca **Inizia**.

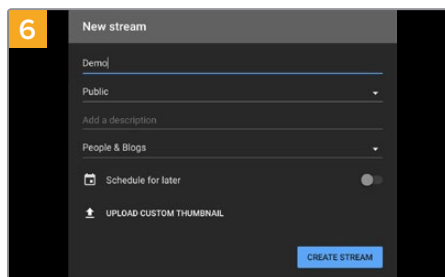

Nella sezione **Stream**, inserisci i dettagli della trasmissione e clicca **Crea stream**.

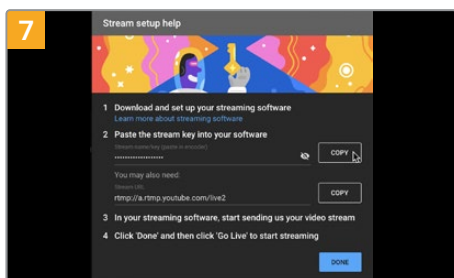

YouTube genererà un codice di streaming che reindirizza Open Broadcaster al tuo account di YouTube. Clicca **Copia** per copiare il codice di streaming che dovrai incollare su Open Broadcaster.

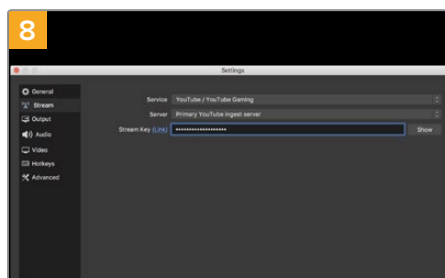

Su Open Broadcaster, apri le preferenze cliccando **OBS/Impostazioni** nella barra del menù e seleziona **Stream**. Incolla la chiave di streaming copiata da YouTube e procedi con **OK**.

Il flusso video di Web Presenter apparirà nella finestra di anteprima di Open Broadcaster.

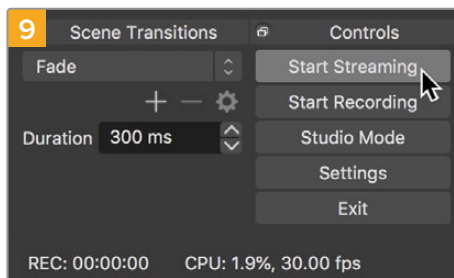

Per connettere Open Broadcaster a YouTube, clicca **Avvia trasmissione** in basso a destra. Da questo momento in poi, Open Broadcaster comunicherà unicamente con YouTube Live.

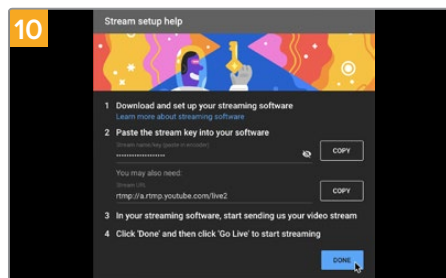

Torna su YouTube Live. Sullo sfondo vedrai il programma dell'uscita webcam di Web Presenter. Clicca **Fine**.

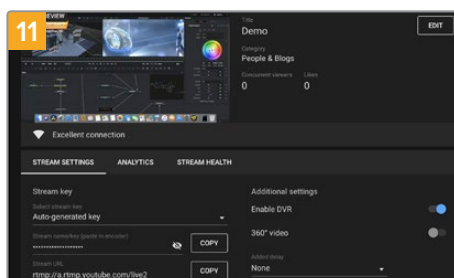

A questo punto puoi iniziare a trasmettere. Fai gli ultimi controlli per assicurarti che tutto sia configurato correttamente.

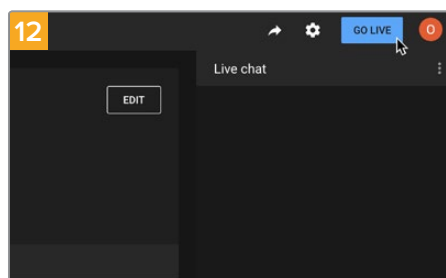

Clicca **Trasmetti dal vivo** per avviare la diretta streaming.

Ora sei in onda su YouTube con Open Broadcaster.

NOTA È probabile che durante la trasmissione in streaming ci sia un ritardo. È quindi consigliabile seguirla su YouTube per assicurarti che sia giunta effettivamente al termine prima di chiuderla con **Termina streaming**.

Creare collegamenti video con ATEM Streaming Bridge

ATEM Streaming Bridge decodifica il video di streaming proveniente da Web Presenter e lo converte in video SDI o HDMI, consentendo di inviarlo sulla rete locale e ovunque al mondo tramite internet.

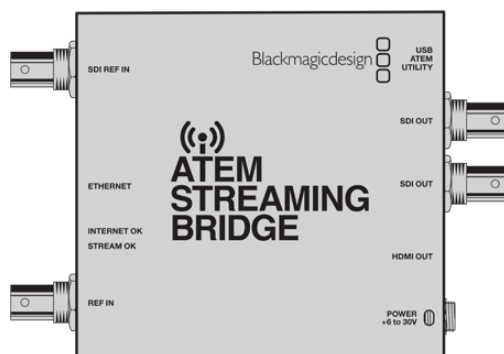

Se ATEM Streaming Bridge è connesso alla stessa rete locale di Web Presenter comparirà nel menù **Platform** della tab **Live Stream** sull'utilità Web Presenter Setup.

In alternativa, carica un file XML con le impostazioni di streaming su un drive USB collegato a Web Presenter o tramite l'utilità Web Presenter Setup sul tuo computer.

Un ottimo esempio di come usare Web Presenter con ATEM Streaming Bridge è la trasmissione delle previsioni del tempo da una location in remoto allo studio. Basta avere un Web Presenter e una connessione a internet, accessibile attraverso la rete o tramite uno smartphone.

Nello studio, ATEM Streaming Bridge riceve il flusso internet e lo converte in SDI in modo da farlo arrivare allo switcher principale.

Sotto trovi un esempio di questo workflow:

- 1 Nella location in remoto collega Blackmagic Web Presenter all'uscita di programma SDI dello switcher, ad esempio un ATEM Constellation 8K.
- 2 Collega Web Presenter a uno smartphone.
- 3 Nello studio, ATEM Streaming Bridge è collegato a internet tramite ethernet.
- 4 ATEM Streaming Bridge riceve da internet e invia il flusso video convertito in SDI all'ingresso SDI dello switcher in studio affinché venga trasmesso durante il telegiornale.

Per collegare ATEM Streaming Bridge in studio al flusso internet del Web Presenter, lancia l'utilità ATEM Setup e configura le impostazioni internet. L'utilità genererà un file XML con le informazioni di streaming da caricare sul Web Presenter nella location in remoto.

Creare un file XML

Per creare un file XML connetti ATEM Streaming Bridge a internet collegando la porta ethernet a un router o a un interruttore di rete.

Con un cavo USB-C collega ATEM Streaming Bridge al computer e lancia ATEM Setup.

Nella tab Setup controlla che le impostazioni di rete siano corrette e seleziona **Internet** nelle opzioni **Stream service**. Nella finestra di stato di internet apparirà il messaggio 'Visible Worldwide', per indicare che tutto funziona correttamente.

Nota sul port forwarding

Se nella finestra di stato di internet compare un errore di port forwarding o UPnP, chiedi al tuo fornitore di servizi internet o al tuo amministratore di rete di impostare il port forwarding della tua connessione internet su 'TCP port 1935'.

Esportare un file XML

Dopo aver confermato le impostazioni nella tab ATEM Setup e aver collegato ATEM Streaming Bridge alla tua rete o a internet, puoi esportare il file XML.

- 1 Apri la tab **External ATEM Mini Pro** in alto a destra.

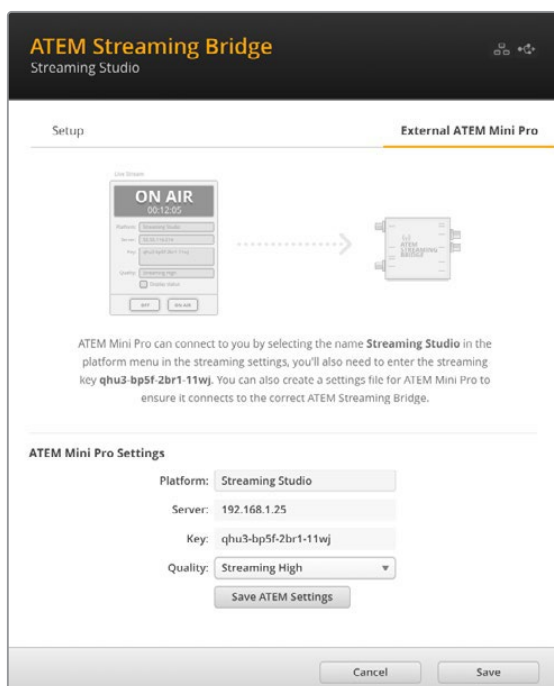

- 2 Per assegnare un nome alla piattaforma, nel menù a discesa **Platform** digita il nome prescelto, con il quale comparirà nelle impostazioni di streaming del dispositivo.
- 3 Scegli la qualità dello streaming di Web Presenter alla voce **Quality**.
- 4 Clicca su **Save ATEM Settings**, seleziona la destinazione sul computer dove salvare il file XML e clicca **Save**.
- 5 Invia per email il file XML all'operatore in remoto.

SUGGERIMENTO Usa le impostazioni di talkback nella tab Setup per selezionare i canali di ritorno audio da inviare al Web Presenter remoto.

Caricare un file XML

Per iniziare la diretta delle previsioni del tempo dalla location in remoto verso lo studio, alla troupe sul posto basta caricare sul dispositivo, tramite l'utility Web Presenter, il file XML con le impostazioni di streaming ricevuto per email, e premere ON AIR.

Dopo aver caricato il file XML la prima volta, non è più necessario ricaricarlo per avviare e interrompere lo streaming. È quindi semplicissimo attivare il collegamento video tra Web Presenter e ATEM Streaming Bridge.

L'ATEM Streaming Bridge nello studio infatti, a condizione che non siano cambiate le impostazioni di streaming e di rete, cercherà e troverà Web Presenter ovunque si trovi collegato a internet. In qualsiasi location basta collegare Web Presenter a internet, premere ON AIR e invierà immediatamente lo streaming all'ATEM Streaming Bridge in studio.

Per maggiori informazioni su come usare ATEM Streaming Bridge consulta il manuale di ATEM Mini, disponibile per il download sulla pagina www.blackmagicdesign.com/it/support.

Tally, Talkback e Controllo Camera

ATEM Streaming Bridge e Blackmagic Web Presenter consentono anche agli switcher ATEM di inviare segnali di tally, talkback e controllo camera. In questo modo puoi connettere qualsiasi camera Blackmagic Design con SDI alla tua rete locale, o ovunque nel mondo tramite internet, e operare tally, talkback e controllo camera.

La configurazione è semplice. L'immagine sotto mostra come collegare URSA Mini Pro 4.6K a un ATEM Constellation 8K in una rete locale con tally, talkback e controllo camera.

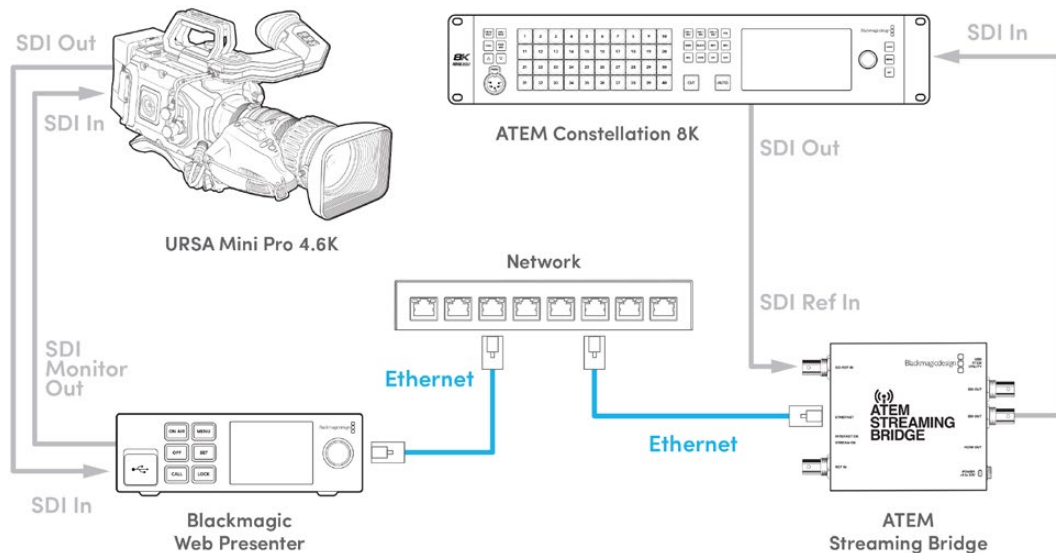

Dopo aver collegato i dispositivi:

- 1 Premi il tasto **Menu** su Blackmagic Web Presenter per aprire il display LCD e vai su **Live Stream**.
- 2 Seleziona ATEM Streaming Bridge alla voce **Platform**.
- 3 Premi **Set** per confermare.

Per un corretto funzionamento del tally, assicurati che l'ID ATEM della camera corrisponda a quello dell'ingresso dello switcher ATEM. Per informazioni su come impostare correttamente l'ID ATEM della camera consulta il manuale di URSA Mini.

Per testarne il funzionamento, commuta la camera sull'uscita di programma dello switcher ATEM. Se l'ID ATEM della camera è impostato correttamente sulla camera, la spia tally si illuminerà e un bordo rosso circonda il display LCD della camera. Se commuti la camera all'uscita di anteprima, il tally si illuminerà di verde.

Per testare il controllo camera prova a regolare diaframma e livelli del nero dalla tab Camera di ATEM Software Control.

I canali audio 15 e 16 integrati nel segnale SDI sono destinati di default al talkback, ma puoi sostituirli con i canali 13 e 14 per il team tecnico, o con l'uscita di programma dall'utility ATEM Setup.

Quando si trasmette su internet, ATEM Setup genera un file XML che una volta caricato su Blackmagic Web Presenter consente di individuare ATEM Streaming Bridge su internet. Per maggiori informazioni su come creare e caricare il file XML consulta la sezione precedente del manuale.

Collegare URSA Broadcast G2

URSA Broadcast G2 è dotata di un motore di streaming integrato che elimina la necessità di usare Blackmagic Web Presenter, perché la camera può inviare lo streaming direttamente dalla propria porta di espansione USB-C.

Per maggiori informazioni, incluso come impostare correttamente l'ID ATEM della camera, consulta il manuale di URSA Broadcast G2.

Blackmagic Universal Rack Shelf

Blackmagic Universal Rack Shelf è una mensola di 1RU che consente di installare una vasta gamma di prodotti Blackmagic Design nei rack per il broadcast o nei flight case. Questo design modulare permette di costruire impianti pratici e portatili composti da dispositivi con lo stesso fattore forma di una unità di rack.

L'immagine sotto mostra 3 mensole Universal Rack Shelf installate in un piccolo rack e contenenti un mix di dispositivi compatibili. L'ultima mensola include un pannello di copertura largo 1/3 di rack, che copre lo spazio inutilizzato tra le varie unità installate.

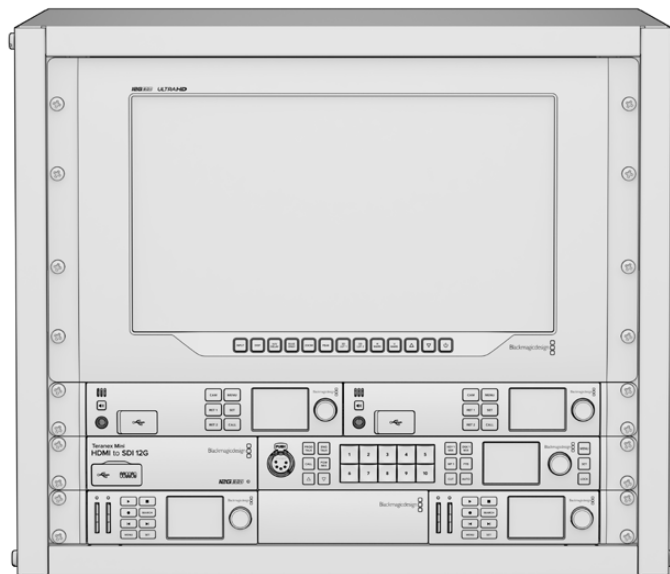

Contenuto del kit

L'Universal Rack Shelf Kit contiene:



1 x Blackmagic Universal Rack Shelf

Mensola per rack di larghezza intera e di 1RU di altezza per installare dispositivi Blackmagic Design.

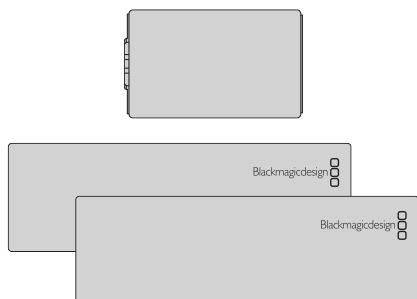

Pannelli di copertura

1 x pannello di copertura largo 1/6 di rack e 2 pannelli di copertura larghi 1/3 di rack per coprire gli spazi inutilizzati.

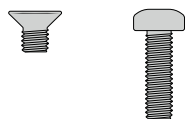

Viti

12 x viti M3 5mm a testa svasata per il montaggio.

2 x viti M3 9mm piatte per i pannelli di copertura larghi 1/6 di rack.

Installare un dispositivo sul rack

- 1 Se il dispositivo è dotato di piedini di gomma, rimuovili dalla base con un raschietto con lama in plastica.
- 2 Capovolgi la mensola e il dispositivo facendo corrispondere i fori della mensola con quelli filettati alla base del dispositivo Blackmagic Design. Ci sono due fori centrali di montaggio nei dispositivi larghi 1/3 di rack e tre fori per le unità più larghe di 1/2 di rack.

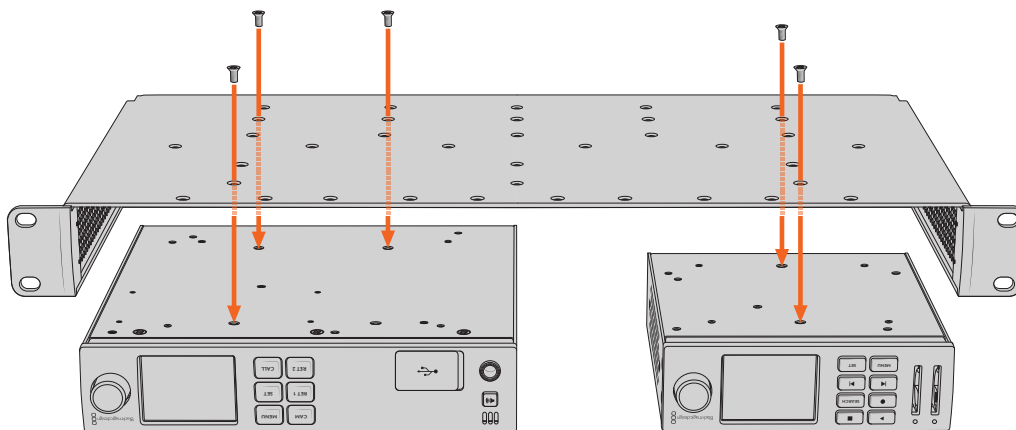

- 3 Utilizza le viti M3 5mm a testa svasata in dotazione per fissare il dispositivo alla mensola.
- 4 Dopo aver serrato le viti capovolgi la mensola e installala al rack tramite le alette integrate.

Utilizza i pannelli di copertura in dotazione per coprire lo spazio inutilizzato sul rack.

Installare il pannello di copertura da 1/6

Utilizza il piccolo pannello di copertura da 1/6 di rack per coprire lo spazio inutilizzato sul rack quando installi dispositivi larghi 1/2 o 1/3 di rack. Il pannello si può fissare sul lato di una delle due unità, a scelta. Per favorire il flusso dell'aria si consiglia di montare il pannello nella parte centrale, tra i due dispositivi.

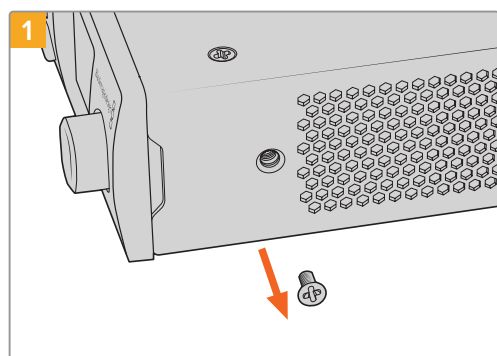

Rimuovi la vite M3 5mm vicino alla parte frontale del dispositivo

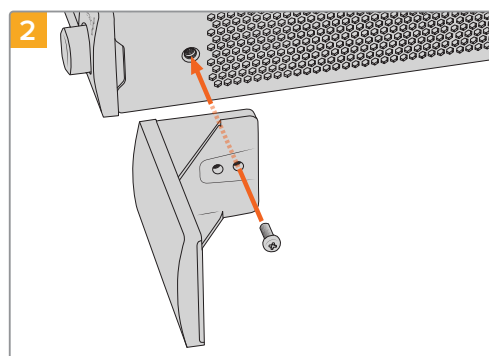

Allinea il pannello di copertura e fissalo con la vite M3 9mm in nylon in dotazione

Installare il pannello di copertura da 1/3

Se installi un singolo dispositivo sul rack, il pannello di copertura da 1/3 di larghezza si può montare direttamente su uno dei lati della mensola. Per installare un pannello di copertura, allinea i fori filettati e il punto di ancoraggio alla base del pannello e fissalo alla mensola utilizzando due delle viti M3 5mm a testa svasata in dotazione.

Aggiornare il software interno

L'utilità consente di aggiornare Web Presenter e configurare le impostazioni di streaming, le impostazioni di rete e la qualità dello streaming.

Come aggiornare il software interno:

- 1 Scarica la più recente utilità Web Presenter Setup dalla pagina www.blackmagicdesign.com/it/support.
- 2 Lancia l'installer e segui le istruzioni sullo schermo.
- 3 A installazione completata, collega Web Presenter al computer tramite la porta USB sul retro o sul pannello frontale sotto lo sportellino antipolvere.
- 4 Lancia Web Presenter Setup. Se appare una finestra di aggiornamento del software interno, segui le istruzioni. Se non appare nessuna finestra, il software interno è già aggiornato.

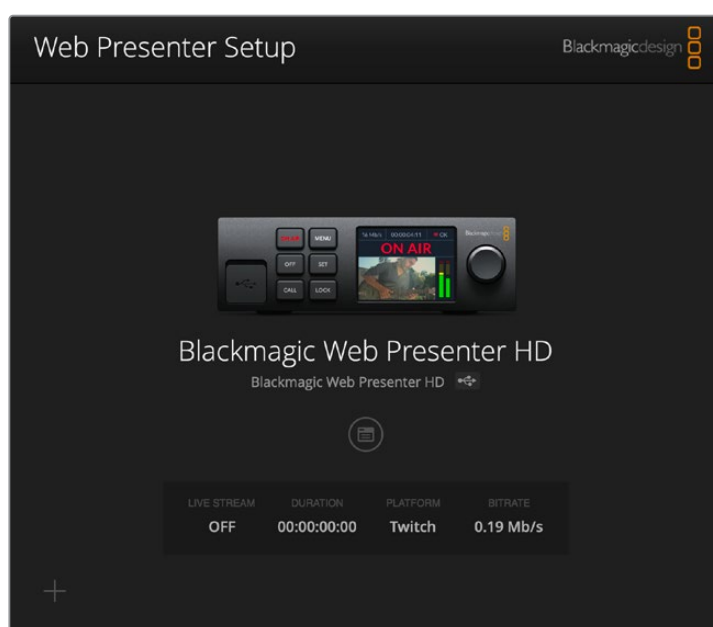

La versione più recente è disponibile per il download alla pagina Supporto di Blackmagic Design su www.blackmagicdesign.com/it/support

Developer Information

Blackmagic Web Presenter Ethernet Protocol

v1.2

Protocol Details

Overview

The Blackmagic Web Presenter Ethernet Protocol is a line-oriented, text-based protocol to control a Web Presenter.

Lines from the Web Presenter server will be separated by an ASCII LF sequence.

Messages from the user may be separated by LF or CR LF.

Connection

The Web Presenter server is accessed by connecting to TCP port 9977 on a Web Presenter.

Connection Response

Upon connection, the Web Presenter server sends a dump of the device's state.

The Web Presenter server sends information in blocks, with each having an identifying header followed by a colon. A block spans multiple lines and is terminated by a blank line. Each line in the protocol is terminated by a newline character.

Following the header, a block contains either a single multi-line string or a sequence of key/value pairs arranged one per line. The first full-colon on a line is used to delimit the key and the value. A value may be a comma separated list. In this case, values in the list must have the “,” and “\” characters escaped with a “\” character.

To be resilient to future protocol changes, clients should ignore blocks they do not recognize, up to the trailing blank line. Within recognized blocks, clients should ignore keys they do not recognize.

Legend	
↵	End of line
...	and so on
Orange Text	Client Generated
Grey Text	Server Generated

The protocol preamble block is always the first block sent by the Web Presenter server:

```
PROTOCOL PREAMBLE:↵
Version: 1.2↵
↵
```

The version field indicates the protocol version. When the protocol is changed in a compatible way, the minor version number will be updated. If incompatible changes are made, the major version number will be updated.

The initial status dump is concluded by the end prelude block:

```
END PRELUDE:↵
↵
```

Status Updates

When any device parameter is changed on the Web Presenter server by any client, such as the Blackmagic Web Presenter Setup utility, the Web Presenter server resends the applicable status block, containing only the items that have changed. Status updates can also occur due to external changes such as tethering to a smartphone or when a streaming service is disconnected.

For example, if the input video mode is set to Auto, the following block will be sent:

```
STREAM SETTINGS:↵  
Video Mode: Auto↵  
↵
```

Requesting Changes

To change one or more parameters in a block, the client should send the appropriate block header in the same form the Web Presenter server sends, followed by the key/value pairs to be changed. For example, to change the input video format to 1080p59.94, the user should send the following block:

```
STREAM SETTINGS:↵  
Video Mode: 1080p59.94↵  
↵
```

The block must be terminated by a blank line. On receipt of a blank line, the Web Presenter server will either acknowledge the request by responding:

```
ACK↵  
↵
```

or if unable to parse the block responding with:

```
NACK↵  
↵
```

After a positive response, the client should expect to see a status update from the Web Presenter server showing the status change. This is likely to be the same as the command that was sent, sometimes followed by other blocks providing data specific to the change.

```
STREAM SETTINGS:↵  
Video Mode: 1080p59.94↵  
↵
```

If the Web Presenter server does not understand a key in the requested block, the key will be ignored. If an invalid value is provided for a known key, then the request is ignored and the Web Presenter will respond with the existing value for the key. In both cases the Web Presenter server will still respond with an ACK.

```
STREAM SETTINGS:↵  
Video Mode: UnsupportedMode↵  
↵  
ACK↵  
↵  
STREAM SETTINGS:↵  
Video Mode: 1080p59.94↵  
↵
```

Requesting a Status Dump

The user may request that the Web Presenter server resend the complete state of any status block by sending the block header, followed by a blank line. In the following example, the user requests the Web Presenter server resend the stream settings:

```
STREAM SETTINGS:↵
↵
ACK↵
↵
STREAM SETTINGS:↵
Video Mode: 1080p59.94↵
...
↵
```

Protocol Blocks

Identity Block

The identity block contains information to identify the connected Web Presenter.

Block Syntax

The following example shows the Identity Block for a Blackmagic Web Presenter HD.

```
IDENTITY:↵
Model: Blackmagic Web Presenter HD↵
Label: Blackmagic Web Presenter HD↵
Unique ID: 00112233445566778899AABBCCDDEEFF↵
↵
```

Parameters

Key	Read/Write	Description	Valid Values
Model	Read only	The Web Presenter model name	String
Label	Read/Write	A display name for the Web Presenter	String
Unique ID	Read only	A device specific unique identifier	Hexadecimal ID

Changing Device Label

A device label to identify the Web Presenter can be changed by sending an identity block with label key.

```
IDENTITY:↵
Label: My Web Presenter↵
↵
ACK↵
↵
IDENTITY:↵
Label: My Web Presenter↵
↵
```

Version Block

The version block contains hardware and software version information for the connected Web Presenter.

Block Syntax

```
VERSION:↵  
Product ID: BE73↵  
Hardware Version: 0100↵  
Software Version: 0123ABCD↵  
Software Release: 3.3↵  
↵
```

Parameters

Key	Read/Write	Description	Valid Values
Product ID	Read only	The Web Presenter product ID	Hexadecimal ID
Hardware Version	Read only	The Web Presenter hardware version	Hexadecimal version
Software Version	Read only	The Web Presenter software version	Hexadecimal version
Software Release	Read only	The Web Presenter software release version	Version Number

Network Blocks

The network block contains the TCP/IP networking configuration for the connected Web Presenter.

Block Syntax

This example shows the output for a connected Web Presenter. It displays 2 networking interfaces - the Gigabit Ethernet interface and option for a tethered smartphone.

The network settings prefixed with Current show the active TCP/IP settings, and are read-only. The Current settings reflect either the DHCP or Static configuration, depending on the Dynamic IP flag.

```
NETWORK:↵  
Interface Count: 2↵  
Default Interface: 0↵  
↵  
NETWORK INTERFACE 0:↵  
Name: Ethernet↵  
Priority: 1↵  
MAC Address: 00:11:22:33:44:55↵  
Dynamic IP: true↵  
Current Addresses: 192.168.1.10/255.255.255.0↵  
Current Gateway: 192.168.1.1↵  
Current DNS Servers: 192.168.1.1, 8.8.8.8, 8.8.4.4↵  
Static Addresses: 10.0.0.2/255.255.255.0↵  
Static Gateway: 10.0.0.1↵  
Static DNS Servers: 8.8.8.8, 8.8.4.4↵  
↵
```

```

NETWORK INTERFACE 1:↵
Name: USBEthernet↵
Priority: 0↵
MAC Address: 00:00:00:00:00:00↵
Dynamic IP: true↵
Current Addresses: 0.0.0.0/255.255.0.0↵
Current Gateway: 0.0.0.0↵
Current DNS Servers: ↵
Static Addresses: 10.0.0.2/255.255.255.0↵
Static Gateway: 10.0.0.1↵
Static DNS Servers: 8.8.8.8, 8.8.4.4↵
↵

```

Parameters

Network Block

Key	Read/Write	Description	Valid Values
Interface Count	Read only	The number of networking interfaces supported by the Web Presenter	Integer
Default Interface	Read only	The default networking interface	Integer

Network Interface Block

Key	Read/Write	Description	Valid Values
Name	Read only	The name of the networking interface	String
Priority	Read/Write	The priority of the network interface. When multiple network interfaces are available, the high priority interface will become the default	Unsigned integer. The higher number is the higher priority
MAC Address	Read Only	MAC address of the networking interface	IEEE 802 MAC address
Dynamic IP	Read/Write	Selects DHCP or Static IP configuration	true - DHCP enabled false - Static IP
Current Addresses	Read Only	The current IP address and Subnet mask	{IPv4 address}/{Subnet Mask}
Current Gateway	Read Only	The current IP gateway address	IPv4 address
Current DNS Servers	Read only	The IP addresses of the current DNS servers	Comma separated list of IPv4 addresses
Static Addresses	Read/Write	Status IP address and subnet mask when DHCP disabled	{IPv4 address}/{Subnet Mask}
Static Gateway	Read/Write	Static gateway address when DHCP disabled	IPv4 address
Static DNS Servers	Read/Write	The IP addresses of the static DNS servers	Comma separated list of IPv4 addresses

Changing Networking Settings

The network can be configured to use either DHCP or a static configuration. To enable DHCP on Network Interface 0:

```
NETWORK INTERFACE 0:↵  
Dynamic IP: true↵  
↵  
ACK↵  
↵  
NETWORK INTERFACE 0:↵  
Dynamic IP: true↵  
↵
```

To set a fixed IP address, supply all static parameters:

```
NETWORK INTERFACE 0:↵  
Dynamic IP: false↵  
Static Addresses: 192.168.1.2/255.255.255.0↵  
Static Gateway: 192.168.1.1↵  
Static DNS Servers: 8.8.8.8, 8.8.4.4↵  
↵  
ACK↵  
↵  
NETWORK INTERFACE 0:↵  
Dynamic IP: false↵  
Static Addresses: 192.168.1.2/255.255.255.0↵  
Static Gateway: 192.168.1.1↵  
Static DNS Servers: 8.8.8.8, 8.8.4.4↵  
↵
```

Changing network settings may cause the IP connection to be dropped.

UI Settings Block

The UI settings block contains the front panel LCD and monitor output settings for the connected Web Presenter.

Block Syntax

```
UI SETTINGS:↵  
Available Locales: en_US.UTF-8, zh_CN.UTF-8, ja_JP.UTF-8, ko_KR.UTF-8, es_↵  
ES.UTF-8, de_DE.UTF-8, fr_FR.UTF-8, ru_RU.UTF-8, it_IT.UTF-8, pt_BR.UTF-8,↵  
tr_TR.UTF-8, pl_PL.UTF-8, uk_UA.UTF-8↵  
Current Locale: en_US.UTF-8↵  
Available Audio Meters: PPM -18dB, PPM -20dB, VU -18dB, VU -20dB↵  
Current Audio Meter: PPM -20dB↵  
↵
```

Parameters

Key	Read/Write	Description	Valid Values
Available Locales	Read only	The locales available in the Web Presenter	Comma separated list of locales
Current Locale	Read/Write	The current locale for Web Presenter	Refer to the locales from the Available Locales field
Available Audio Meters	Read only	The available audio meters supported by the Web Presenter	Comma separated list of audio meter types
Current Audio Meter	Read/Write	The current audio meter	Refer to the audio meters from the Available Audio Meters field

Stream Settings Block

The stream settings block contains the stream configuration for the connected Web Presenter.

Block syntax

This example shows the output for a connected Web Presenter. The stream settings prefixed with Current show the active stream settings and are writable. The stream settings prefixed by Available show the available stream settings for the device or platform and are read-only. To view the available servers or quality levels for a stream service, the Current Platform stream setting should be set first.

```
STREAM SETTINGS:↵
Available Video Modes: Auto, 1080p23.98, 1080p24, 1080p25, 1080p29.97,
1080p30, 1080p50, 1080p59.94, 1080p60, 720p25, 720p30, 720p50, 720p60↵
Video Mode: 1080p59.94↵
Current Platform: YouTube↵
Current Server: Primary↵
Current Quality Level: Streaming Medium↵
Stream Key: abc1-def2-ghi3-jkl4-mno5↵
Password: ↵
Current URL: srt://192.168.8.51
Customizable URL: true
Available Default Platforms: YouTube RTMP, YouTube SRT (Beta), Facebook,
Twitch, Twitter, Restream.IO, Vimeo, BoxCast, CastR, AfreecaTV, Bilibili,
DouYu, Weibo↵
Available Custom Platforms: My Platform↵
Available Servers: Primary, Secondary↵
Available Quality Levels: HyperDeck High, HyperDeck Medium, HyperDeck Low,
Streaming High, Streaming Medium, Streaming Low↵
↵
```

Parameters

Key	Read/Write	Description	Valid Values
Available Video Modes	Read only	The video modes available in the Web Presenter	Comma separated list of video modes
Video Mode	Read/Write	The current video mode	Refer to the video modes from the <i>Available Video Modes</i> field
Current Platform	Read/Write	The selected streaming platform	Refer to the platforms from the <i>Available Default Platforms</i> and <i>Available Custom Platforms</i> fields
Current Server	Read/Write	The current server for the streaming platform	Server is dependent on selected Current Platform
Current Quality Level	Read/Write	The current streaming quality level	Quality level is dependent on selected Current Platform
Stream Key	Read/Write	The stream key for the streaming platform	String
Password	Read/Write	The passphrase for an encrypted SRT stream	String
Current URL	Read/Write	The current URL for the streaming platform. This field is writable if <i>Customizable URL</i> field is true.	String
Customizable URL	Read only	A boolean specifying whether custom URLs are supported by the streaming platform	true - Custom URLs are supported false - Custom URLs are not supported
Available Default Platforms	Read only	The available default streaming platforms	Comma separated list of default platforms
Available Custom Platforms	Read only	The custom streaming platforms loaded in the Web Presenter	Comma separated list of custom platforms
Available Servers	Read only	The available servers for the selected streaming platform	Comma separated list of servers
Available Quality Levels	Read only	The available quality levels for the selected streaming platform	Comma separated list of quality levels

Changing Stream Settings

The stream settings can be changed by providing a stream settings block. The following is an example of streaming a 1080p59.94 input on Twitch with a medium stream quality.

```

STREAM SETTINGS:↵
Video Mode: 1080p59.94↵
Current Platform: Twitch↵
Current Server: US West: Los Angeles, CA↵
Current Quality Level: Streaming Medium↵
Stream Key: live_123456789_1aB2cD3eF4gH5iJ6kL7mN8oP9qR0sT↵
↵
ACK↵
↵
STREAM SETTINGS:↵
Video Mode: 1080p59.94↵
Current Platform: Twitch↵
Current Server: US West: Los Angeles, CA↵
Current Quality Level: Streaming Medium↵
Stream Key: live_123456789_1aB2cD3eF4gH5iJ6kL7mN8oP9qR0sT↵
↵

```

Stream XML Block

The stream XML block allows users to configure the Web Presenter with a custom configuration file in XML format.

Block syntax

The following example shows an XML file - Custom.xml has been loaded to configure the stream settings in the Web Presenter.

```
STREAM XML:↵  
Files: Custom.xml↵  
↵
```

Parameters

Key	Read/Write	Description	Valid Values
Files	Read/Write	The XML files loaded in Web Presenter	Comma separated list of filenames
Action	Write only	The stream XML action	Remove Remove All

Adding a Stream XML file

An XML file can be loaded onto a Web Presenter by sending the stream xml command with a filename, then provide the contents of the XML file. After adding the XML file, the Available Custom Platforms field in the STREAM SETTINGS block will be updated with the new platforms, however the Current items will remain unchanged.

For the Stream XML block to be parsed correctly, any blank lines should be removed from the XML files.

Refer to the `Blackmagic Stream XML File Format` section in this manual for description of the Stream XML file format.

```
STREAM XML Custom.xml:↵  
<?xml version="1.0" encoding="UTF-8"?>↵  
<streaming>↵  
    <service>↵  
        <name>My Custom Platform</name>↵  
        ...  
    </service>↵  
</streaming>↵  
↵  
ACK↵  
↵  
STREAM XML Custom.xml:↵  
<?xml version="1.0" encoding="UTF-8"?>↵  
<streaming>↵  
    <service>↵  
        <name>My Custom Platform</name>↵  
        ...  
    </service>↵  
</streaming>↵  
↵
```

```
STREAM XML:↵
Files: Custom.xml↵
↵
STREAM SETTINGS:↵
Available Custom Platforms: My Custom Platform↵
↵
```

Removing a Stream XML file

An XML file can be removed from the Web Presenter by sending the stream xml command with the remove action.

```
STREAM XML:↵
Action: Remove↵
Files: Custom.xml↵
↵
ACK↵
↵
STREAM XML:↵
Files:↵
↵
STREAM SETTINGS:↵
Available Custom Platforms:↵
↵
```

Removing all Stream XML files

All XML files can be removed from the Web Presenter by sending the stream xml command with the remove all action. In the example, following the remove all action, the loaded stream XML files and available custom platforms are both displayed as empty.

```
STREAM XML:↵
Action: Remove All↵
↵
ACK↵
↵
STREAM XML:↵
Files: ↵
↵
STREAM SETTINGS:↵
Available Custom Platforms:↵
↵
```

Stream State Block

The stream state block provides the streaming status of the Web Presenter.

The Web Presenter server will send a stream state block update whenever there is a change to the Status field. Due to frequency of changes to Duration, Bitrate and Cache Used fields, these fields need to be polled by the client by requesting a Stream State block.

Block syntax

```
STREAM STATE:↵↵
Status: Idle↵↵
Bitrate: 161672↵↵
Duration: 00:00:00:00↵↵
Cache Used: 0↵↵
↵↵
```

Parameters

Key	Read/Write	Description	Valid Values
Status	Read only	The stream state of the Web Presenter, updated when the stream status changes	Idle Connecting Streaming Interrupted
Action	Write only	The Web Presenter stream state action.	Start Stop
Duration	Read only	The duration of the active stream	String in format of DD:HH:MM:SS
Bitrate	Read only	The bitrate of the active stream	Integer bits per second
Cache Used	Read only	The current usage of the streaming cache	Integer as a percentage

Starting Stream

The stream is started by providing a stream state block with start action.

```
STREAM STATE:↵↵
Action: Start↵↵
↵↵
ACK↵↵
↵↵
STREAM STATE:↵↵
Status: Connecting↵↵
↵↵
STREAM STATE:↵↵
Status: Streaming↵↵
↵↵
```

Stopping stream

The stream is stopped by providing a Stream State block with stop action.

```
STREAM STATE:↵↵
Action: Stop↵
↵
ACK↵
↵
STREAM STATE:↵↵
Status: Idle↵
↵
```

Audio Settings Block

The Audio Settings block contains the audio configuration for the connected Web Presenter.

Block syntax

This example shows the output for a connected Web Presenter. The stream settings prefixed with Current show the active audio settings and are writable. The stream settings prefixed by Available show the available audio settings for the device or platform and are read-only.

```
AUDIO SETTINGS:↵↵
Current Monitor Out Audio Source: Auto↵
Available Monitor Out Audio Sources: Auto, SDI In, Remote Source↵
↵
```

Parameters

Key	Read/Write	Description	Valid Values
Current Monitor Out Audio Source	Read/Write	The current audio source on the monitor output	Refer to the audio sources from the <i>Available Monitor Out Audio Sources</i> field
Available Monitor Out Audio Sources	Read only	The available audio sources that can be routed to the monitor output	Comma separated list of audio sources

Changing Audio Settings

The audio settings can be changed by providing a audio settings block. The following is an example of setting the monitor output audio source to remote.

```
AUDIO SETTINGS:↵↵
Current Monitor Out Audio Source: Remote Source↵
↵
ACK↵
↵
AUDIO SETTINGS:↵↵
Current Monitor Out Audio Source: Remote Source↵
↵
```

Shutdown Block

The Shutdown block provides power control of the Web Presenter. The Shutdown block is write-only and not presented in the preamble.

Parameters

Key	Read/Write	Description	Valid Values
Action	Write only	The Web Presenter shutdown action.	Reboot Factory Reset

Reboot

The Web Presenter can be rebooted by providing a Shutdown block with reboot action.

```
SHUTDOWN:↵
```

```
Action: Reboot↵
```

```
↵
```

```
ACK↵
```

```
↵
```

On reboot action, the Web Presenter server will be stopped and clients will be disconnected.

Factory Reset

The Web Presenter can be factory reset by providing a Shutdown block with factory reset action. On factory reset action, all settings are set to factory defaults.

```
SHUTDOWN:↵
```

```
Action: Factory Reset↵
```

```
↵
```

```
ACK↵
```

```
↵
```

Blackmagic Streaming XML Format

Overview

The Blackmagic Streaming XML allows users to specify streaming services in addition to the default services provided by the Web Presenter.

The Streaming XML can be loaded into the Web Presenter with Web Presenter Setup. Refer to the 'Using Web Presenter Setup' section earlier in this manual

The Streaming XML can also be loaded by copying the contents into the Stream XML block with the Blackmagic Web Presenter Ethernet Protocol.

The following is a minimal example of a Streaming XML file:

```
<?xml version="1.0" encoding="UTF-8"?>
<streaming>
  <service>
    <name>My Streaming Service</name>
    <servers>
      <server>
        <name>My Streaming Server</name>
        <url>rtmp://my.streaming-server.com/live</url>
      </server>
    </servers>
    <profiles>
      <profile>
        <name>My Streaming Quality</name>
        <config resolution="1080p" fps="60" codec="H264">
          <bitrate>7500000</bitrate>
        </config>
      </profile>
    </profiles>
  </service>
</streaming>
```

Streaming XML Definition

The Streaming XML file follows standard XML format and shall begin with XML declaration.

```
<?xml version="1.0" encoding="UTF-8"?>
```

Streaming Element

The Streaming XML file shall be contained by the <streaming> element. The <streaming> element will consist of 1 or more <service> child elements.

The following is an example of a <streaming> element block that defines 2 streaming services.

```
<streaming>
  <service>
    <name>Service 1</name>
    <!-- Streaming settings for "Service 1" -->
  </service>
  <service>
    <name>Service 2</name>
    <!-- Streaming settings for "Service 2" -->
  </service>
</streaming>
```

Service Element

The <service> element provides a description of the streaming service. If multiple streaming services are used, it is possible to define multiple <service> elements within each <streaming> element block.

The following is an example of a <service> element block in the Stream XML file.

```
<streaming>
  <service customizable-url="true">
    <name>My Streaming Service</name>
    <key>abc1-def2-ghi3-jkl4-mno5</key>
    <servers>
      <!-- Streaming server settings -->
    </servers>
    <profiles default="Streaming High">
      <!-- Streaming quality settings-->
    </profiles>
    <credentials>
      <!-- Streaming username and password settings -->
    </credentials>
  </service>
  <!-- <service> elements blocks for other streaming services -->
</streaming>
```

Attributes

Attribute	Optional/Required	Description
customizable-url	Optional	The service supports specifying custom URLs - supported = "true" or unsupported = "false" (default)

Child Elements

Element	Optional/Required	Description
<name>	Required	The name of the streaming service
<key>	Optional	The stream key for the streaming service
<servers>	Optional	The RTMP/SRT server settings of the streaming service (see below). May be omitted if customizable-url is true.
<profiles>	Required	The quality settings of the streaming service (see below)
<credentials>	Optional	The username and password of the streaming service (see below)

Servers Element

The <servers> element consists of 1 or more <server> child elements for defining the streaming server(s). The <servers> element is a required child of the <service> element. Defining multiple servers allows specifying localized and/or backup servers within a single XML description

The following is an example of a <servers> element block that defines a primary and secondary URL for the SRT server.

```
<service>
  ...
  <servers>
    <server group="Primary">
      <name>My Streaming Service Server</name>
      <url>srt://srt.my-streaming-service.com:2010</url>
      <srt-extensions>
        ...
      </srt-extensions>
    </server>
    <server group="Secondary">
      <name>My Streaming Service Backup Server</name>
      <url>srt://srt-backup.my-streaming-service.com:2010</url>
      <srt-extensions>
        ...
      </srt-extensions>
    </server>
    <!-- Additional <server> element blocks defining other
servers for streaming service -->
  </servers>
  ...
</service>
```

Attributes

Attribute	Optional/Required	Description
group	Optional	The logical grouping for the server

Child Elements

Element	Optional/Required	Description
<name>	Required	The name of the RTMP/SRT streaming server
<url>	Required	The URL of the RTMP/SRT streaming server
<srt-extensions>	Optional	Extended service block specific to SRT streaming server (see below)

SRT Extensions Element

The <srt-extensions> element consists of 1 or more child elements that define SRT specific parameters.

The following is an example of a <srt-extensions> element block for a primary stream identifier.

```
<service>
  ...
  <servers>
    <server group="Primary">
      ...
      <srt-extensions>
        <stream-id>
          <item key="copy" value="0"/>
        </stream-id>
      </srt-extensions>
    </server>
  </servers>
  ...
</service>
```

Child Elements

Element	Optional/Required	Description
<stream-id>	Required	Provides element with custom parameters for the stream ID. Each child element of stream-id has 1 or more item elements with a key/value pair.

Profiles Element

The <profiles> element consists of 1 or more <profile> child elements that define streaming quality. The <profiles> element is a required child of the <service> element. Defining multiple profiles allows specifying custom bitrates for different streaming qualities.

The following is an example of a <profiles> element block that defines 3 profiles.

```
<service>
  ...
  <profiles default="Streaming High">
    <profile>
      <name>Streaming High</name>
      <!-- Define <config> elements to specify target
bitrates for Streaming High profile -->
    </profile>
    <profile>
      <name>Streaming Medium</name>
      <!-- Define <config> elements to specify target
bitrates for Streaming Medium profile -->
    </profile>
  </profiles>
  ...
</service>
```

Attributes

Attribute	Optional/Required	Description
default	Optional	The name of the default profile

Child Elements

Element	Optional/Required	Description
<name>	Required	The name of the profile
<config>	Required	Video mode dependent quality settings for profile (see below)

Config Element

The <config> element defines a mapping between the video resolution and frame rate and the target bitrate for the quality level. The <config> element is a child of the <profile> element.

The following is an example of a <config> element block for setting the target bitrate for a high quality stream with 720p60 and 1080p60 video inputs.

```
<profile>
  <name>Streaming High</name>
  <config resolution="720p" fps="60" codec="H264">
    <bitrate>6000000</bitrate>
    <audio-bitrate>128000</audio-bitrate>
  </config>
  <config resolution="1080p" fps="60" codec="H264">
    <bitrate>8000000</bitrate>
    <audio-bitrate>128000</audio-bitrate>
  </config>
  <!-- <config> elements for other resolutions and frame rates -->
</profile>
```

Attributes

Attribute	Optional/Required	Description
resolution	Required	The resolution of the streaming video mode
fps	Required	The frame rate of the streaming video mode (frames per second)
codec	Optional	The codec for encoding the streaming video - "H264" (default) or "H265"

Child Elements

Element	Optional/Required	Description
<bitrate>	Required	The target bitrate of the streaming video (bits per second)
<audio-bitrate>	Optional	The target bitrate of the streaming audio (bits per second)

The supported streaming quality bitrates can be found in section `Using Web Presenter Setup` section earlier in this manual.

TIP For each <config> element block, choose a maximum resolution and fps to cover all video modes for the target bitrate. For example, defining a <config> element with resolution="1080p" and fps = "30" will apply for video modes 1080p23.98, 1080p24, 1080p25, 1080p29.97 and 1080p30.

For audio bitrate, only 128 Kb/s is supported.

Credentials Element

The <credentials> element allows specifying an RTMP session username and password if required by the service. The <credentials> element is an optional child to service element.

The following is an example of a <credentials> element block that defines a username and password for the streaming service.

```
<service>
  ...
  <credentials>
    <username>myusername</username>
    <password>abcd1234</password>
  </credentials>
  ...
</service>
```

Child Elements

Element	Optional/Required	Description
<username>	Required	RTMP session username
<password>	Required	RTMP/SRT session password

Assistenza clienti

Assistenza

Il modo più veloce di ottenere assistenza è visitare la pagina Supporto sul sito Blackmagic Design, dove trovi il materiale di supporto più recente per il tuo Web Presenter.

Pagina di supporto online

La versione più recente del manuale è disponibile alla pagina www.blackmagicdesign.com/it/support

Blackmagic Forum

Il Blackmagic Forum sul nostro sito è un'ottima risorsa per ottenere informazioni utili e condividere idee creative. Qui trovi le risposte alle domande più frequenti, oltre ai consigli forniti da utenti esperti e dal team Blackmagic Design. Visita il Forum alla pagina <https://forum.blackmagicdesign.com>

Contattare Blackmagic Design

Se il materiale sulla nostra pagina Forum non risponde alle tue domande, clicca su **Invia una email** nella pagina Supporto, oppure clicca su **Trova un team di supporto** per contattare direttamente il team di Blackmagic Design più vicino a te.

Normative



Smaltimento di apparecchiature elettriche ed elettroniche nell'Unione Europea

Questo simbolo indica che il prodotto non deve essere scartato insieme agli altri rifiuti, ma consegnato a uno degli appositi centri di raccolta e riciclaggio. La raccolta e lo smaltimento differenziato corretto di questo tipo di apparecchiatura evita lo spreco di risorse e contribuisce alla sostenibilità ambientale e umana. Per tutte le informazioni sui centri di raccolta e riciclaggio, contatta gli uffici del tuo comune di residenza o il punto vendita presso cui hai acquistato il prodotto.



Questo dispositivo è stato testato e dichiarato conforme ai limiti relativi ai dispositivi digitali di Classe A, ai sensi dell'articolo 15 del regolamento FCC. Tali limiti sono stati stabiliti con lo scopo di fornire protezione ragionevole da interferenze dannose in ambienti commerciali. Questo dispositivo genera, usa e può irradiare energia a radiofrequenza e, se non è installato o usato in conformità alle istruzioni, può causare interferenze dannose che compromettono le comunicazioni radio. Operare questo dispositivo in ambienti residenziali può causare interferenze dannose, nella cui evenienza l'utente dovrà porvi rimedio a proprie spese.

Il funzionamento è soggetto alle due condizioni seguenti:

- 1 Questo dispositivo non deve causare interferenze dannose.
- 2 Questo dispositivo deve accettare eventuali interferenze ricevute, incluse le interferenze che possono causare un funzionamento indesiderato.



R-R-BMD-20201201001
R-R-BMD-20201201002

Dichiarazione ISED (Canada)

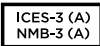

Questo dispositivo è conforme agli standard canadesi sui dispositivi digitali di Classe A.

Qualsiasi modifica o utilizzo del dispositivo al di fuori di quello previsto potrebbero invalidare la conformità a tali standard.

Consigliamo di connettere le interfacce HDMI usando cavi schermati HDMI di alta qualità.

Questo dispositivo è stato testato per l'uso in ambienti commerciali. Se utilizzato in ambienti domestici, può causare interferenze radio.

Sicurezza

Questo dispositivo deve essere connesso a una presa di corrente con messa a terra.

Per ridurre il rischio di scosse elettriche, evitare di esporre il dispositivo a gocce o spruzzi.

Questo dispositivo è adatto all'uso nei luoghi tropicali con una temperatura ambiente non superiore ai 40°C.

La temperatura di stoccaggio va da -20° a 60°C e l'umidità relativa da 0% a 90% senza condensazione.

Lasciare uno spazio adeguato intorno al prodotto per consentire sufficiente ventilazione.

Se il dispositivo è installato su rack, assicurarsi che i dispositivi adiacenti non ostacolino la ventilazione.

Le parti all'interno del dispositivo non sono riparabili dall'utente. Contattare il personale qualificato di un centro Blackmagic Design per le operazioni di manutenzione.

Usare il dispositivo a un'altitudine non superiore a 2000 m sopra il livello del mare.

Dichiarazione dello Stato della California

Questo dispositivo può esporre l'utente a sostanze chimiche, per esempio tracce di bifenili polibromurati nelle parti in plastica, che nello Stato della California sono considerati causa di cancro e difetti alla nascita o altri danni al sistema riproduttivo.

Per maggiori informazioni, visita la pagina www.P65Warnings.ca.gov.

Garanzia

Garanzia limitata di 36 mesi

Blackmagic Design garantisce al/la Cliente l'esenzione di Web Presenter da difetti nei materiali e nella fabbricazione per il periodo di garanzia di 36 mesi dalla data di acquisto del prodotto. Sono esclusi i connettori, i cavi, i moduli per fibra ottica, i fusibili e le batterie, forniti privi di difetti nei materiali e nella fabbricazione per un periodo limitato di 12 mesi dalla data di acquisto. Durante il periodo di garanzia, Blackmagic Design, a sua scelta, riparerà il prodotto difettoso, senza costi per le parti e la manodopera, o sostituirà il prodotto difettoso purché questo venga restituito.

Per ottenere l'assistenza coperta dalla presente garanzia, il/la Cliente deve notificare Blackmagic Design del difetto entro il periodo di garanzia e accordarsi sulla prestazione del servizio. Il/la Cliente è responsabile del costo di imballaggio e di spedizione del prodotto difettoso al centro di assistenza indicato da Blackmagic Design, con spese di spedizione prepagate. Le spese di spedizione, l'assicurazione, le tasse, la dogana e altre spese pertinenti la resa del prodotto a Blackmagic Design sono a carico del/la Cliente.

Questa garanzia perde di validità per difetti, malfunzionamento o danni causati da utilizzo improprio o da manutenzione e cura inadeguate del prodotto. Blackmagic Design non ha obbligo di fornire assistenza sotto questa garanzia: a) per riparare danni causati da tentativi di installazione, riparazione o manutenzione da parte di personale che non sia autorizzato da Blackmagic Design, b) per riparare danni causati da uso improprio o connessione ad attrezzatura incompatibile, c) per riparare danni o malfunzionamenti causati dall'uso di parti o ricambi non originali Blackmagic Design, o d) per fare manutenzione se il prodotto è stato modificato o integrato ad altri prodotti con il risultato di allungare i tempi della manutenzione o di renderla più difficoltosa. LA PRESENTE GARANZIA DI BLACKMAGIC DESIGN SOSTITUISCE QUALSIASI ALTRA GARANZIA, ESPLICITA O IMPLICITA. BLACKMAGIC DESIGN E I SUOI FORNITORI ESCLUDONO QUALSIASI ALTRA GARANZIA IMPLICITA DI COMMERCIALIZZABILITÀ O DI IDONEITÀ AD UN USO SPECIFICO. L'INTERA RESPONSABILITÀ DI BLACKMAGIC DESIGN E L'UNICO ESCLUSIVO RICORSO DELL'UTENTE PER QUALSIASI DANNO ARRECATO DI NATURA INDIRETTA, SPECIFICA, ACCIDENTALE O CONSEGUENZIALE, ANCHE QUALORA BLACKMAGIC DESIGN O UN SUO FORNITORE FOSSERO STATI AVVERTITI DELLA POSSIBILITÀ DI TALI DANNI, È LA RIPARAZIONE O LA SOSTITUZIONE DEI PRODOTTI DIFETTOSI. BLACKMAGIC DESIGN NON SI ASSUME ALCUNA RESPONSABILITÀ PER QUALSIASI USO ILLEGALE DEL DISPOSITIVO DA PARTE DEL/LA CLIENTE. BLACKMAGIC DESIGN NON SI ASSUME ALCUNA RESPONSABILITÀ PER DANNI DERIVANTI DALL'USO DI QUESTO PRODOTTO. IL/LA CLIENTE UTILIZZA QUESTO PRODOTTO A PROPRIO RISCHIO.

© Copyright 2023 Blackmagic Design. Tutti i diritti riservati. 'Blackmagic Design', 'DeckLink', 'HDLink', 'Workgroup Videohub', 'Multibridge Pro', 'Multibridge Extreme', 'Intensity' and 'Leading the creative video revolution' sono marchi registrati negli Stati Uniti e in altri Paesi. Altri nomi di prodotti e aziende qui contenuti possono essere marchi dei rispettivi proprietari.

Thunderbolt e il logo Thunderbolt sono marchi registrati di Intel Corporation negli Stati Uniti e/o altri paesi.

Blackmagic Web Presenter





Prezado Cliente,

Obrigado por adquirir um Blackmagic Web Presenter!

O Blackmagic Web Presenter é conectado diretamente a qualquer equipamento SDI, converte o sinal para H.264 e permite transmitir conteúdo em plataformas de streaming populares, como YouTube Live, Facebook Live e Twitch. Você também pode transmitir vídeos ponto a ponto com qualidade broadcast usando um ATEM Streaming Bridge opcional. Isso facilita o streaming de vídeos profissionais para locações remotas usando a internet!

Este manual de instruções inclui todas as informações necessárias para que você comece a trabalhar com o seu Blackmagic Web Presenter, aprenda a usar todos os recursos e controles, saiba como configurá-lo para trabalhar com YouTube Live, Facebook Live, Twitch, Zoom, Skype e muito mais.

Consulte a página de suporte no nosso site em www.blackmagicdesign.com/br para obter a versão mais recente deste manual e para atualizações do software interno do seu Blackmagic Web Presenter. Ao baixar o software, registre suas informações para que possamos mantê-lo atualizado quando novos programas forem lançados.

Estamos sempre trabalhando em novos recursos e aprimoramentos, então adoráramos ouvir a sua opinião.

Grant Petty

Diretor Executivo da Blackmagic Design

Índice

Instruções Preliminares	482
Usando o Painel Frontal do Web Presenter	485
Tela LCD	486
Usando a Saída de Monitoramento	487
Usando o Web Presenter Setup	492
Aba Live Stream	493
Aba Setup	496
Configurações de Rede	497
Configurando Compartilhamento de Internet para Streaming Direto	497
Streaming via Smartphone	498
Usando Blackmagic Web Presenter como uma Webcam	498
Configurar Open Broadcaster	498
Criando Links de Vídeo com o ATEM Streaming Bridge	501
Criando o Arquivo XML	502
Exportando o Arquivo XML	502
Sinalização, Intercomunicação e Controle de Câmera	503
Conectando a URSA Broadcast G2	504
Blackmagic Universal Rack Shelf	505
Conteúdo	505
Montar a Unidade no Rack	506
Encaixar a Frente Falsa de 1/6	506
Encaixar a Frente Falsa de 1/3	506
Atualizando o Software Interno	507
Developer Information	508
Blackmagic Web Presenter Ethernet Protocol	508
Blackmagic Streaming XML Format	521
Overview	521
Streaming XML Definition	521
Ajuda	528
Informações Regulatórias	529
Informações de Segurança	530
Garantia	531

Instruções Preliminares

Começar a utilizar o seu Blackmagic Web Presenter é rápido e fácil! Tudo que você precisa fazer é conectar a alimentação, conectar vídeo e áudio, conectar a unidade ao seu computador e conectar à internet.

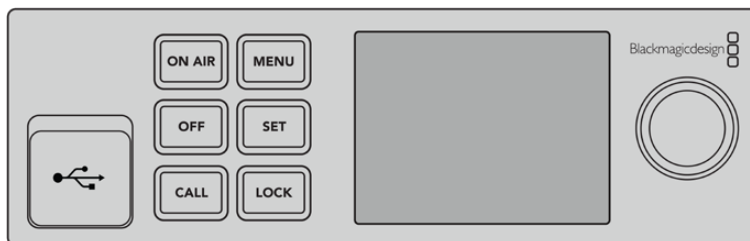

Painel frontal do Blackmagic Web Presenter.

Conectando Alimentação

Conecte um cabo de alimentação IEC padrão à entrada de alimentação no painel traseiro do seu Blackmagic Web Presenter.

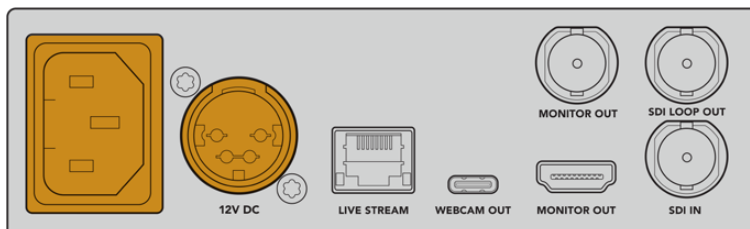

O Blackmagic Web Presenter pode ser alimentado através de uma entrada de alimentação IEC ou DC 12 V.

O Web Presenter também possui uma entrada de alimentação DC 12 V adicional. Você pode usar essa entrada caso queira conectar alimentação externa ou redundante através de uma fonte de alimentação externa, por exemplo, uma UPS ou uma bateria de 12 V externa.

Conectando Vídeo e Áudio

Conecte seu vídeo de origem à entrada SDI do Blackmagic Web Presenter. Quando conectado, o vídeo será exibido na tela LCD integrada do seu Web Presenter. O áudio é integrado ao vídeo no sinal de vídeo SDI e você pode confirmar isso observando os medidores de áudio na tela LCD.

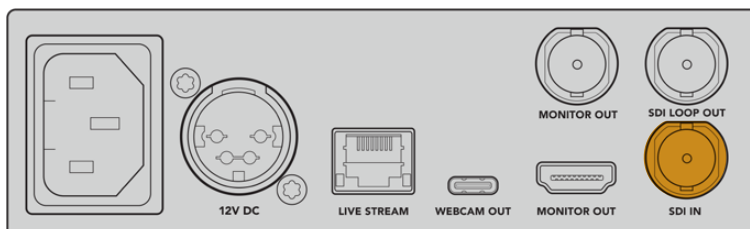

Conecte o vídeo à entrada SDI do seu Blackmagic Web Presenter.

O Blackmagic Web Presenter suporta 12G-SDI e alternará automaticamente entre HD e Ultra HD até 2160p60 quando a entrada de vídeo for alterada. O modelo Blackmagic Web Presenter 4K pode transmitir em Ultra HD, enquanto que o Blackmagic Web Presenter HD pode receber praticamente qualquer sinal de vídeo e convertê-lo para 1080p.

Conectando um Monitor

Plugue um televisor HDMI ou um monitor SDI em uma das saídas de monitoramento. Isso permite monitorar a transmissão e observar informações de status importantes que são atualizadas constantemente com o seu fluxo de vídeo. Para mais informações sobre como usar a saída de monitoramento, consulte a seção 'Usando a Saída de Monitoramento'.

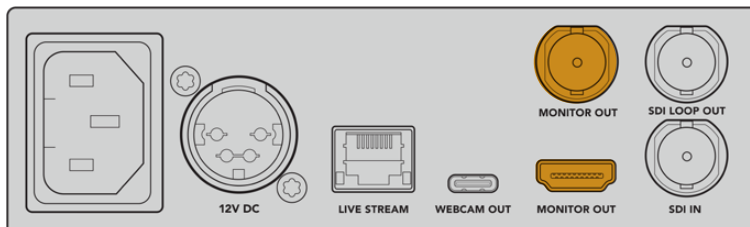

Conecte um monitor à saída de monitoramento do seu Web Presenter.

Conectando a um Computador via USB

Conecte o seu Web Presenter ao seu computador usando a porta USB-C no painel frontal ou traseiro. Essas portas USB são usadas para atualizar a unidade e configurá-la com o Blackmagic Web Presenter Setup Utility. Após configurar o seu Web Presenter pela primeira vez, você pode desconectar a unidade do seu computador.

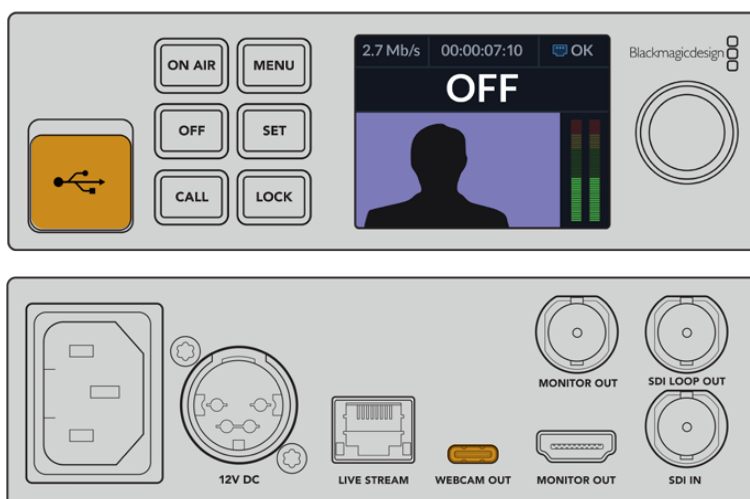

Conecte o Blackmagic Web Presenter ao seu computador usando a porta USB no painel frontal ou traseiro.

Conectando à Internet

Conecte seu Blackmagic Web Presenter à internet plugando um cabo de rede da porta Ethernet rotulada "Live Stream" a um roteador de internet ou uma rede Ethernet.

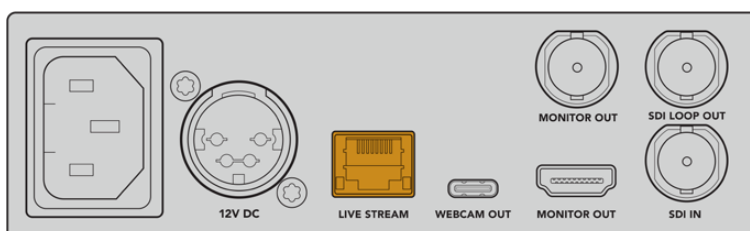

Conecte o Blackmagic Web Presenter à sua rede através da porta Ethernet no painel traseiro.

Configurando um Streaming ao Vivo

Agora você pode configurar seu Web Presenter para transmitir usando qualquer plataforma de streaming, como YouTube Live, Facebook Live, Twitch entre outras. Neste exemplo, vamos configurar uma transmissão ao vivo no YouTube Live.

- 1 Copie a sua chave de transmissão da sua conta no YouTube Studio.
- 2 Baixe o Blackmagic Web Presenter Setup Utility em www.blackmagicdesign.com/br/support e instale-o no seu computador. Nele você pode ajustar as configurações da transmissão pela primeira vez.
- 3 Inicie o utilitário Blackmagic Web Presenter Setup e vá até a página “Live Stream”.
- 4 Configure a plataforma para YouTube e o servidor para “Primary”. Cole a chave de transmissão no campo “Key” e selecione a qualidade da transmissão. Clique em “Save”.
- 5 Agora você está pronto para começar a transmitir para o mundo! Clique no botão “On Air” ou pressione o botão “On Air” no painel frontal da unidade. Quando sua transmissão terminar, pressione o botão “Off” para encerrá-la.

Usando o Protocolo de Streaming SRT

O protocolo de transporte seguro e confiável, ou SRT, oferece transmissões com latência mais baixa em comparação ao RTMP. O SRT também aumenta a segurança ao usar uma frase de acesso, semelhante a uma chave de criptografia.

Ao selecionar a versão do protocolo SRT no seu serviço de streaming, copie a frase de acesso e a chave de transmissão da sua conta na plataforma de streaming e cole-as nos campos “Key” e “Passphrase” do utilitário Blackmagic Web Presenter Setup.

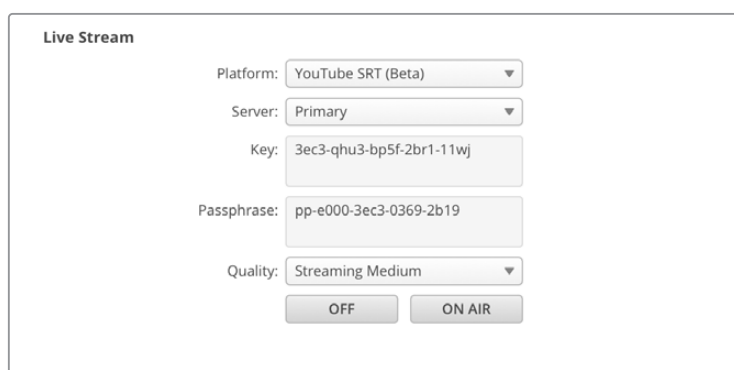

Live Stream

Platform: YouTube SRT (Beta) ▼

Server: Primary ▼

Key: 3ec3-qhu3-bp5f-2br1-11wj

Passphrase: pp-e000-3ec3-0369-2b19

Quality: Streaming Medium ▼

OFF ON AIR

Cole sua frase de acesso no campo “Passphrase” do utilitário de configuração.

Tanto o protocolo RTMP ou SRT quanto o codec H.264 ou H.265 podem ser alterados no arquivo XML, caso profissionais de transmissão com conhecimento técnico desejem personalizar as configurações da transmissão. Para mais informações, consulte a seção “Formato XML de Transmissão da Blackmagic”.

Usando o Painel Frontal do Web Presenter

Use os controles do painel frontal do Blackmagic Web Presenter para iniciar e interromper o streaming e para alterar as configurações.

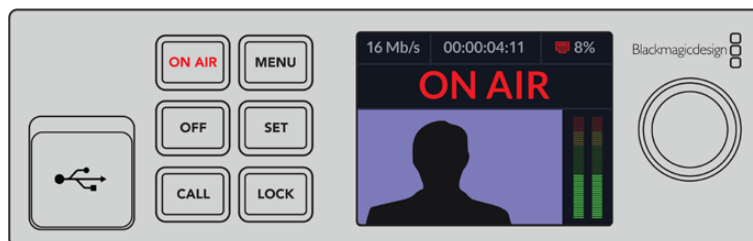

On Air - Para iniciar um streaming, basta pressionar o botão "On Air". O botão acenderá em vermelho enquanto o streaming estiver no ar.



Caso ocorra uma interrupção inesperada durante o streaming ao vivo, o botão "On Air" começará a piscar. Isso pode acontecer por conta de um problema com a sua conexão de internet ou com a configuração de streaming. Verifique se a sua conexão de internet está funcionando e se as configurações de streaming estão corretas.

Off - Para interromper o streaming, pressione o botão "Off".

Menu - Pressione o botão "Menu" para acessar as configurações na tela de LCD.

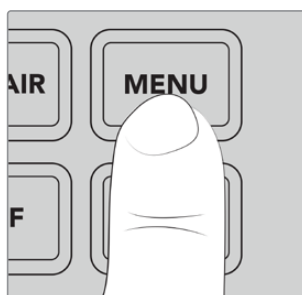

Como alterar as configurações:

- 1 Gire o knob para selecionar a configuração que você deseja alterar e pressione "Set".



- 2 Gire o knob para alterar a sua configuração.
- 3 Pressione "Set" novamente para confirmar a alteração da configuração.

Pressione o botão "Menu" para retornar à tela inicial.

Call - Este recurso será habilitado em uma atualização futura.

Lock - Pressione e segure este botão por 1 segundo para bloquear o painel. Isso desabilita os botões, prevenindo que alguém entre no ar ou interrompa um streaming ao vivo acidentalmente. O botão acenderá em vermelho quando ativado.

Pressione e segure por 2 segundos para desbloquear o painel.

Tela LCD

A tela inicial é o primeiro recurso que você verá quando conectar o seu Web Presenter à alimentação. A tela inicial exibe informações importantes, incluindo:

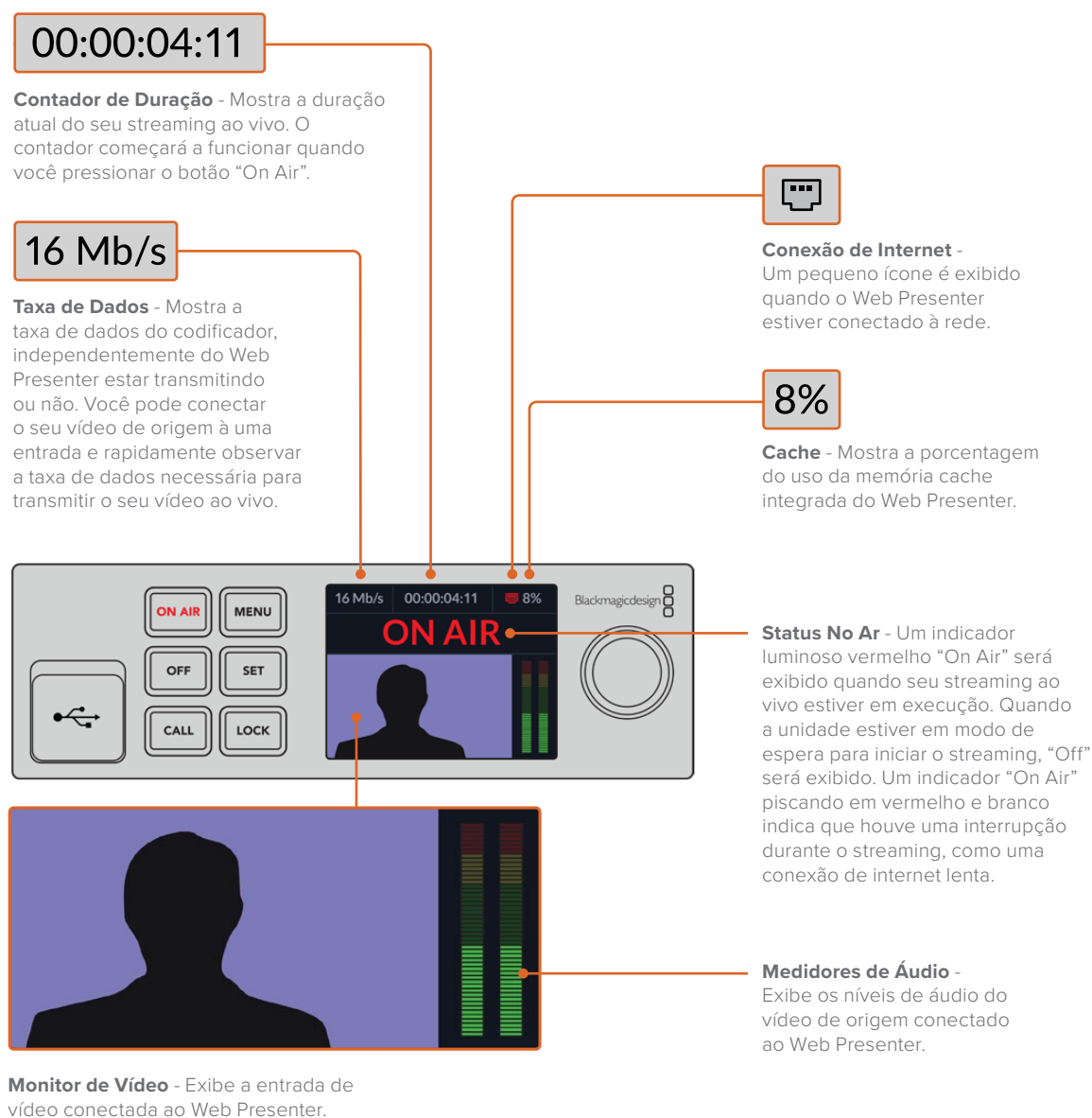

Ícones de Conexão de Internet



Um ícone de Ethernet azul será exibido quando um cabo Ethernet estiver conectado e a conexão Ethernet for usada para a transmissão.



Um ícone de Ethernet vermelho será exibido quando o streaming estiver no ar sendo transmitido via Ethernet.



Um ícone de smartphone azul será exibido quando a conexão de internet de um smartphone for usada para a transmissão.



Um ícone de smartphone vermelho será exibido quando o streaming estiver no ar sendo transmitido via conexão de um smartphone.

DICA Se nenhum ícone estiver sendo exibido, o seu Web Presenter não está conectado à rede.

Usando a Saída de Monitoramento

A saída de monitoramento permite acompanhar a entrada de vídeo, os níveis de áudio, status “On Air”, taxa de dados e níveis do cache, além de informações técnicas sobre a entrada SDI.



Na saída de monitoramento do Blackmagic Web Presenter você encontra informações detalhadas, como taxa de dados e status de cache.

O display da saída de monitoramento é composto por até oito painéis. Abaixo está uma descrição de cada painel e a informação que ele exibe.

Visualização de Entrada

O painel principal exibe a entrada de vídeo atual da fonte de vídeo SDI conectada.



Indicador On Air

Antes da transmissão, o indicador de status “On Air” exibirá “Off” para informar que o Web Presenter está em modo de espera e pronto para transmitir. Quando o streaming começar, o indicador exibirá um status “On Air” em vermelho até que o streaming seja interrompido.



Embaixo do indicador “On Air” há um contador de duração. Quando você pressionar o botão “On Air” no Web Presenter, o contador de duração começará a funcionar.

Se o seu Web Presenter não estiver no ar, mas estiver conectado para transmitir via tethering de um smartphone, o indicador “Off” incluirá um ícone de smartphone azul no canto. O ícone de smartphone será exibido em vermelho quando estiver no ar.

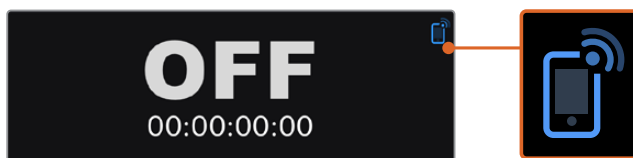

Transmissão Ao Vivo

O painel “Transmissão Ao Vivo” mostra informações sobre as configurações da sua transmissão ao vivo, incluindo a plataforma de streaming, o servidor e o protocolo. Além disso, mostra a resolução e as configurações de qualidade da transmissão.

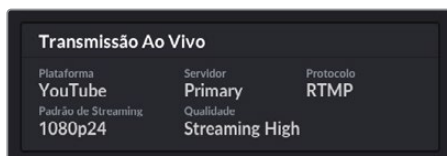

Entrada de Vídeo

Os cinco minivisualizadores da parte superior do painel de entrada de vídeo exibem os últimos seis segundos do seu streaming ao vivo. Cada minivisualizador representa 1,2 segundos de tempo de streaming.

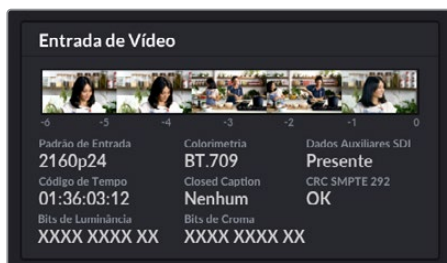

Abaixo dos minivisualizadores, você pode ver informações técnicas detalhadas sobre a entrada do vídeo de origem conectado à entrada SDI do seu Web Presenter.

Padrão de Entrada	Exibe a resolução e a taxa de quadros da entrada de vídeo SDI. O Web Presenter suporta até 2160p60.
Colorimetria	Mostra o espaço de cores da entrada de vídeo SDI. O Web Presenter suporta os espaços de cores Rec.601, Rec.709 e Rec.2020.
Dados Auxiliares SDI	Dados auxiliares são dados adicionais do vídeo transportados pela entrada de vídeo SDI. Isso inclui áudio embutido, código de tempo e audiodescrição fechada. Se sua entrada SDI incluir dados auxiliares, "Presente" será exibido.
Código de Tempo	Exibe o código de tempo da entrada de vídeo de origem SDI.
Audiodescrição Fechada	Se sua entrada de vídeo SDI incluir closed captions, o formato será exibido neste campo. São suportados os formatos CEA-608 e CEA-708.
SMPTE 292 CRC	Esta é uma função de verificação de erros para vídeo SDI. Um erro será exibido caso o seu Web Presenter detecte um problema na entrada de vídeo SDI. Os erros CRC geralmente são causados por um cabo SDI com defeito ou um cabo muito longo.
Bits de Luminância e Bits de Cromo	<p>Os indicadores de "Bits de Luminância" e "Bits de Cromo" mostram a atividade do sinal de entrada de vídeo SDI. Cada letra representa o estado de um bit do sinal de vídeo.</p> <p>"X" - indica um bit em constante mudança.</p> <p>"L" - indica um bit baixo.</p> <p>"H" - Indica um bit alto.</p> <p>Os offsets SDI são subtraídos para facilitar o entendimento. Por exemplo, todos os bits são baixos quando o vídeo está preto.</p> <p>Na maior parte do tempo, todos os 10 bits da entrada de vídeo SDI exibirão "X", indicando que todos os bits do fluxo de vídeo estão mudando constantemente. Se a sua entrada SDI for um vídeo de 8 bits, os dois bits mais à direita sempre mostrarão "L", já que não possuem nenhum dado. Se um bit mostrar "L" ou "H" quando você esperava um "X", isso indica que há um "bit preso" e pode ser o resultado de uma falha no vídeo upstream.</p>

Entrada de Áudio

A forma de onda de áudio é exibida na parte superior do painel de entrada de áudio e mostra informações de áudio dos últimos 6 segundos do seu streaming ao vivo. Ela é atualizada continuamente e rola da direita para a esquerda.

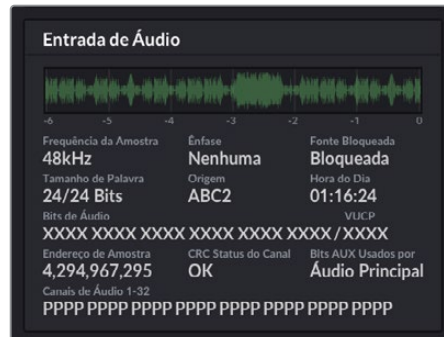

Você pode visualizar informações técnicas detalhadas sobre a entrada de áudio logo abaixo da forma de onda de áudio.

Frequência da Amostra	Exibe a taxa de frequência da amostra do áudio embutido na entrada SDI.
Ênfase	Indica se a fonte de áudio está com a opção “Ênfase” habilitada.
Fonte Bloqueada	Indica se a frequência da fonte de áudio está bloqueada para uma fonte de sincronização externa.
Tamanho de Palavra	Mostra a profundidade de bits do áudio embutido na entrada SDI.
Origem	Estes quatro caracteres indicam a origem do canal.
Hora do Dia	Código de tempo de execução livre.
Bits de Áudio	Mostra a atividade de bits das amostras de áudio embutido na conexão SDI. Mesmo se o status do canal de áudio indicar que você tem áudios de 16, 20 ou 24 bits, a atividade de bits de áudio confirmará isso.
VUCP	Lendo bits VUCP da esquerda para a direita: o bit “V” indica “Válido”; “U” é o bit “Usuário”; “C” é o bit “Status do Canal” e “P” é “Paridade”. Este campo é semelhante a “Bits de Áudio”.
Endereço de Amostra	Contador de amostra de áudio.
Bits AUX Usados por	Indica se os bits AUX estão sendo usados no áudio principal.
Canais de Áudio 1-32	Cada dígito representa um canal de áudio integrado na entrada SDI. Um “P” mostra que um canal de áudio está em uso e um “-” significa que não há áudio nesse canal.

Indicador de Taxa de Dados

O indicador de taxa de dados mostra a taxa de dados do codificador dos últimos 60 segundos. A taxa de dados é medida em megabits por segundo. Este indicador funciona de forma consistente, mesmo quando se estiver fora do ar, para que você possa medir sua largura de banda com precisão antes de entrar no ar.

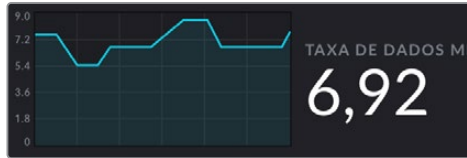

Indicador de Cache

O indicador de cache exibe a porcentagem do buffer da memória integrada ao seu Web Presenter que está em uso e o gráfico mostra a quantidade usada nos últimos 60 segundos. O cache é uma pequena quantidade de memória interna que grava e reproduz sem parar a saída de programa. Ele serve como uma medida de segurança caso a taxa de dados da transmissão atinja um nível que impossibilite que o vídeo da transmissão continue.

A natureza variável da internet se deve principalmente à atividade da rede ou à intensidade do sinal sem fio, portanto, se a taxa de dados da transmissão diminuir, os dados do buffer aumentarão na mesma medida. Se a velocidade da conexão ficar lenta a ponto de não suportar o fluxo de vídeo, o cache será preenchido com quadros de vídeo para compensar. No entanto, uma vez que o cache esteja 100% cheio, o fluxo de vídeo será comprometido, portanto, sempre que possível, você deve evitar um cache completo. Você pode executar um teste conectando um feed de vídeo e acompanhando o indicador de cache na saída de monitoramento sem ter que iniciar a transmissão. Se o cache se aproximar frequentemente de 100%, escolha uma qualidade mais baixa nas configurações de streaming ao vivo.



Medidores de Áudio

Você pode monitorar os níveis da sua fonte de áudio usando os medidores de áudio. Eles podem ser configurados para exibir os níveis de PPM ou VU nos menus de configuração do Web Presenter. Se os níveis de áudio estiverem muito altos, os medidores acenderão em vermelho, podendo significar que o áudio será distorcido ou cortado no streaming ao vivo. O ideal é tentar manter o áudio no topo da área verde e, ocasionalmente, na seção amarela.

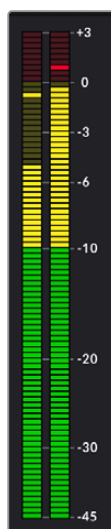

Usando o Web Presenter Setup

Quando o Blackmagic Web Presenter estiver conectado à uma rede, qualquer computador conectado à mesma rede poderá ser usado para controlar o Web Presenter remotamente. Você pode acessar os mesmos controles e configurações que estão disponíveis no painel frontal da unidade através do Blackmagic Web Presenter Setup.

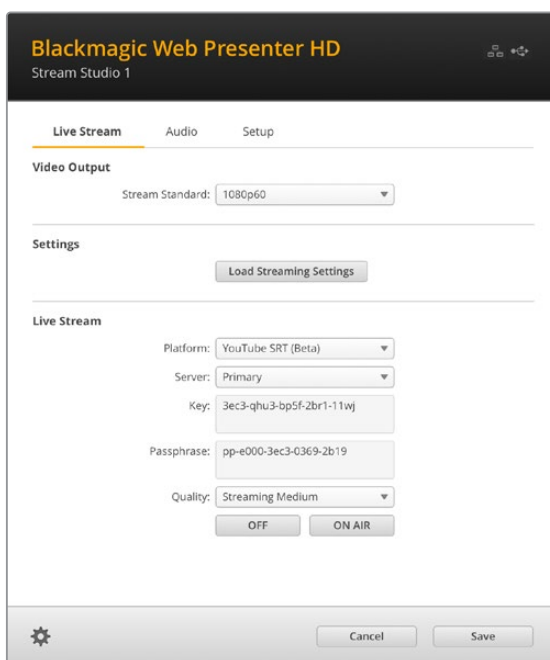
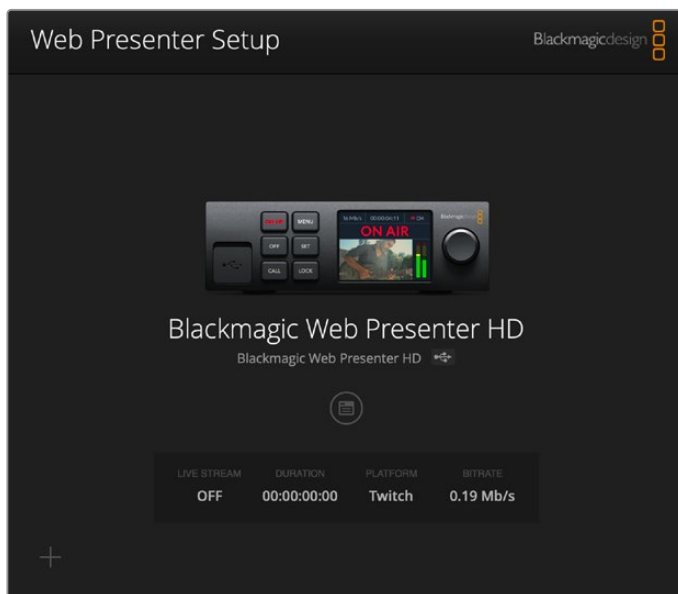

Aba Live Stream

Video Output

Stream Standard

Clique no menu “Stream Standard” para selecionar a configuração de resolução de vídeo para o seu streaming. Você pode escolher de 720p25 até 1080p60 ou 2160p60, dependendo do modelo Web Presenter que você estiver usando.

Settings

Se você tiver configurações de streaming personalizadas, por exemplo, um arquivo XML de um Blackmagic ATEM Streaming Bridge, você pode importá-las clicando no botão “Load Streaming Settings”.

Para obter mais informações sobre a criação de configurações personalizadas e conexão com ATEM Streaming Bridge, consulte a seção ‘Criando Links de Vídeo com o ATEM Streaming Bridge’.

Live Stream

Platform

Clique no menu “Plataform” e selecione a plataforma de streaming para a sua transmissão. As opções são YouTube, Facebook e Twitch. Caso tenha importado configurações personalizadas da sua transmissão, elas também aparecerão na lista “Platform”.

Para adicionar uma URL personalizada, selecione a opção de URL personalizada no menu “Platform”. No Web Presenter 4K, você pode transmitir para uma URL personalizada usando H.264 ou H.265 e no Web Presenter HD para uma URL personalizada usando H.264.

Server

Selecione o servidor mais próximo da sua localização. A lista de servidores varia de acordo com a plataforma de streaming escolhida.

Caso esteja transmitindo para o Instagram, o Microsoft Teams ou para uma URL personalizada, você poderá editar o campo da lista de servidores. Digite a URL fornecida pela sua conta na plataforma de streaming ou os detalhes da URL personalizada.

Key

Insira a chave de streaming atribuída à sua transmissão pela sua plataforma de streaming.

Passphrase

Se você estiver usando um serviço de streaming com o protocolo de transmissão SRT, digite a frase de acesso fornecida pela sua plataforma de streaming em sua conta.

Quality

Selecione a qualidade do streaming para HD ou 4K, dependendo do modelo Web Presenter que você estiver usando.

H.264	
HD	4K
HyperDeck High 45 to 70 Mb/s	HyperDeck High 95 to 220 Mb/s
HyperDeck Medium 25 to 45 Mb/s	HyperDeck Medium 66 to 150 Mb/s
HyperDeck Low 12 to 20 Mb/s	HyperDeck Low 38 to 80 Mb/s
Streaming High 6 to 9 Mb/s	Streaming High 34 to 51 Mb/s
Streaming Medium 4.5 to 7 Mb/s	Streaming Medium 23 to 35 Mb/s
Streaming Low 3 to 4.5 Mb/s	Streaming Low 13 to 20 Mb/s

H.265	
HD	4K
Streaming High 2,3 a 4,5 Mb/s	Streaming High 22,5 a 30 Mb/s
Streaming Medium 1,5 a 3 Mb/s	Streaming Medium 14 a 20 Mb/s
Streaming Low 0,8 a 2 Mb/s	Streaming Low 8 a 10 Mb/s

A taxa de dados usada pela configuração de qualidade mudará dependendo do padrão de vídeo no qual o Web Presenter estiver operando. Por exemplo, se você selecionar qualidade “Streaming High” e estiver operando em 1080p24, a taxa de dados de 6 Mb/s seria utilizada.

Como pode perceber na tabela, as taxas de dados de streaming são mais baixas em comparação com as taxas HyperDeck. Isso ocorre porque a transmissão de dados via internet normalmente utiliza uma largura de banda mais baixa do que a gravação de dados em um disco.

Você notará que cada configuração tem duas taxas de dados mencionadas. O número mais baixo é usado para as taxas de quadro mais baixas de 24p, 25p e 30p, enquanto as taxas de dados mais altas são usadas quando você estiver trabalhando com taxas de quadro mais altas de 50p e 60p. Também é importante notar que a configuração padrão para a qualidade de streaming é “Streaming High”, que oferece um streaming de altíssima qualidade.

Botões “Off” e “On Air”

Você pode iniciar ou interromper uma transmissão ao vivo usando os botões “Off” e “On Air”. O botão “On Air” acenderá em vermelho quando uma transmissão ao vivo estiver em andamento.

Remover Configurações Importadas

Para remover todas as configurações importadas do seu Web Presenter, clique no ícone de engrenagem na parte inferior esquerda da aba “Live Stream”. Para confirmar a seleção, clique em “Remove”.

Aba Audio

A aba Audio traz todas as opções para configurar a saída de monitoramento de áudio e os medidores de áudio do Web Presenter.

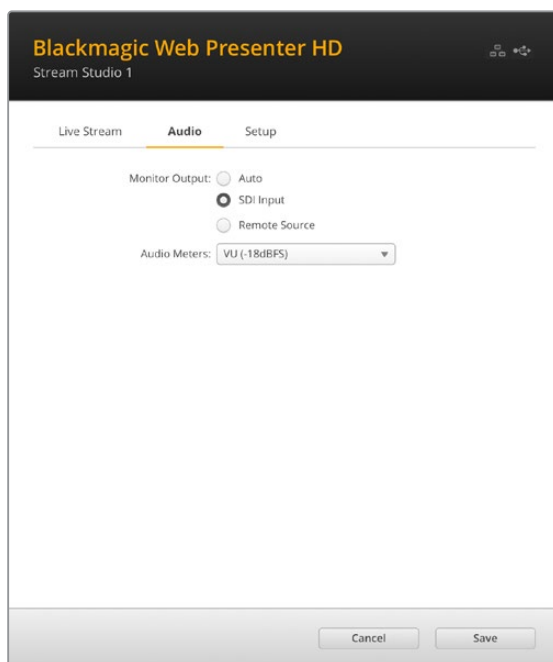

Monitor Output

Use as opções da saída de monitoramento para escolher a fonte de áudio utilizada pelas saídas de monitoramento SDI e HDMI do Web Presenter.

Auto

Quando a saída de monitoramento estiver definida como "Auto", o Web Presenter detectará automaticamente e monitorará o áudio da intercomunicação enviado de um switcher ATEM através de um ATEM Streaming Bridge. Se nenhuma intercomunicação for detectada, o áudio da entrada SDI será usado.

SDI Input

Selecione "SDI Input" para monitorar o áudio da fonte de entrada SDI do Web Presenter, por exemplo, uma Blackmagic Studio Camera conectada.

Remote Source

Use esta opção para monitorar o áudio da intercomunicação enviado de um switcher ATEM remoto ou de um ATEM Streaming Bridge.

Audio Meters

Use este menu para selecionar qual tipo de medidor de áudio exibir. As opções disponíveis são níveis de referência VU -18dBFS, VU -20dBFS, PPM -18dBFS ou PPM -20dBFS.

Aba Setup

Blackmagic Web Presenter HD
Stream Studio 1

Live Stream Audio **Setup**

Name: Stream Studio 1
Language: English
Software: Version 3.3

Network

Protocol: DCHP Static IP

IP Address: 192.168.24.100
Subnet Mask: 255.255.255.0
Gateway: 192.168.24.1
Primary DNS: 8.8.8.8
Secondary DNS: 8.8.4.4

Connection Priority: Ethernet Mobile

Reset

Factory Reset

Cancel Save

Name

Caso queira renomear seu Web Presenter, digite um novo nome na caixa e clique em “Save”.

Language

Permite alterar a configuração de idioma da unidade.

Software

Exibe a versão atual do software Web Presenter.

Network

Essas configurações permitem definir opções, como conectar-se a uma rede por DHCP ou usar um endereço IP estático. Para obter mais informações sobre como conectar seu Web Presenter a uma rede, consulte a seção ‘Configurações de Rede’.

Prioridade de Conexão - Quando Ethernet e um telefone celular estão conectados ao Web Presenter, esta configuração permite que você escolha qual conexão será usada para streaming. Para mais informações sobre tethering de smartphones, consulte a seção ‘Streaming via Smartphone’.

Reset

Restaure o seu Web Presenter clicando no botão “Factory Reset”.

Configurações de Rede

O Web Presenter pode se conectar à rede usando um endereço IP estático ou DHCP.

DHCP - Definirá automaticamente um endereço IP para sua unidade e conectará à rede sem nenhuma alteração nas configurações.

O protocolo dinâmico de configuração do host, ou DHCP, é um serviço em servidores de rede que encontra automaticamente o seu Web Presenter e atribui um endereço IP. O DHCP facilita a conexão de equipamentos via Ethernet e garante que seus endereços IP não entrem em conflito entre si. A maioria dos computadores e switchers de rede suportam DHCP.

IP Estático - Para definir o endereço IP, basta definir a configuração do protocolo para "IP Estático" e alterar as configurações de IP manualmente.

Um endereço IP estático não muda mesmo se o seu Web Presenter for ligado e desligado novamente.

O uso de um endereço IP estático pode ser necessário se o seu Web Presenter estiver conectado a uma rede corporativa. Se você tiver um administrador de rede, é possível que sua rede tenha endereços IP personalizados para todos os equipamentos conectados a ela. É aconselhável verificar com os administradores de rede se eles estão gerenciando os computadores e rede de sua empresa.

Configurando Compartilhamento de Internet para Streaming Direto

Se não for possível conectar o Web Presenter diretamente a uma rede ou roteador de internet, você pode compartilhar a conexão de internet do seu computador com o Web Presenter através da porta Ethernet.

Como configurar o Blackmagic Web Presenter para streaming direto:

- 1 Configure o seu Web Presenter para usar DHCP.
- 2 Configure seu computador para compartilhar a conexão de internet via porta Ethernet.

Mac: Nas Preferências do Sistema, clique em "Compartilhamento" e selecione "Compartilhar Internet" na lista de serviços. No menu local "Compartilhar sua conexão de", escolha "Wi-Fi" caso o seu Mac esteja conectado à internet via Wi-Fi. Na lista "Para computadores usando", selecione "Ethernet". Na lista de serviços, selecione "Compartilhamento de Internet". Se tiver certeza de que deseja ativar o compartilhamento de internet, clique em "Iniciar".

Windows: Clique com o botão direito do mouse no ícone "Iniciar" e selecione "Conexões de Rede". A tela "Status" será exibida. Clique em "Alterar opções de adaptador". Será exibida uma lista das conexões de rede do seu computador. Clique com o botão direito do mouse na conexão de internet e selecione "Propriedades". Na aba "Compartilhamento", marque a caixa "Permitir que outros usuários da rede se conectem pela conexão deste computador à Internet". Selecione uma conexão de rede no menu e clique em "OK".

- 3 Conecte o Web Presenter à porta Ethernet do seu computador. Após alguns segundos, o DHCP atribuirá um endereço IP ao Web Presenter.
- 4 Confirme se o seu Web Presenter está conectado à internet via Ethernet observando o ícone Ethernet no canto superior direito da tela LCD da unidade.

Streaming via Smartphone

O Blackmagic Web Presenter é capaz de realizar o streaming por tethering com o seu smartphone. Isso significa que você pode transmitir para o mundo inteiro em qualquer local onde o seu smartphone estiver conectado à rede celular.

Como configurar tethering móvel:

- 1 Conecte um cabo entre o seu smartphone e a porta USB-C do seu Web Presenter. Você pode usar o conector USB-C do painel frontal ou traseiro.
- 2 Habilite o compartilhamento de internet (hotspot) do seu smartphone.

No seu dispositivo iOS, clique em Ajustes > Acesso Pessoal e certifique-se de que a opção “Permitir Acesso a Outros” esteja habilitada. Para dispositivos Android, deslize a tela para exibir o menu rápido. Pressione e segure o ícone de hotspot e, em seguida, ative o “Vínculo por USB (tethering)”.

Agora você pode pressionar o botão “On Air” no seu Blackmagic Web Presenter para entrar no ar.

DICA Após o término da transmissão, é recomendável desativar as conexões compartilhadas para economizar bateria.

Se o seu Web Presenter tiver um cabo Ethernet conectado, é recomendável confirmar se ele está configurado para usar tethering de internet móvel. Abra o utilitário Web Presenter Setup e vá até aba “Setup”. Na aba “Network”, defina a prioridade de conexão para “Mobile”.

Usando Blackmagic Web Presenter como uma Webcam

Programas como Skype ou Zoom devem definir o Web Presenter como webcam automaticamente, de modo que, ao iniciar o aplicativo, você verá o vídeo do Web Presenter imediatamente. Se o seu aplicativo não selecionar o Web Presenter, basta configurar o aplicativo para usar o Web Presenter como webcam e microfone.

Abaixo está um exemplo de como definir as configurações da webcam no Skype.

- 1 Na barra de menu do Skype, abra as “Configurações de Vídeo e Áudio”.
- 2 Clique no menu “Câmera” e selecione seu Web Presenter na lista. Você verá o vídeo do Web Presenter aparecer na janela de visualização.
- 3 Vá até o menu “Microfone” e selecione seu Web Presenter como sua fonte de áudio.

Configurar Open Broadcaster

O Open Broadcaster é um aplicativo de código aberto que funciona como uma plataforma de streaming entre o seu Web Presenter e a sua plataforma de streaming favorita, como YouTube, Twitch, Facebook Live, entre outras. O Open Broadcaster comprime o seu vídeo para uma taxa de bits que a plataforma de streaming possa controlar.

Abaixo está uma demonstração de como configurar o Open Broadcaster para transmitir a saída da webcam do seu Web Presenter usando o YouTube como aplicativo de streaming.

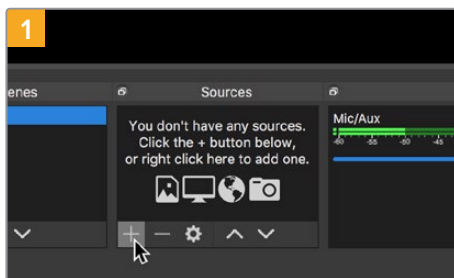

Execute o Open Broadcaster e clique no ícone + na caixa “Fontes”.

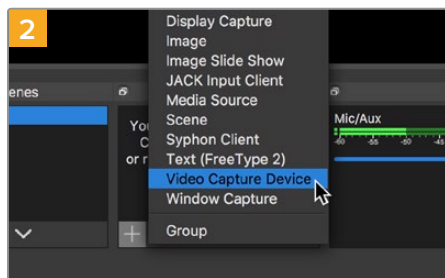

Selecione “Dispositivo de Captura de Vídeo”.

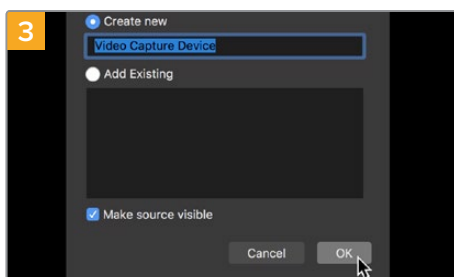

Nomeie a nova fonte e clique em “OK”.

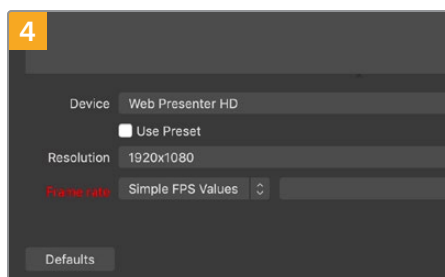

No menu “Dispositivo”, selecione o seu modelo Web Presenter e clique em “OK”.

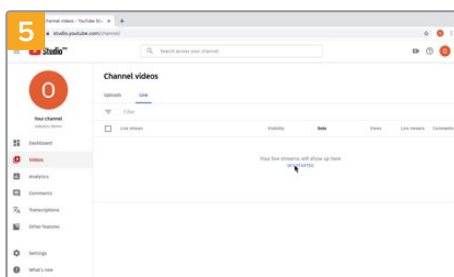

Agora vá até a sua conta no YouTube. Navegue até a opção “Vídeo/Ao Vivo” e clique em “Transmissão ao vivo”.

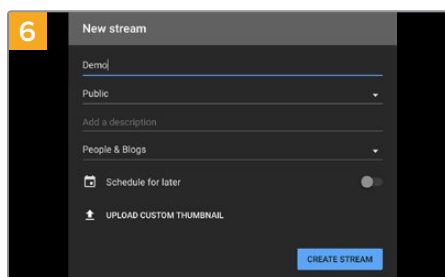

Nas opções de “Transmissão” do YouTube, insira os detalhes da sua transmissão e clique em “Criar”.

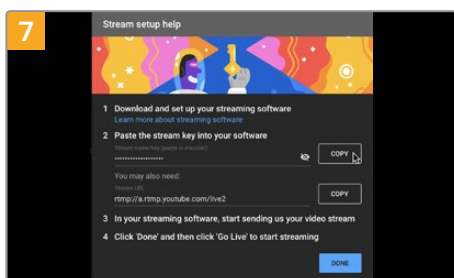

O YouTube gerará um “Nome/chave do stream” que irá direcionar o Open Broadcaster à sua conta no YouTube. Clique no botão “Copiar” ao lado da chave do stream. Copie a chave de streaming que você deseja colar no Open Broadcaster.

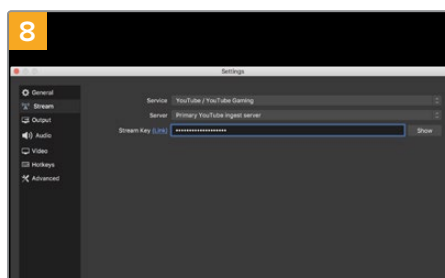

Retorne ao Open Broadcaster e abra as preferências clicando em “OBS/Preferências” na barra de menu. Selecione “Stream”. Agora cole a chave do stream que você copiou do YouTube e clique em “OK”.

Agora você verá o vídeo do seu Web Presenter na janela de pré-visualização de streaming do Open Broadcaster.

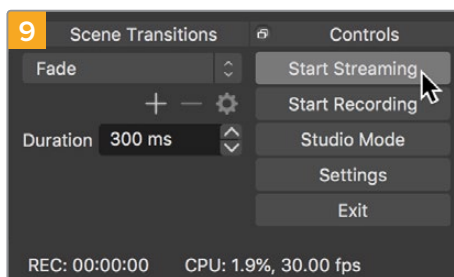

Para conectar o link de transmissão do Open Broadcaster ao YouTube, clique em “Iniciar Transmissão”, no canto inferior direito da tela. Isso estabelece o link com o YouTube a partir do Open Broadcaster. A partir deste ponto, tudo será definido usando o YouTube Live.

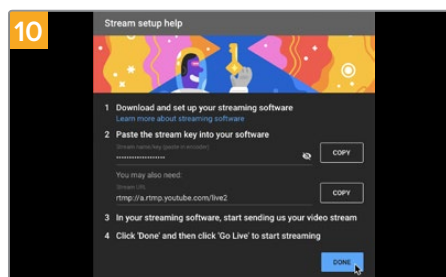

Retorne ao YouTube Live e você verá a saída de programa webcam do Web Presenter em segundo plano. Clique para concluir.

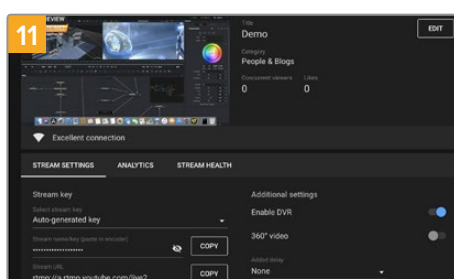

Com o Open Broadcaster se comunicando com o YouTube Live, você está pronto para começar sua transmissão. Agora é hora de verificar os últimos detalhes e assegurar que tudo está funcionando corretamente.

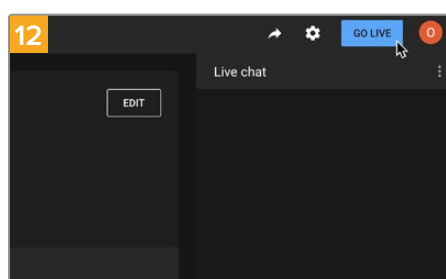

Se estiver tudo pronto, agora você pode começar sua transmissão clicando em “Transmitir Ao Vivo”.

Agora você está transmitindo ao vivo no YouTube com o Open Broadcaster.

OBSERVAÇÃO Devido à natureza do streaming na internet, muitas vezes pode haver um atraso, por isso é importante assistir à transmissão no YouTube e confirmar se o seu programa terminou antes de clicar para encerrar a transmissão. Dessa forma, você evita cortar o final da sua transmissão acidentalmente.

Criando Links de Vídeo com o ATEM Streaming Bridge

O ATEM Streaming Bridge permite decodificar um streaming de vídeo de qualquer Web Presenter e reconverter para vídeos SDI e HDMI. Você pode enviar vídeos através da sua rede local ou para qualquer lugar do mundo via internet.

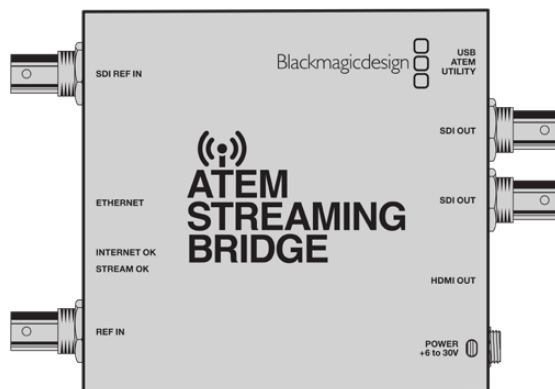

Se o seu ATEM Streaming Bridge estiver conectado à mesma rede local que o Web Presenter, ele será listado no menu “Platform” na aba “Live Stream” do Web Presenter Setup.

Caso contrário, você pode carregar um arquivo XML de configuração de streaming em uma unidade USB conectada ao Web Presenter ou através de um computador acessando o Web Presenter Setup.

Um bom exemplo de como o Blackmagic Web Presenter pode trabalhar com o ATEM Streaming Bridge é a transmissão de um boletim meteorológico de uma locação remota para um estúdio. Tudo o que você precisa para transmitir direto da locação é um Web Presenter e uma conexão com a internet, que pode ser o seu smartphone ou uma conexão à rede.

No estúdio, o ATEM Streaming Bridge pega o feed da internet e o converte em SDI para que ele possa ser conectado ao switcher principal do estúdio.

A configuração do fluxo de trabalho para este exemplo seria:

- 1 Na locação, o Blackmagic Web Presenter é conectado à saída SDI de programa no switcher. Por exemplo, um ATEM Constellation 8K.
- 2 Em seguida, o Blackmagic Web Presenter é conectado a um smartphone.
- 3 No estúdio, o ATEM Streaming Bridge também está conectado à internet via Ethernet.
- 4 O ATEM Streaming Bridge envia o feed de vídeo SDI convertido da internet para a entrada SDI do switcher do estúdio para a transmissão no noticiário.

Para que o seu estúdio conecte o ATEM Streaming Bridge ao feed de internet do Web Presenter, você precisará iniciar o utilitário ATEM Setup e definir as configurações de internet. Isso inclui a geração de um arquivo XML contendo todas as configurações de streaming que serão carregadas no Web Presenter em locação.

Criando o Arquivo XML

Para criar um arquivo de configurações XML, conecte o ATEM Streaming Bridge à internet plugando um cabo de rede entre a porta “Ethernet” e um roteador de internet ou switch de rede.

Conecte o ATEM Streaming Bridge ao seu computador usando um cabo USB-C e inicie o ATEM Setup.

Na aba “Setup”, verifique se as configurações de rede estão corretas e selecione “Internet” nas opções “Stream Service”. Na janela de status da internet, será exibida a mensagem “Visible Worldwide”. Isso significa que tudo está funcionando corretamente.

Observação sobre Encaminhamento de Porta

Caso você observe um erro relacionado a encaminhamento de porta ou UPnP na janela de status “Internet Status”, solicite ao seu provedor de internet ou administrador de rede que configure o encaminhamento de porta na sua conexão de internet como “TCP port 1935”.

Exportando o Arquivo XML

Depois de confirmar suas configurações na aba ATEM Setup e conectar o ATEM Streaming Bridge à rede ou internet com sucesso, você pode exportar o arquivo de configurações XML.

- 1 Clique na aba “External ATEM Mini Pro” no canto superior direito da janela.

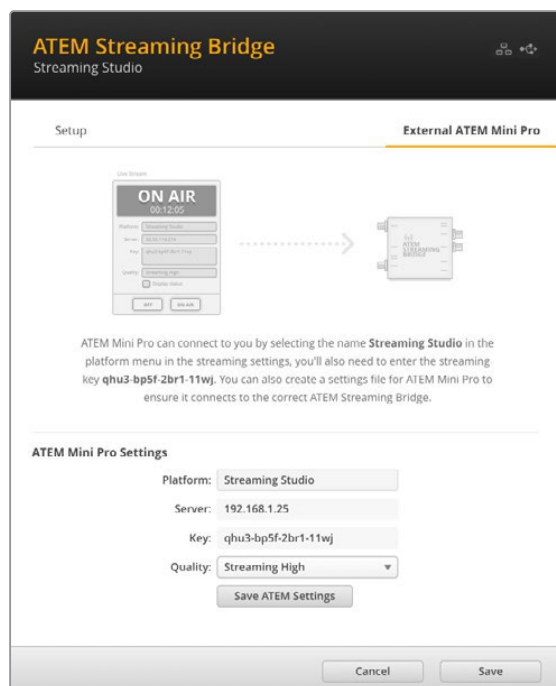

- 2 Para dar um nome personalizado à plataforma, clique na janela “Platform” e digite um novo nome. Esse nome será o nome listado no menu “Platform” da unidade Blackmagic remota.
- 3 Selecione a qualidade do seu streaming. Isso determinará a configuração de qualidade no Web Presenter remoto.
- 4 Clique no botão “Save ATEM Settings”, escolha um local no seu computador para salvar o arquivo XML e clique em “Save”.
- 5 Agora, você pode enviar o arquivo XML salvo para o operador remoto via email.

DICA Você pode usar as configurações de intercomunicação no ATEM Setup para selecionar os canais de áudio que deseja reenviar ao Web Presenter remoto.

Carregando o arquivo XML

Com o arquivo de configurações enviado à locação por email, a equipe da locação simplesmente carrega o XML no Web Presenter usando o Blackmagic Web Presenter Setup e pressiona “No Ar” para iniciar o streaming do boletim metereológico para o estúdio.

É importante observar que, uma vez que você carregou o arquivo XML de streaming, você pode iniciar e interromper streamings sem nunca ter que carregá-lo novamente. Isso facilita a configuração de um link de vídeo constante entre o Web Presenter e o ATEM Streaming Bridge.

Contanto que o ATEM Streaming Bridge no estúdio não tenha alterado as configurações de streaming e rede e continue procurando por esse Web Presenter, o ATEM sempre o encontrará, não importa onde ele esteja na internet. Em qualquer local, você pode simplesmente conectar seu Web Presenter à internet, pressionar “On Air” e ele realizará o streaming para o ATEM Streaming Bridge no estúdio.

Para mais detalhes sobre como usar o ATEM Streaming Bridge, consulte o manual do ATEM Mini, disponível para download em www.blackmagicdesign.com/br/support

Sinalização, Intercomunicação e Controle de Câmera

O ATEM Streaming Bridge e o Blackmagic Web Presenter também permitem que os switchers ATEM enviem informações de sinalização, intercomunicação e controle de câmera. Isso significa que qualquer câmera Blackmagic Design baseada em SDI pode ser posicionada em qualquer locação dentro sua rede local, ou em qualquer lugar do mundo através da internet, e ainda assim contar com funções de sinalização, intercomunicação e controle de câmera.

A configuração é muito simples. A ilustração abaixo mostra como conectar uma URSA Mini Pro 4.6K a um ATEM Constellation 8K, através de uma rede local, com sinalização, intercomunicação e controle de câmera.

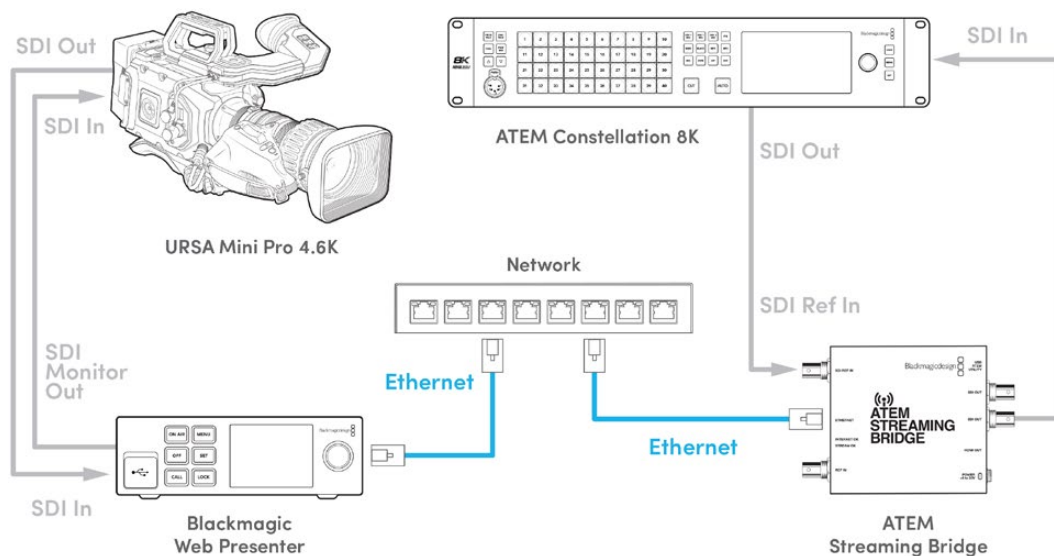

Quando tudo estiver conectado:

- 1 Pressione o botão “Menu” no Blackmagic Web Presenter para abrir o menu LCD e navegar até o menu “Stream Ao Vivo”.
- 2 Selecione o ATEM Streaming Bridge no menu “Plataforma”.
- 3 Pressione “Set” para confirmar.

Para que a sinalização funcione, é preciso garantir que o ID de câmera ATEM na câmera esteja configurado para corresponder à entrada no switcher. Para mais informações sobre como configurar o ID de Câmera ATEM, consulte o manual da URSA Mini.

Você pode testar o funcionamento da sinalização alternando a câmera para a saída de programa no switcher ATEM. Se o ID de câmera ATEM estiver configurado corretamente na sua câmera, a luz de sinalização acenderá e uma borda vermelha será exibida em torno do LCD da câmera. Agora, alterne a câmera para a saída de pré-visualização e a sinalização acenderá em verde.

Experimente ajustar a íris e o pedestal na página de câmera do ATEM Software Control para testar o controle de câmera.

Os canais de áudio SDI embutido 15 e 16 estão configurados como os canais-padrão para intercomunicação, mas você pode alterar para os canais técnicos 13 e 14 ou a saída de programa com o utilitário ATEM Setup.

Ao transmitir via internet, o arquivo de configurações XML é criado por meio do utilitário ATEM Setup. Em seguida, o arquivo XML é carregado no Blackmagic Web Presenter para que ele possa encontrar o ATEM Streaming Bridge na internet. Para mais informações sobre como criar e carregar o arquivo de configurações XML, consulte a seção anterior deste manual.

Conectando a URSA Broadcast G2

A URSA Broadcast G2 possui um mecanismo de streaming. Portanto, não é necessário utilizar um Blackmagic Web Presenter, pois a câmera é capaz de fazer o streaming diretamente através de sua porta de expansão USB-C.

Consulte o manual da URSA Broadcast G2 para mais informações, incluindo como configurar o ID de câmera ATEM de modo que a sinalização funcione corretamente.

Blackmagic Universal Rack Shelf

A Blackmagic Universal Rack Shelf é uma prateleira de 1U que permite instalar uma ampla gama de equipamentos Blackmagic Design em um rack profissional ou em um case técnico. Graças ao design modular, é possível montar configurações de equipamentos portáteis e práticos usando produtos que compartilham um fator de forma de uma unidade de rack.

A ilustração abaixo mostra três Universal Rack Shelves instaladas em um pequeno rack, com uma combinação de unidades compatíveis encaixadas. A prateleira inferior inclui uma frente falsa com 1/3 de unidade de rack de largura para preencher o espaço não utilizado entre as unidades.

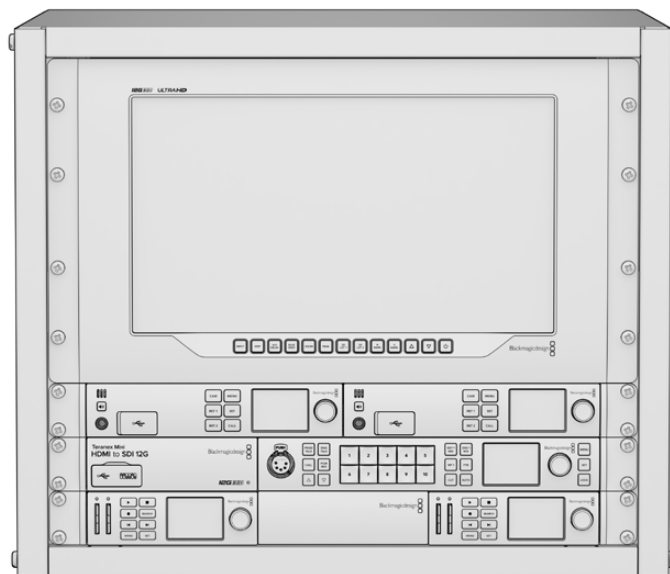

Conteúdo

O kit Universal Rack Shelf contém os seguintes itens:

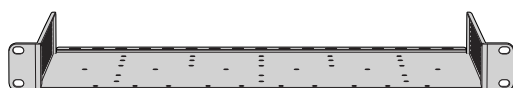

1 x Blackmagic Universal Rack Shelf

Uma prateleira de largura completa com uma unidade de rack para instalar equipamentos Blackmagic Design.

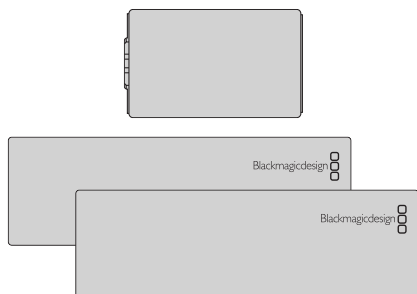

Frentes falsas

1 x frente falsa com 1/6 de unidade de rack de largura e 2 x frentes falsas com 1/3 de unidade de rack de largura para cobrir lacunas na prateleira.

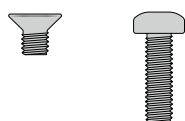

Parafusos

12 x parafusos M3 escareados de 5 mm.

2 x parafusos M3 lisos de 9 mm para as frentes falsas de 1/6 U.

Montar a Unidade no Rack

- 1 Se os pés emborrachados estiverem instalados, remova-os da base da unidade utilizando uma ferramenta de extração plástica.
- 2 Com a prateleira e a unidade de cabeça para baixo, alinhe os orifícios pré-perfurados da prateleira com os orifícios de montagem rosqueados na base da unidade Blackmagic Design. Você encontrará dois pontos de montagem centrais em produtos com 1/3 de unidade de rack de largura ou até três pontos de montagem em produtos maiores com 1/2 de unidade de rack de largura.

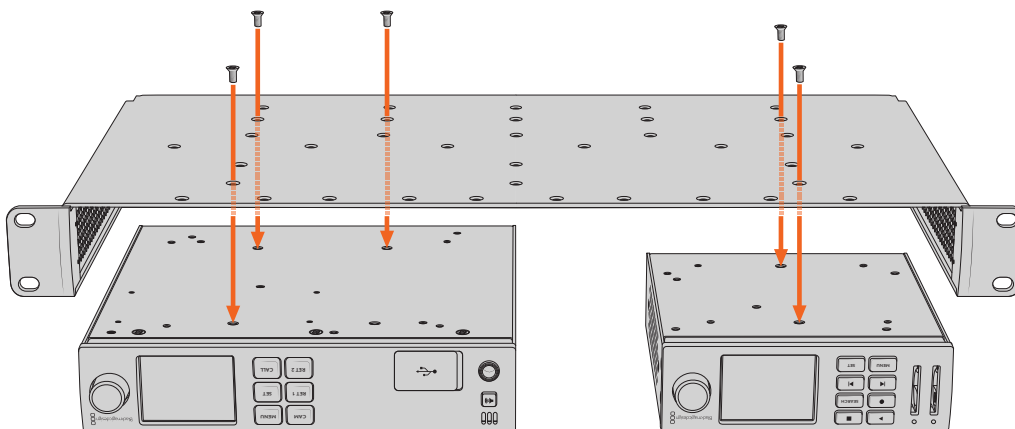

- 3 Utilizando os parafusos M3 escareados de 5 mm fornecidos, fixe a unidade à prateleira.
- 4 Após fixar, vire a prateleira de volta à posição normal e instale-a no rack utilizando as orelhas de rack integradas.

As frentes falsas fornecidas podem ser utilizadas para cobrir lacunas na prateleira.

Encaixar a Frente Falsa de 1/6

A frente falsa de 1/6 pode ser utilizada para preencher o espaço não utilizado na prateleira ao montar unidades com 1/2 e 1/3 de unidade de rack de largura. O painel pode ser fixado nas laterais de qualquer uma das unidades. Para melhorar o fluxo de ar, é recomendável montar o painel entre as unidades.

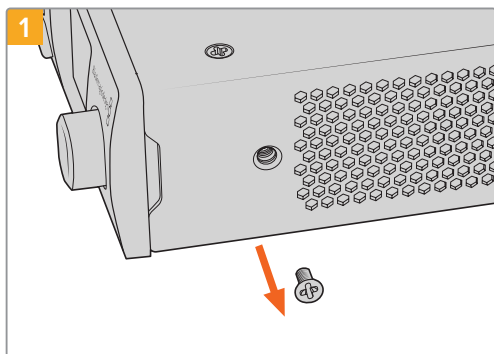

Remova o parafuso M3 de 5 mm próximo ao painel frontal da unidade.

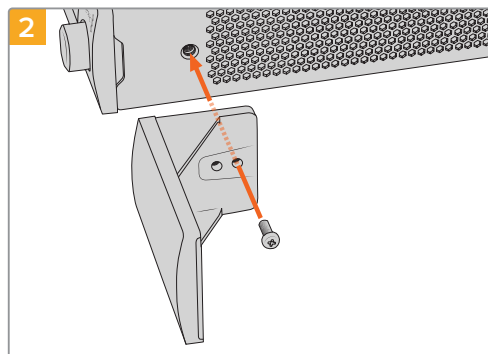

Alinhe a frente falsa e encaixe-a utilizando o parafuso de nylon M3 de 9 mm fornecido.

Encaixar a Frente Falsa de 1/3

As frentes falsas de 1/3 de largura podem ser fixadas diretamente em ambos os lados da prateleira ao montar unidades individuais. Para instalar uma frente falsa, alinhe os orifícios dos parafusos e o ponto de ancoragem na base do painel com a prateleira e aparafuse utilizando dois dos parafusos M3 de 5 mm escareados fornecidos.

Atualizando o Software Interno

O utilitário de configuração permite atualizar o software interno do seu Web Presenter, além de definir as configurações de streaming, configurações de rede e qualidade de streaming.

Como atualizar o software interno:

- 1 Baixe o instalador do Blackmagic Web Presenter mais recente em www.blackmagicdesign.com/br/support.
- 2 Execute o instalador do Blackmagic Web Presenter e siga as instruções na tela.
- 3 Após a instalação, conecte o seu Web Presenter ao computador via o conector USB no painel frontal ou traseiro embaixo da proteção emborrachada antipoeira.
- 4 Inicie o Blackmagic Web Presenter Setup e siga as orientações na tela para atualizar o programa interno. Caso nenhuma instrução apareça, o software interno está atualizado e não há nada mais que você precise fazer.

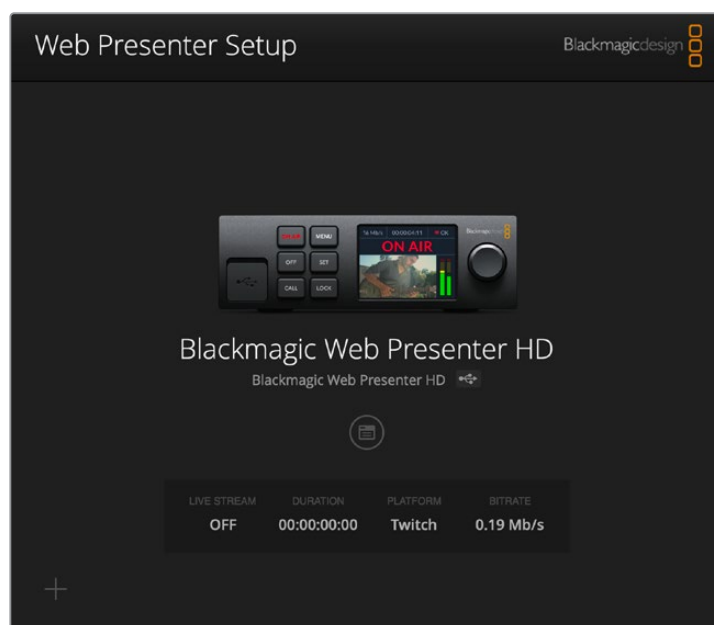

Baixe o utilitário de instalação mais recente para o seu Blackmagic Web Presenter na central de suporte técnico da Blackmagic Design em www.blackmagicdesign.com/br/support

Developer Information

Blackmagic Web Presenter Ethernet Protocol

v1.2

Protocol Details

Overview

The Blackmagic Web Presenter Ethernet Protocol is a line-oriented, text-based protocol to control a Web Presenter.

Lines from the Web Presenter server will be separated by an ASCII LF sequence.

Messages from the user may be separated by LF or CR LF.

Connection

The Web Presenter server is accessed by connecting to TCP port 9977 on a Web Presenter.

Connection Response

Upon connection, the Web Presenter server sends a dump of the device's state.

The Web Presenter server sends information in blocks, with each having an identifying header followed by a colon. A block spans multiple lines and is terminated by a blank line. Each line in the protocol is terminated by a newline character.

Following the header, a block contains either a single multi-line string or a sequence of key/value pairs arranged one per line. The first full-colon on a line is used to delimit the key and the value. A value may be a comma separated list. In this case, values in the list must have the “,” and “\” characters escaped with a “\” character.

To be resilient to future protocol changes, clients should ignore blocks they do not recognize, up to the trailing blank line. Within recognized blocks, clients should ignore keys they do not recognize.

Legend	
↵	End of line
...	and so on
Orange Text	Client Generated
Grey Text	Server Generated

The protocol preamble block is always the first block sent by the Web Presenter server:

```
PROTOCOL PREAMBLE:↵
Version: 1.2↵
↵
```

The version field indicates the protocol version. When the protocol is changed in a compatible way, the minor version number will be updated. If incompatible changes are made, the major version number will be updated.

The initial status dump is concluded by the end prelude block:

```
END PRELUDE:↵
↵
```

Status Updates

When any device parameter is changed on the Web Presenter server by any client, such as the Blackmagic Web Presenter Setup utility, the Web Presenter server resends the applicable status block, containing only the items that have changed. Status updates can also occur due to external changes such as tethering to a smartphone or when a streaming service is disconnected.

For example, if the input video mode is set to Auto, the following block will be sent:

```
STREAM SETTINGS:↵  
Video Mode: Auto↵  
↵
```

Requesting Changes

To change one or more parameters in a block, the client should send the appropriate block header in the same form the Web Presenter server sends, followed by the key/value pairs to be changed. For example, to change the input video format to 1080p59.94, the user should send the following block:

```
STREAM SETTINGS:↵  
Video Mode: 1080p59.94↵  
↵
```

The block must be terminated by a blank line. On receipt of a blank line, the Web Presenter server will either acknowledge the request by responding:

```
ACK↵  
↵
```

or if unable to parse the block responding with:

```
NACK↵  
↵
```

After a positive response, the client should expect to see a status update from the Web Presenter server showing the status change. This is likely to be the same as the command that was sent, sometimes followed by other blocks providing data specific to the change.

```
STREAM SETTINGS:↵  
Video Mode: 1080p59.94↵  
↵
```

If the Web Presenter server does not understand a key in the requested block, the key will be ignored. If an invalid value is provided for a known key, then the request is ignored and the Web Presenter will respond with the existing value for the key. In both cases the Web Presenter server will still respond with an ACK.

```
STREAM SETTINGS:↵  
Video Mode: UnsupportedMode↵  
↵  
ACK↵  
↵  
STREAM SETTINGS:↵  
Video Mode: 1080p59.94↵  
↵
```

Requesting a Status Dump

The user may request that the Web Presenter server resend the complete state of any status block by sending the block header, followed by a blank line. In the following example, the user requests the Web Presenter server resend the stream settings:

```
STREAM SETTINGS:↵
↵
ACK↵
↵
STREAM SETTINGS:↵
Video Mode: 1080p59.94↵
...
↵
```

Protocol Blocks

Identity Block

The identity block contains information to identify the connected Web Presenter.

Block Syntax

The following example shows the Identity Block for a Blackmagic Web Presenter HD.

```
IDENTITY:↵
Model: Blackmagic Web Presenter HD↵
Label: Blackmagic Web Presenter HD↵
Unique ID: 00112233445566778899AABBCCDDEEFF↵
↵
```

Parameters

Key	Read/Write	Description	Valid Values
Model	Read only	The Web Presenter model name	String
Label	Read/Write	A display name for the Web Presenter	String
Unique ID	Read only	A device specific unique identifier	Hexadecimal ID

Changing Device Label

A device label to identify the Web Presenter can be changed by sending an identity block with label key.

```
IDENTITY:↵
Label: My Web Presenter↵
↵
ACK↵
↵
IDENTITY:↵
Label: My Web Presenter↵
↵
```

Version Block

The version block contains hardware and software version information for the connected Web Presenter.

Block Syntax

```
VERSION:↵  
Product ID: BE73↵  
Hardware Version: 0100↵  
Software Version: 0123ABCD↵  
Software Release: 3.3↵  
↵
```

Parameters

Key	Read/Write	Description	Valid Values
Product ID	Read only	The Web Presenter product ID	Hexadecimal ID
Hardware Version	Read only	The Web Presenter hardware version	Hexadecimal version
Software Version	Read only	The Web Presenter software version	Hexadecimal version
Software Release	Read only	The Web Presenter software release version	Version Number

Network Blocks

The network block contains the TCP/IP networking configuration for the connected Web Presenter.

Block Syntax

This example shows the output for a connected Web Presenter. It displays 2 networking interfaces - the Gigabit Ethernet interface and option for a tethered smartphone.

The network settings prefixed with Current show the active TCP/IP settings, and are read-only. The Current settings reflect either the DHCP or Static configuration, depending on the Dynamic IP flag.

```
NETWORK:↵  
Interface Count: 2↵  
Default Interface: 0↵  
↵  
NETWORK INTERFACE 0:↵  
Name: Ethernet↵  
Priority: 1↵  
MAC Address: 00:11:22:33:44:55↵  
Dynamic IP: true↵  
Current Addresses: 192.168.1.10/255.255.255.0↵  
Current Gateway: 192.168.1.1↵  
Current DNS Servers: 192.168.1.1, 8.8.8.8, 8.8.4.4↵  
Static Addresses: 10.0.0.2/255.255.255.0↵  
Static Gateway: 10.0.0.1↵  
Static DNS Servers: 8.8.8.8, 8.8.4.4↵  
↵
```

```

NETWORK INTERFACE 1:↵
Name: USBEthernet↵
Priority: 0↵
MAC Address: 00:00:00:00:00:00↵
Dynamic IP: true↵
Current Addresses: 0.0.0.0/255.255.0.0↵
Current Gateway: 0.0.0.0↵
Current DNS Servers: ↵
Static Addresses: 10.0.0.2/255.255.255.0↵
Static Gateway: 10.0.0.1↵
Static DNS Servers: 8.8.8.8, 8.8.4.4↵
↵

```

Parameters

Network Block

Key	Read/Write	Description	Valid Values
Interface Count	Read only	The number of networking interfaces supported by the Web Presenter	Integer
Default Interface	Read only	The default networking interface	Integer

Network Interface Block

Key	Read/Write	Description	Valid Values
Name	Read only	The name of the networking interface	String
Priority	Read/Write	The priority of the network interface. When multiple network interfaces are available, the high priority interface will become the default	Unsigned integer. The higher number is the higher priority
MAC Address	Read Only	MAC address of the networking interface	IEEE 802 MAC address
Dynamic IP	Read/Write	Selects DHCP or Static IP configuration	true - DHCP enabled false - Static IP
Current Addresses	Read Only	The current IP address and Subnet mask	{IPv4 address}/{Subnet Mask}
Current Gateway	Read Only	The current IP gateway address	IPv4 address
Current DNS Servers	Read only	The IP addresses of the current DNS servers	Comma separated list of IPv4 addresses
Static Addresses	Read/Write	Status IP address and subnet mask when DHCP disabled	{IPv4 address}/{Subnet Mask}
Static Gateway	Read/Write	Static gateway address when DHCP disabled	IPv4 address
Static DNS Servers	Read/Write	The IP addresses of the static DNS servers	Comma separated list of IPv4 addresses

Changing Networking Settings

The network can be configured to use either DHCP or a static configuration. To enable DHCP on Network Interface 0:

```
NETWORK INTERFACE 0:↵  
Dynamic IP: true↵  
↵  
ACK↵  
↵  
NETWORK INTERFACE 0:↵  
Dynamic IP: true↵  
↵
```

To set a fixed IP address, supply all static parameters:

```
NETWORK INTERFACE 0:↵  
Dynamic IP: false↵  
Static Addresses: 192.168.1.2/255.255.255.0↵  
Static Gateway: 192.168.1.1↵  
Static DNS Servers: 8.8.8.8, 8.8.4.4↵  
↵  
ACK↵  
↵  
NETWORK INTERFACE 0:↵  
Dynamic IP: false↵  
Static Addresses: 192.168.1.2/255.255.255.0↵  
Static Gateway: 192.168.1.1↵  
Static DNS Servers: 8.8.8.8, 8.8.4.4↵  
↵
```

Changing network settings may cause the IP connection to be dropped.

UI Settings Block

The UI settings block contains the front panel LCD and monitor output settings for the connected Web Presenter.

Block Syntax

```
UI SETTINGS:↵  
Available Locales: en_US.UTF-8, zh_CN.UTF-8, ja_JP.UTF-8, ko_KR.UTF-8, es_↵  
ES.UTF-8, de_DE.UTF-8, fr_FR.UTF-8, ru_RU.UTF-8, it_IT.UTF-8, pt_BR.UTF-8,↵  
tr_TR.UTF-8, pl_PL.UTF-8, uk_UA.UTF-8↵  
Current Locale: en_US.UTF-8↵  
Available Audio Meters: PPM -18dB, PPM -20dB, VU -18dB, VU -20dB↵  
Current Audio Meter: PPM -20dB↵  
↵
```

Parameters

Key	Read/Write	Description	Valid Values
Available Locales	Read only	The locales available in the Web Presenter	Comma separated list of locales
Current Locale	Read/Write	The current locale for Web Presenter	Refer to the locales from the Available Locales field
Available Audio Meters	Read only	The available audio meters supported by the Web Presenter	Comma separated list of audio meter types
Current Audio Meter	Read/Write	The current audio meter	Refer to the audio meters from the Available Audio Meters field

Stream Settings Block

The stream settings block contains the stream configuration for the connected Web Presenter.

Block syntax

This example shows the output for a connected Web Presenter. The stream settings prefixed with Current show the active stream settings and are writable. The stream settings prefixed by Available show the available stream settings for the device or platform and are read-only. To view the available servers or quality levels for a stream service, the Current Platform stream setting should be set first.

```
STREAM SETTINGS:↵
Available Video Modes: Auto, 1080p23.98, 1080p24, 1080p25, 1080p29.97,
1080p30, 1080p50, 1080p59.94, 1080p60, 720p25, 720p30, 720p50, 720p60↵
Video Mode: 1080p59.94↵
Current Platform: YouTube↵
Current Server: Primary↵
Current Quality Level: Streaming Medium↵
Stream Key: abc1-def2-ghi3-jkl4-mno5↵
Password: ↵
Current URL: srt://192.168.8.51
Customizable URL: true
Available Default Platforms: YouTube RTMP, YouTube SRT (Beta), Facebook,
Twitch, Twitter, Restream.IO, Vimeo, BoxCast, CastR, AfreecaTV, Bilibili,
DouYu, Weibo↵
Available Custom Platforms: My Platform↵
Available Servers: Primary, Secondary↵
Available Quality Levels: HyperDeck High, HyperDeck Medium, HyperDeck Low,
Streaming High, Streaming Medium, Streaming Low↵
↵
```

Parameters

Key	Read/Write	Description	Valid Values
Available Video Modes	Read only	The video modes available in the Web Presenter	Comma separated list of video modes
Video Mode	Read/Write	The current video mode	Refer to the video modes from the <i>Available Video Modes</i> field
Current Platform	Read/Write	The selected streaming platform	Refer to the platforms from the <i>Available Default Platforms</i> and <i>Available Custom Platforms</i> fields
Current Server	Read/Write	The current server for the streaming platform	Server is dependent on selected Current Platform
Current Quality Level	Read/Write	The current streaming quality level	Quality level is dependent on selected Current Platform
Stream Key	Read/Write	The stream key for the streaming platform	String
Password	Read/Write	The passphrase for an encrypted SRT stream	String
Current URL	Read/Write	The current URL for the streaming platform. This field is writable if <i>Customizable URL</i> field is true.	String
Customizable URL	Read only	A boolean specifying whether custom URLs are supported by the streaming platform	true - Custom URLs are supported false - Custom URLs are not supported
Available Default Platforms	Read only	The available default streaming platforms	Comma separated list of default platforms
Available Custom Platforms	Read only	The custom streaming platforms loaded in the Web Presenter	Comma separated list of custom platforms
Available Servers	Read only	The available servers for the selected streaming platform	Comma separated list of servers
Available Quality Levels	Read only	The available quality levels for the selected streaming platform	Comma separated list of quality levels

Changing Stream Settings

The stream settings can be changed by providing a stream settings block. The following is an example of streaming a 1080p59.94 input on Twitch with a medium stream quality.

```

STREAM SETTINGS:↵
Video Mode: 1080p59.94↵
Current Platform: Twitch↵
Current Server: US West: Los Angeles, CA↵
Current Quality Level: Streaming Medium↵
Stream Key: live_123456789_1aB2cD3eF4gH5iJ6kL7mN8oP9qR0sT↵
↵
ACK↵
↵
STREAM SETTINGS:↵
Video Mode: 1080p59.94↵
Current Platform: Twitch↵
Current Server: US West: Los Angeles, CA↵
Current Quality Level: Streaming Medium↵
Stream Key: live_123456789_1aB2cD3eF4gH5iJ6kL7mN8oP9qR0sT↵
↵

```

Stream XML Block

The stream XML block allows users to configure the Web Presenter with a custom configuration file in XML format.

Block syntax

The following example shows an XML file - Custom.xml has been loaded to configure the stream settings in the Web Presenter.

```
STREAM XML:↵  
Files: Custom.xml↵  
↵
```

Parameters

Key	Read/Write	Description	Valid Values
Files	Read/Write	The XML files loaded in Web Presenter	Comma separated list of filenames
Action	Write only	The stream XML action	Remove Remove All"

Adding a Stream XML file

An XML file can be loaded onto a Web Presenter by sending the stream xml command with a filename, then provide the contents of the XML file. After adding the XML file, the Available Custom Platforms field in the STREAM SETTINGS block will be updated with the new platforms, however the Current items will remain unchanged.

For the Stream XML block to be parsed correctly, any blank lines should be removed from the XML files.

Refer to the `Blackmagic Stream XML File Format` section in this manual for description of the Stream XML file format.

```
STREAM XML Custom.xml:↵  
<?xml version="1.0" encoding="UTF-8"?>↵  
<streaming>↵  
    <service>↵  
        <name>My Custom Platform</name>↵  
        ...  
    </service>↵  
</streaming>↵  
↵  
ACK↵  
↵  
STREAM XML Custom.xml:↵  
<?xml version="1.0" encoding="UTF-8"?>↵  
<streaming>↵  
    <service>↵  
        <name>My Custom Platform</name>↵  
        ...  
    </service>↵  
</streaming>↵  
↵
```

```
STREAM XML:↵
Files: Custom.xml↵
↵
STREAM SETTINGS:↵
Available Custom Platforms: My Custom Platform↵
↵
```

Removing a Stream XML file

An XML file can be removed from the Web Presenter by sending the stream xml command with the remove action.

```
STREAM XML:↵
Action: Remove↵
Files: Custom.xml↵
↵
ACK↵
↵
STREAM XML:↵
Files:↵
↵
STREAM SETTINGS:↵
Available Custom Platforms:↵
↵
```

Removing all Stream XML files

All XML files can be removed from the Web Presenter by sending the stream xml command with the remove all action. In the example, following the remove all action, the loaded stream XML files and available custom platforms are both displayed as empty.

```
STREAM XML:↵
Action: Remove All↵
↵
ACK↵
↵
STREAM XML:↵
Files: ↵
↵
STREAM SETTINGS:↵
Available Custom Platforms:↵
↵
```

Stream State Block

The stream state block provides the streaming status of the Web Presenter.

The Web Presenter server will send a stream state block update whenever there is a change to the Status field. Due to frequency of changes to Duration, Bitrate and Cache Used fields, these fields need to be polled by the client by requesting a Stream State block.

Block syntax

```
STREAM STATE:↵↵
Status: Idle↵↵
Bitrate: 161672↵↵
Duration: 00:00:00:00↵↵
Cache Used: 0↵↵
↵↵
```

Parameters

Key	Read/Write	Description	Valid Values
Status	Read only	The stream state of the Web Presenter, updated when the stream status changes	Idle Connecting Streaming Interrupted
Action	Write only	The Web Presenter stream state action.	Start Stop
Duration	Read only	The duration of the active stream	String in format of DD:HH:MM:SS
Bitrate	Read only	The bitrate of the active stream	Integer bits per second
Cache Used	Read only	The current usage of the streaming cache	Integer as a percentage

Starting Stream

The stream is started by providing a stream state block with start action.

```
STREAM STATE:↵↵
Action: Start↵↵
↵↵
ACK↵↵
↵↵
STREAM STATE:↵↵
Status: Connecting↵↵
↵↵
STREAM STATE:↵↵
Status: Streaming↵↵
↵↵
```

Stopping stream

The stream is stopped by providing a Stream State block with stop action.

```
STREAM STATE:↵↵
Action: Stop↵
↵
ACK↵
↵
STREAM STATE:↵↵
Status: Idle↵
↵
```

Audio Settings Block

The Audio Settings block contains the audio configuration for the connected Web Presenter.

Block syntax

This example shows the output for a connected Web Presenter. The stream settings prefixed with Current show the active audio settings and are writable. The stream settings prefixed by Available show the available audio settings for the device or platform and are read-only.

```
AUDIO SETTINGS:↵↵
Current Monitor Out Audio Source: Auto↵
Available Monitor Out Audio Sources: Auto, SDI In, Remote Source↵
↵
```

Parameters

Key	Read/Write	Description	Valid Values
Current Monitor Out Audio Source	Read/Write	The current audio source on the monitor output	Refer to the audio sources from the <i>Available Monitor Out Audio Sources</i> field
Available Monitor Out Audio Sources	Read only	The available audio sources that can be routed to the monitor output	Comma separated list of audio sources

Changing Audio Settings

The audio settings can be changed by providing an audio settings block. The following is an example of setting the monitor output audio source to remote.

```
AUDIO SETTINGS:↵↵
Current Monitor Out Audio Source: Remote Source↵
↵
ACK↵
↵
AUDIO SETTINGS:↵↵
Current Monitor Out Audio Source: Remote Source↵
↵
```

Shutdown Block

The Shutdown block provides power control of the Web Presenter. The Shutdown block is write-only and not presented in the preamble.

Parameters

Key	Read/Write	Description	Valid Values
Action	Write only	The Web Presenter shutdown action.	Reboot Factory Reset

Reboot

The Web Presenter can be rebooted by providing a Shutdown block with reboot action.

```
SHUTDOWN:↵
```

```
Action: Reboot↵
```

```
↵
```

```
ACK↵
```

```
↵
```

On reboot action, the Web Presenter server will be stopped and clients will be disconnected.

Factory Reset

The Web Presenter can be factory reset by providing a Shutdown block with factory reset action. On factory reset action, all settings are set to factory defaults.

```
SHUTDOWN:↵
```

```
Action: Factory Reset↵
```

```
↵
```

```
ACK↵
```

```
↵
```

Blackmagic Streaming XML Format

Overview

The Blackmagic Streaming XML allows users to specify streaming services in addition to the default services provided by the Web Presenter.

The Streaming XML can be loaded into the Web Presenter with Web Presenter Setup. Refer to the 'Using Web Presenter Setup' section earlier in this manual

The Streaming XML can also be loaded by copying the contents into the Stream XML block with the Blackmagic Web Presenter Ethernet Protocol.

The following is a minimal example of a Streaming XML file:

```
<?xml version="1.0" encoding="UTF-8"?>
<streaming>
  <service>
    <name>My Streaming Service</name>
    <servers>
      <server>
        <name>My Streaming Server</name>
        <url>rtmp://my.streaming-server.com/live</url>
      </server>
    </servers>
    <profiles>
      <profile>
        <name>My Streaming Quality</name>
        <config resolution="1080p" fps="60" codec="H264">
          <bitrate>7500000</bitrate>
        </config>
      </profile>
    </profiles>
  </service>
</streaming>
```

Streaming XML Definition

The Streaming XML file follows standard XML format and shall begin with XML declaration.

```
<?xml version="1.0" encoding="UTF-8"?>
```

Streaming Element

The Streaming XML file shall be contained by the <streaming> element. The <streaming> element will consist of 1 or more <service> child elements.

The following is an example of a <streaming> element block that defines 2 streaming services.

```
<streaming>
  <service>
    <name>Service 1</name>
    <!-- Streaming settings for "Service 1" -->
  </service>
  <service>
    <name>Service 2</name>
    <!-- Streaming settings for "Service 2" -->
  </service>
</streaming>
```

Service Element

The <service> element provides a description of the streaming service. If multiple streaming services are used, it is possible to define multiple <service> elements within each <streaming> element block.

The following is an example of a <service> element block in the Stream XML file.

```
<streaming>
  <service customizable-url="true">
    <name>My Streaming Service</name>
    <key>abc1-def2-ghi3-jkl4-mno5</key>
    <servers>
      <!-- Streaming server settings -->
    </servers>
    <profiles default="Streaming High">
      <!-- Streaming quality settings-->
    </profiles>
    <credentials>
      <!-- Streaming username and password settings -->
    </credentials>
  </service>
  <!-- <service> elements blocks for other streaming services -->
</streaming>
```

Attributes

Attribute	Optional/Required	Description
customizable-url	Optional	The service supports specifying custom URLs - supported = "true" or unsupported = "false" (default)

Child Elements

Element	Optional/Required	Description
<name>	Required	The name of the streaming service
<key>	Optional	The stream key for the streaming service
<servers>	Optional	The RTMP/SRT server settings of the streaming service (see below). May be omitted if customizable-url is true.
<profiles>	Required	The quality settings of the streaming service (see below)
<credentials>	Optional	The username and password of the streaming service (see below)

Servers Element

The <servers> element consists of 1 or more <server> child elements for defining the streaming server(s). The <servers> element is a required child of the <service> element. Defining multiple servers allows specifying localized and/or backup servers within a single XML description

The following is an example of a <servers> element block that defines a primary and secondary URL for the SRT server.

```
<service>
  ...
  <servers>
    <server group="Primary">
      <name>My Streaming Service Server</name>
      <url>srt://srt.my-streaming-service.com:2010</url>
      <srt-extensions>
        ...
      </srt-extensions>
    </server>
    <server group="Secondary">
      <name>My Streaming Service Backup Server</name>
      <url>srt://srt-backup.my-streaming-service.com:2010</url>
      <srt-extensions>
        ...
      </srt-extensions>
    </server>
    <!-- Additional <server> element blocks defining other
servers for streaming service -->
  </servers>
  ...
</service>
```

Attributes

Attribute	Optional/Required	Description
group	Optional	The logical grouping for the server

Child Elements

Element	Optional/Required	Description
<name>	Required	The name of the RTMP/SRT streaming server
<url>	Required	The URL of the RTMP/SRT streaming server
<srt-extensions>	Optional	Extended service block specific to SRT streaming server (see below)

SRT Extensions Element

The <srt-extensions> element consists of 1 or more child elements that define SRT specific parameters.

The following is an example of a <srt-extensions> element block for a primary stream identifier.

```
<service>
  ...
  <servers>
    <server group="Primary">
      ...
      <srt-extensions>
        <stream-id>
          <item key="copy" value="0"/>
        </stream-id>
      </srt-extensions>
    </server>
  </servers>
  ...
</service>
```

Child Elements

Element	Optional/Required	Description
<stream-id>	Required	Provides element with custom parameters for the stream ID. Each child element of stream-id has 1 or more item elements with a key/value pair.

Profiles Element

The <profiles> element consists of 1 or more <profile> child elements that define streaming quality. The <profiles> element is a required child of the <service> element. Defining multiple profiles allows specifying custom bitrates for different streaming qualities.

The following is an example of a <profiles> element block that defines 3 profiles.

```
<service>
  ...
  <profiles default="Streaming High">
    <profile>
      <name>Streaming High</name>
      <!-- Define <config> elements to specify target
bitrates for Streaming High profile -->
    </profile>
    <profile>
      <name>Streaming Medium</name>
      <!-- Define <config> elements to specify target
bitrates for Streaming Medium profile -->
    </profile>
  </profiles>
  ...
</service>
```

Attributes

Attribute	Optional/Required	Description
default	Optional	The name of the default profile

Child Elements

Element	Optional/Required	Description
<name>	Required	The name of the profile
<config>	Required	Video mode dependent quality settings for profile (see below)

Config Element

The <config> element defines a mapping between the video resolution and frame rate and the target bitrate for the quality level. The <config> element is a child of the <profile> element.

The following is an example of a <config> element block for setting the target bitrate for a high quality stream with 720p60 and 1080p60 video inputs.

```
<profile>
  <name>Streaming High</name>
  <config resolution="720p" fps="60" codec="H264">
    <bitrate>6000000</bitrate>
    <audio-bitrate>128000</audio-bitrate>
  </config>
  <config resolution="1080p" fps="60" codec="H264">
    <bitrate>8000000</bitrate>
    <audio-bitrate>128000</audio-bitrate>
  </config>
  <!-- <config> elements for other resolutions and frame rates -->
</profile>
```

Attributes

Attribute	Optional/Required	Description
resolution	Required	The resolution of the streaming video mode
fps	Required	The frame rate of the streaming video mode (frames per second)
codec	Optional	The codec for encoding the streaming video - "H264" (default) or "H265"

Child Elements

Element	Optional/Required	Description
<bitrate>	Required	The target bitrate of the streaming video (bits per second)
<audio-bitrate>	Optional	The target bitrate of the streaming audio (bits per second)

The supported streaming quality bitrates can be found in section `Using Web Presenter Setup` section earlier in this manual.

TIP For each <config> element block, choose a maximum resolution and fps to cover all video modes for the target bitrate. For example, defining a <config> element with resolution="1080p" and fps = "30" will apply for video modes 1080p23.98, 1080p24, 1080p25, 1080p29.97 and 1080p30.

For audio bitrate, only 128 Kb/s is supported.

Credentials Element

The <credentials> element allows specifying an RTMP session username and password if required by the service. The <credentials> element is an optional child to service element.

The following is an example of a <credentials> element block that defines a username and password for the streaming service.

```
<service>
  ...
  <credentials>
    <username>myusername</username>
    <password>abcd1234</password>
  </credentials>
  ...
</service>
```

Child Elements

Element	Optional/Required	Description
<username>	Required	RTMP session username
<password>	Required	RTMP/SRT session password

Ajuda

Obtendo Ajuda

A maneira mais rápida de obter ajuda é visitando as páginas de suporte online da Blackmagic Design e consultando os materiais de suporte mais recentes disponíveis para seu Blackmagic Web Presenter.

Páginas de Suporte Técnico Online Blackmagic Design

Os manuais mais recentes podem ser encontrados na Central de Suporte Técnico da Blackmagic Design em www.blackmagicdesign.com/br/support

Fórum Blackmagic Design

O fórum da Blackmagic Design no nosso site é um recurso útil que você pode acessar para obter mais informações e ideias criativas. Também pode ser uma maneira mais rápida de obter ajuda, pois já podem existir respostas de outros usuários experientes e da equipe da Blackmagic Design, o que o ajudará a seguir em frente. Você pode visitar o fórum em <https://forum.blackmagicdesign.com>

Contatar o Suporte Blackmagic Design

Caso não encontre a ajuda que precisa no nosso material de suporte ou no fórum, por favor use o botão “Envie-nos um email” na página de suporte para nos encaminhar uma solicitação de suporte. Como alternativa, clique no botão “Encontre sua equipe de suporte local” na página de suporte e ligue para a sua central de assistência técnica Blackmagic Design mais próxima.

Informações Regulatórias



Descarte de Resíduos de Equipamentos Elétricos e Eletrônicos na União Europeia

O símbolo no produto indica que este equipamento não pode ser eliminado com outros materiais residuais. Para descartar seus resíduos de equipamento, ele deve ser entregue a um ponto de coleta designado para reciclagem. A coleta separada e a reciclagem dos seus resíduos de equipamento no momento da eliminação ajudarão a preservar os recursos naturais e a garantir que sejam reciclados de uma maneira que proteja a saúde humana e o meio ambiente. Para mais informações sobre onde você pode eliminar os resíduos do seu equipamento para reciclagem, por favor entre em contato com a agência de reciclagem local da sua cidade ou o revendedor do produto adquirido.



Este equipamento foi testado e respeita os limites para um dispositivo digital Classe A, conforme a Parte 15 das normas da FCC. Esses limites foram criados para fornecer proteção razoável contra interferências nocivas quando o equipamento é operado em um ambiente comercial. Este equipamento gera, usa e pode irradiar energia de radiofrequência e, se não for instalado ou usado de acordo com as instruções, poderá causar interferências nocivas nas comunicações via rádio. A operação deste produto em uma área residencial pode causar interferência nociva, nesse caso o usuário será solicitado a corrigir a interferência às suas próprias custas.

A operação está sujeita às duas condições a seguir:

- 1 Este dispositivo não poderá causar interferência nociva.
- 2 Este dispositivo deve aceitar qualquer interferência recebida, incluindo interferência que possa causar uma operação indesejada.



R-R-BMD-20201201001
R-R-BMD-20201201002

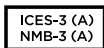

Norma Canadense ISED

Este dispositivo cumpre com as exigências canadenses para aparelhos digitais de classe A.

Quaisquer modificações ou utilização deste produto fora dos limites previstos poderão anular a conformidade com estas normas.

A conexão com interfaces HDMI devem ser feitas com cabos HDMI protegidos.

Este equipamento foi testado para fins de cumprimento com a sua utilização pretendida em um ambiente comercial. Se o equipamento for usado em um ambiente doméstico, ele poderá causar interferência radioelétrica.

Informações de Segurança

Este equipamento deve ser conectado a uma tomada com uma conexão à terra protegida.

Para reduzir o risco de choque elétrico, não exponha este equipamento a gotejamento ou respingo.

Este equipamento é adequado para uso em locais tropicais com uma temperatura ambiente de até 40 °C.

A faixa de temperatura de armazenamento é de -20 °C a 60 °C e umidade relativa de 0% a 90% sem condensação.

Certifique-se de que ventilação adequada seja fornecida ao redor do produto e não esteja restrita.

Ao montar o produto em rack, certifique-se de que a ventilação não esteja restringida por equipamentos adjacentes.

Não há componentes em seu interior reparáveis pelo operador. Solicite o serviço de manutenção à assistência técnica local da Blackmagic Design.



Utilize apenas em altitudes inferiores a 2000 m acima do nível do mar.

Declaração para o Estado da Califórnia

Este produto pode expô-lo a produtos químicos, tais como vestígios de bifenilos polibromados dentro de peças de plástico, que é conhecido no estado da Califórnia por causar câncer e defeitos congênitos ou outros danos reprodutivos.

Para mais informações, visite www.P65Warnings.ca.gov.

Garantia

36 Meses de Garantia Limitada

A Blackmagic Design garante que o Blackmagic Web Presenter estará livre de defeitos de materiais e fabricação por um período de 36 meses a partir da data de compra, excluindo conectores, cabos, módulos de fibra óptica, fusíveis e baterias que estarão livres de defeitos de materiais e fabricação por um período de 12 meses a partir da data de compra. Se o produto se revelar defeituoso durante este período de garantia, a Blackmagic Design, a seu critério, consertará o produto defeituoso sem cobrança pelos componentes e mão-de-obra, ou fornecerá a substituição em troca pelo produto defeituoso.

Para obter o serviço sob esta garantia, você, o Consumidor, deve notificar a Blackmagic Design do defeito antes da expiração do período de garantia e tomar as providências necessárias para o desempenho do serviço. O Consumidor é responsável pelo empacotamento e envio do produto defeituoso para um centro de assistência designado pela Blackmagic Design com os custos de envio pré-pagos. O Consumidor é responsável pelo pagamento de todos os custos de envio, seguro, taxas, impostos e quaisquer outros custos para os produtos que nos forem devolvidos por qualquer razão.

Esta garantia não se aplica a defeitos, falhas ou danos causados por uso inadequado ou manutenção e cuidado inadequado ou impróprio. A Blackmagic Design não é obrigada a fornecer serviços sob esta garantia: a) para consertar danos causados por tentativas de instalar, consertar ou fornecer assistência técnica ao produto por pessoas que não sejam representantes da Blackmagic Design, b) para consertar danos causados por uso ou conexão imprópria a equipamentos não compatíveis, c) para consertar danos ou falhas causadas pelo uso de componentes ou materiais que não são da Blackmagic Design, d) para fornecer assistência técnica de um produto que foi modificado ou integrado a outros produtos quando o efeito de tal modificação ou integração aumenta o tempo ou a dificuldade da assistência técnica do serviço. ESTA GARANTIA É FORNECIDA PELA BLACKMAGIC DESIGN NO LUGAR DE QUAISQUER OUTRAS GARANTIAS, EXPLÍCITAS OU IMPLÍCITAS. A BLACKMAGIC DESIGN E SEUS FORNECEDORES NEGAM QUAISQUER GARANTIAS IMPLÍCITAS DE COMERCIALIZAÇÃO OU ADEQUAÇÃO A UMA FINALIDADE ESPECÍFICA. A RESPONSABILIDADE DA BLACKMAGIC DESIGN DE REPARAR OU SUBSTITUIR PRODUTOS DEFEITUOSOS É O ÚNICO E EXCLUSIVO RECURSO FORNECIDO AO CLIENTE PARA QUAISQUER DANOS INDIRETOS, ESPECIAIS, INCIDENTAIS OU CONSEQUENTES INDEPENDENTEMENTE DE A BLACKMAGIC DESIGN OU O FORNECEDOR TEREM SIDO AVISADOS PREVIAMENTE SOBRE A POSSIBILIDADE DE TAIS DANOS. A BLACKMAGIC DESIGN NÃO É RESPONSÁVEL POR QUAISQUER USOS ILEGAIS DO EQUIPAMENTO PELO CONSUMIDOR. A BLACKMAGIC NÃO É RESPONSÁVEL POR QUAISQUER DANOS CAUSADOS PELO USO DESTE PRODUTO. O USUÁRIO DEVE OPERAR ESTE PRODUTO POR CONTA E RISCO PRÓPRIOS.

© Direitos autorais 2023 Blackmagic Design. Todos os direitos reservados. 'Blackmagic Design', 'DeckLink', 'HDLink', 'Workgroup Videohub', 'Multibridge Pro', 'Multibridge Extreme', 'Intensity' e 'Leading the creative video revolution' são marcas comerciais registradas nos Estados Unidos e em outros países. Todos os outros nomes de empresas e produtos podem ser marcas comerciais de suas respectivas empresas com as quais elas são associadas.

Thunderbolt e o logotipo Thunderbolt são marcas registradas da Intel Corporation nos Estados Unidos e/ou em outros países.

Eylül 2023

Kurulum ve Kullanım Kılavuzu

Blackmagicdesign 

Blackmagic Web Presenter



Blackmagic Web Presenter



Hoş Geldiniz

Blackmagic Web Presenter ürünümüzü satın aldığınız için teşekkür ederiz!

Blackmagic Web Presenter tüm SDI ekipmanlara doğrudan bağlanır, sinyali H.264 formatına dönüştürür ve YouTube Live, Facebook Live ve Twitch gibi, popüler internet yayın servisleri üzerinden internette yayınlanmanızı mümkün kılar. Ayrıca, isteğe bağlı bir ATEM Streaming Bridge kullanarak yayın kalitesindeki video sinyalini bir noktadan başka bir noktaya gönderebilirsiniz. Bu, interneti kullanarak profesyonel video sinyallerini uzaktaki konumlara aktarmayı kolaylaştırır!

Bu kullanım kılavuzu, Blackmagic Web Presenter'i kullanmaya başlamanız için bilmeniz gereken her şeyi ve YouTube Live, Facebook Live, Twitch, Zoom, Skype ve başka platformlar için gereken tüm ayarları nasıl düzenleyeceğiniz dahil, tüm özellikleri ve kontrolleri nasıl kullanacağınızı açıklar.

Bu kullanım kılavuzunun en güncel versiyonunu ve Blackmagic Web Presenter cihazının dahili yazılımı için güncellemeleri indirmek üzere, www.blackmagicdesign.com/tr adresindeki destek sayfamızı kontrol edin. Yeni yazılımlar piyasaya sürüldüğünde size duyurabilmemiz için, bilgisayarınıza yazılımı indirirken bilgilerinizi sitemize kaydettiğinizden emin olunuz.

Yeni özellikler ve geliştirmeler üzerinde sürekli çalıştığımızdan, yorumlarınızı iletmeniz bizim için önemlidir!

Grant Petty

Blackmagic Design CEO

İçindekiler

Başlarken	535
Web Presenter'in Ön Panelinin Kullanımı	538
LCD Ekran	539
Monitör Çıkışının Kullanılması	540
Web Presenter Setup Yazılımının Kullanımı	545
Canlı İnternet Yayını Sekmesi	546
Ayarlar Sekmesi	549
Ağ Ayarları	550
İnternet Paylaşımının Doğrudan İnternet Yayını için Ayarlanması	550
Akıllı Telefonunuzu Kullanarak İnternet Yayını	551
Blackmagic Web Presenter'in bir Web Kamerası Olarak Kullanımı	551
Open Broadcaster Uygulamasının Kurulumu	551
ATEM Streaming Bridge ile Video Bağlantılarının Oluşturulması	554
XML Dosyasının Oluşturulması	555
XML Dosyasını Dışa Aktarma	555
Tally, Talkback ve Kamera Kontrolü	556
URSA Broadcast G2'nin Bağlanması	557
Blackmagic Universal Rack Shelf	558
Ürün İçeriği	558
Bir Cihazın Ekipman Rafına Monte Edilmesi	559
1/6 Genişliğindeki Kapatma Panelinin Takılması	559
1/3 Genişliğindeki Yan Kapatma Panelinin Takılması	559
Dahili Yazılımın Güncellenmesi	560
Developer Information	561
Blackmagic Web Presenter Ethernet Protocol	561
Protocol Blocks	563
Blackmagic Streaming XML Format	574
Overview	574
Streaming XML Definition	574
Yardım	581
Mevzuata İlişkin Bildirimler	582
Güvenlik Bilgileri	583
Garanti	584

Başlarken

Blackmagic Web Presenter ile çalışmaya başlamak çabuk ve kolay! Yapmanız gereken tek şey; güç kablosunu prize takmak, video ve sesi bağlamak, cihazı bilgisayarınıza bağlamak ve ardından internete bağlanmaktır.

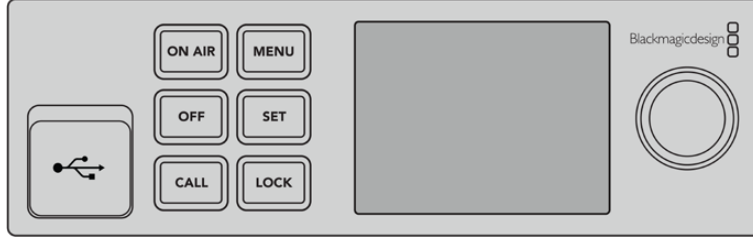

Blackmagic Web Presenter ön panel

Güç Kablosunun Takılması

Blackmagic Web Presenter cihazınızın arka panelindeki güç girişine standart bir IEC güç kablosu takın.

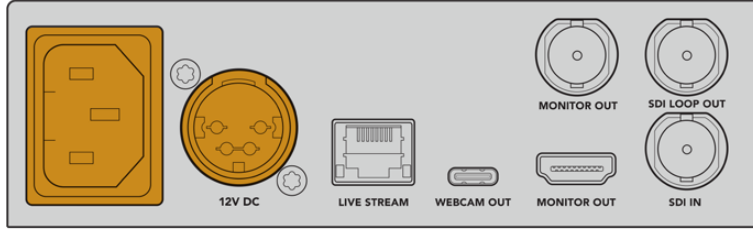

Blackmagic Web Presenter, IEC veya 12V DC güç girişi üzerinden çalıştırılabilir

Web Presenter'de yedek bir 12V DC güç girişi de vardır. Harici veya yedek güç kaynaklarını bağlamak istediğinizde, bir kesintisiz güç kaynağı veya harici 12V batarya gibi ekipmanlar için bu girişi kullanabilirsiniz.

Video ve Sesin Bağlanması

Video kaynağınızı, Blackmagic Web Presenter'in SDI girişine takın. Video bağlandığında, Web Presenter'inizin yerleşik LCD ekranında görüntülenir. Ses, video ile birlikte SDI video sinyaline gömülür ve LCD ekrandaki ses göstergelerini izleyerek bunu doğrulayabilirsiniz.

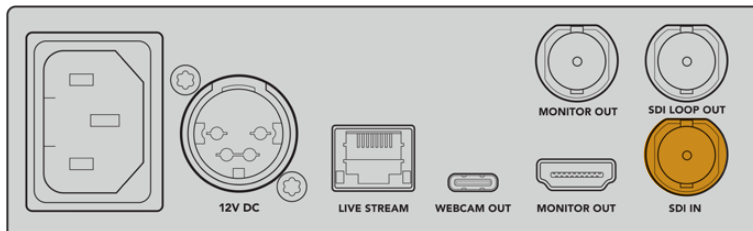

Blackmagic Web Presenter'inizin SDI girişine video sinyali bağlayın

Blackmagic Web Presenter, 12G-SDI standardını destekler ve video giriş sinyali değiştiğinde, 2160p60'a kadar tüm HD ve Ultra HD formatları arasında otomatik olarak değişir. Blackmagic Web Presenter 4K, Ultra HD'de yayın yapabilirken Blackmagic Web Presenter HD, neredeyse her türlü video sinyalini alır ve 1080p'ye dönüştürür.

Bir Monitörün Bağlanması

HDMI televizyonunuzu veya SDI monitörünüzü, monitör çıkışlarından birine takın. Bu, yayınızı izlemenize ve video yayınızla birlikte sürekli güncellenen önemli durum bilgilerini izlemenize olanak verir. Monitör çıkışını nasıl kullanacağınız hakkında daha fazla bilgi için, 'Monitör Çıkışının Kullanımı' başlıklı bölüme bakınız.

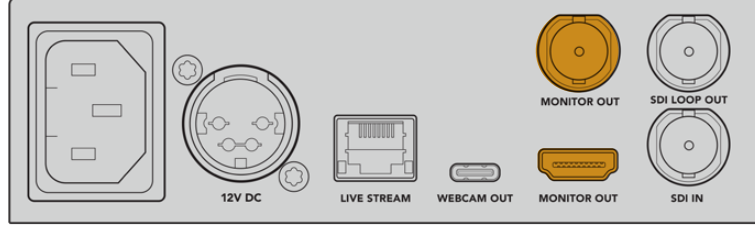

Web Presenter'inizin monitör çıkışına bir monitör bağlayın

USB Üzerinden Bilgisayara Bağlanma

Web Presenter'in ön veya arka panelindeki USB-C portunu kullanarak cihazı bilgisayarınıza bağlayın. Blackmagic Web Presenter Setup yardımcı yazılımı ile yapılandırmak ve üniteyi güncellemek için bu USB portlar kullanılır. Web Presenter'inizi yapılandırdıktan hemen sonra, cihazla bilgisayarınız arasındaki bağlantıyı kesebilirsiniz.

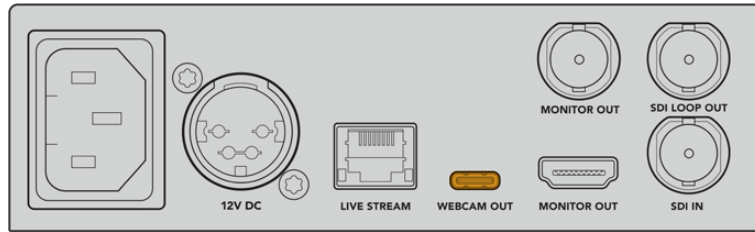

Ön veya arka paneldeki USB-C portu kullanarak Blackmagic Web Presenter'in bilgisayarınıza bağlanması.

İnternete Bağlanma

Blackmagic Web Presenter cihazınızı, 'canlı internet yayını'nın yapıldığı Ethernet portundan bir internet yönlendiricisine veya bir ağ anahtarına bir ağ kablosu takarak internete bağlayın.

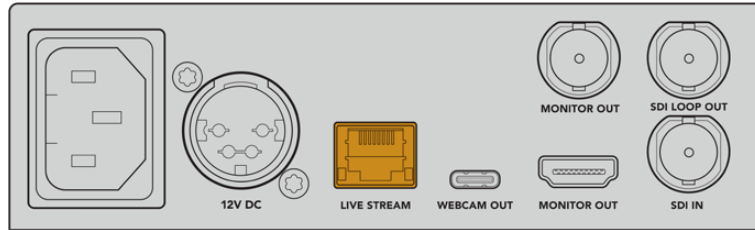

Arka paneldeki Ethernet portu kullanarak Blackmagic Web Presenter'in internet ağına bağlanması.

Canlı İnternet Yayını Ayarlarının Yapılması

Artık Web Presenter'inizi; YouTube Live, Facebook Live ve Twitch gibi bir internet yayın platformu üzerinden internet yayını yapmak için ayarlayabilirsiniz. Bu örnekte, YouTube Live üzerinden bir internet yayınının ayarlarını yapacağız.

- 1 YouTube Studio hesabınızdan temin edeceğiniz internet yayın şifrenizi kopyalayın.
- 2 www.blackmagicdesign.com/tr/support adresinden Blackmagic Web Presenter Setup yardımcı yazılımını indirin ve bilgisayarınıza yükleyin. Bu yazılım, internet yayın ayarlarınızı ilk kez yapılandırırken kullanılır.
- 3 Blackmagic Web Presenter Setup yardımcı yazılımını başlatın ve 'canlı internet yayını' sayfasına girin.
- 4 Platformu YouTube olarak ve sunucuyu da 'primary' (ana) olarak ayarlayın. 'Yayın Şifresi' alanına YouTube internet yayın şifrenizi kopyalayın ve internet yayın kalitesini seçin. 'Kaydet' ibaresini tıklayın.
- 5 Artık, internet üzerinden dünyaya yayın yapmaya hazırsınız! Ekrandaki 'on air' butonunu tıklayın veya ünitenin ön panelindeki 'on air' butonuna basın. Yapımınız bittiğinde 'off' (kapat) butonuna basarak yayınızı sonlandırın.

SRT İnternet Yayın Protokolünün Kullanımı

Güvenli sağlam aktarım protokolü yani SRT, RTMP'ye kıyasla daha düşük gecikmeli internet yayını sağlar. SRT, şifreleme anahtarı gibi bir parola kullanarak güvenliği de artırır.

İnternet yayın hizmetinizin SRT protokol sürümünü seçerken, internet yayın hesabınızdan parolayı ve yayın şifresini kopyalayın ve Blackmagic Web Presenter Setup yardımcı yazılımının "şifre" ve "parola" alanlarına yapıştırın.

Live Stream

Platform: YouTube SRT (Beta) ▼

Server: Primary ▼

Key: 3ec3-qhu3-bp5f-2br1-11wj

Passphrase: pp-e000-3ec3-0369-2b19

Quality: Streaming Medium ▼

OFF ON AIR

Parolanızı kurulum yardımcı yazılımının "parola" alanına yapıştırın

Teknik açıdan deneyimli yayıncılar, internet yayın ayarlarını kişiselleştirmek isterse XML dosyasında hem RTMP veya SRT protokolü hem de H.264 veya H.265 kodeği değiştirilebilir. Daha fazla bilgi için "Blackmagic İnternet Yayını XML Formatı" bölümüne bakın.

Web Presenter'in Ön Panelinin Kullanımı

İnternet yayını başlatmak ve durdurmak ve ayarları değiştirmek için, Blackmagic Web Presenter'in ön panelindeki kontrolleri kullanın.

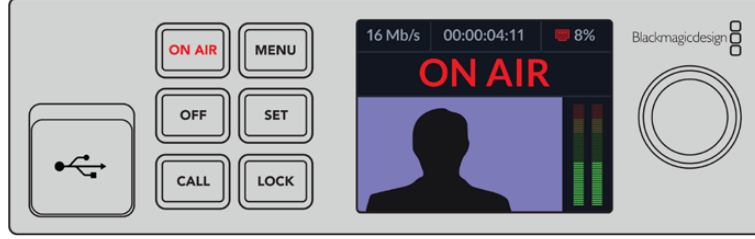

On Air - İnternet yayını başlatmak için 'on air' butonuna basın. İnternet yayını aktifken buton kırmızı renkte yanacaktır.

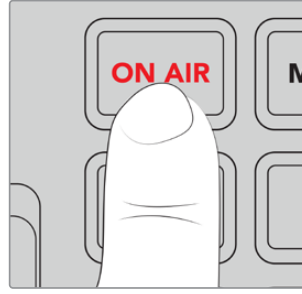

'On air' (Yayında) butonu yanıp sönüyorsa bu, canlı internet yayınının başlamadığını veya beklenmedik bir şekilde kesildiğini işaret eder. Bu, internet bağlantınızdan veya internet yayın ayarlarınızdan kaynaklanan bir sorun yüzünden olabilir. İnternet bağlantınızın çalıştığını ve internet yayın ayarlarınızın doğru olduğunu kontrol edin.

Off - İnternet yayını durdurmak için, 'off' butonuna basın.

Menu - LCD ekranda ayarları açmak için menü butonuna basın.

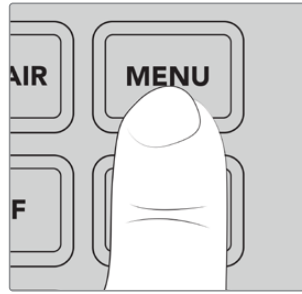

Bir ayarı değiştirmek için:

1 Değiştirmek istediğiniz ayarı seçmek için döner düğmeyi çevirin, sonra 'set' butonuna basın.

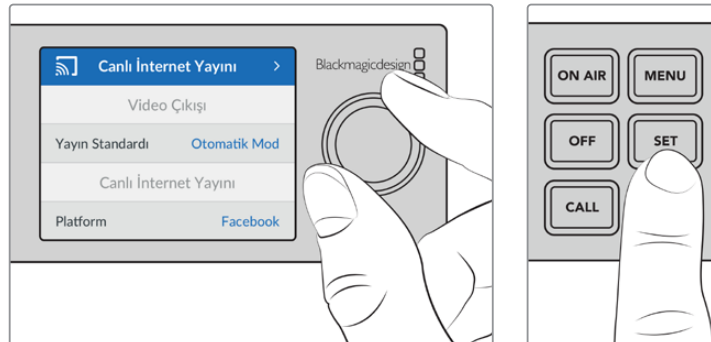

- 2 Ayarınızı deęiřtirmek için düęmeyi çevirin.
- 3 Deęiřiklięi onaylamak için, tekrar 'set' butonuna basın.

Menü öğeleri arasında geriye doęru gezinerek ana ekrana dönmek için menü butonuna basın.

Call - Bu özellik daha sonraki bir güncellemeyle etkinleřtirilecektir.

Lock - Paneli kilitlemek için bu butonu 1 saniye boyunca basılı tutun. Bu, butonları etkisiz kılarak, yanlışlıkla yayına girilmesini ya da bir internet yayınının yanlışlıkla durdurulmasını önler. Etkinken, bu buton kırmızı yanacaktır.

Panel kilidini açmak için butonu 2 saniye basılı tutun.

LCD Ekran

Web Presenter'i çalıştırdığınızda göreceğiniz ilk özellik, ana ekrandır. Ana ekran önemli bilgileri gösterir, bunlar arasında:

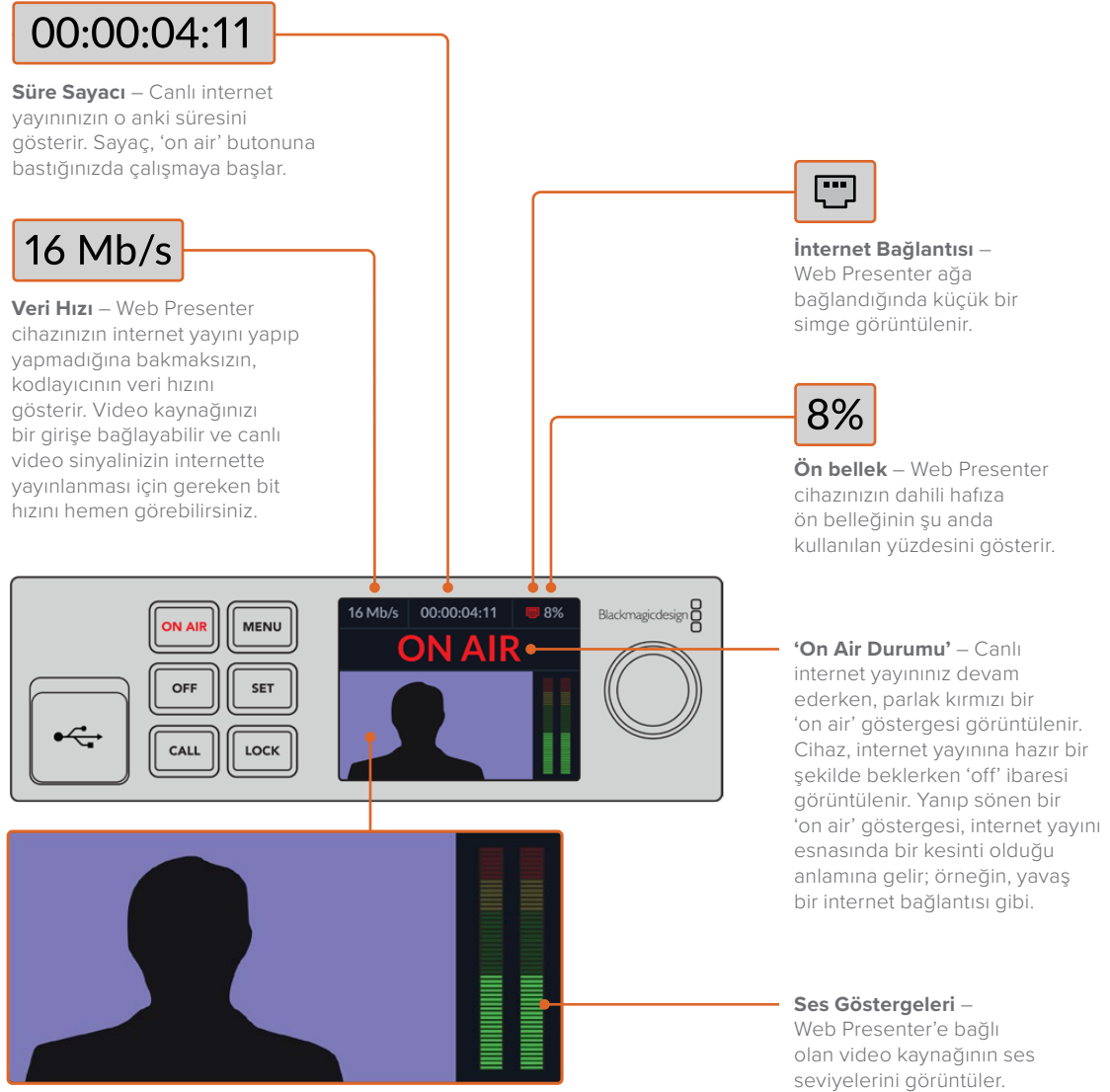

İnternet Bağlantı İkonları



Bir Ethernet kablosu bağlıyken mavi bir Ethernet ikonu görüntülenir ve internet yayını için Ethernet bağlantısı kullanılır.



Yayındayken ve Ethernet üzerinden internet yayını yapılırken, kırmızı bir Ethernet ikonu görüntülenir.



İnternet yayını için bir cep telefonunun internet bağlantısı paylaşıldığında, mavi bir cep telefonu ikonu görüntülenir.



İnternet bağlantısı paylaşılan bir cep telefonu üzerinden yayındayken ve internet yayını yaparken, kırmızı bir cep telefonu ikonu görüntülenir.

BİLGİ İkon görüntülenmediyse bu, Web Presenter cihazınızın ağa bağlı olmadığını işaret eder.

Monitör Çıkışının Kullanılması

Video girişini, ses seviyelerini, yayın durumunu, veri hızı ve önbellek değerlerinin yanı sıra, SDI girişine ilişkin teknik bilgileri takip etmenize monitör çıkışı imkan verir.



Blackmagic Web Presenter'deki monitör çıkışı, veri hızı ve önbellek durumu dahil kapsamlı bilgiler sunar

Monitör çıkış ekranı 8 panelden oluşur. Aşağıda, her bir panel ve görüntülediği bilgilere ilişkin bir tanım sunulmuştur.

Giriş Ekranı

Ana panel, bağlı olan SDI video kaynağından alınan o anki video girişini görüntüler.



On Air Durum Göstergesi

İnternet yayınına başlamadan önce, Web Presenter'in beklemede ve yayına hazır olduğunu bildirmek için yayın durum göstergesi, 'off' ibaresi görüntüler. İnternet yayını başladığında, yayın duruncaya kadar göstergede parlak kırmızı bir 'on air' (yayında) durumu görüntülenir.



On air göstergesinin altında süre sayacını bulacaksınız. Web Presenter'inizdeki 'on air' butonuna bastığınızda, süre sayacı çalışmaya başlar.

Web Presenter'iniz yayında değilse ama internet yayını, internet bağlantısını paylaşan bir cep telefonu üzerinden yapacaksa, 'off' (kapalı) göstergesinin köşesinde mavi bir cep telefonu simgesi belirir. Yayındayken, cep telefonu simgesi kırmızı yanar.

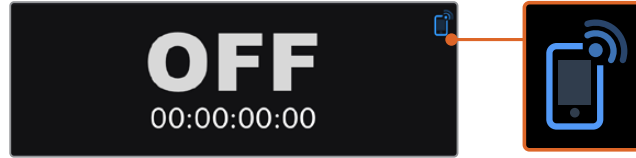

Canlı İnternet Yayını

Canlı internet yayını paneli, canlı internet yayın ayarlarınızın bilgilerini görüntüler. Bu bilgiler arasında; internet yayın platformu, sunucu ve protokol de bulunur. Bunlara ek olarak internet yayın çözünürlüğünü ve kalite ayarlarını da görüntüler.

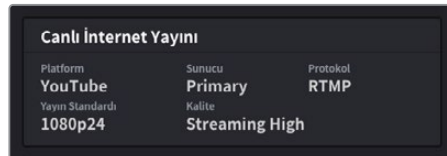

Video Girişi

Video girişi panelinin üst kısmındaki 5 küçük görüntüleyici, canlı internet yayınının en son 6 saniyesini gösterir, her bir görüntüleyici 1.2 saniyelik internet yayın süresini temsil eder.



Web Presenter'inizin SDI girişine bağlı video girişinin kaynağı hakkında, küçük görüntüleyicilerin altında ayrıntılı teknik bilgiler bulabilirsiniz.

Giriş Standardı	SDI video girişinin çözünürlüğünü ve kare hızını sergiler. Web Presenter, 2160p60'a kadar standartları destekler.
Renk Ölçümü	SDI video girişinin renk alanını gösterir. Web Presenter; Rec.601, Rec.709 ve Rec.2020 renk alanlarını destekler.
SDI Yardımcı Verileri	SDI video girişindeki video sinyaline ek olarak aktarılan verilere yardımcı veri denilir. Bunun içinde gömülü ses, zaman kodu ve kapalı alt yazılar vardır. SDI girişinizde yardımcı veri varsa 'Present' (mevcut) ibaresi görüntülenir.
Zaman Kodu	SDI video giriş kaynağından alınan zaman kodunu sergiler.
Kapalı Altyazılar	SDI video girişinizde Kapalı Altyazılar varsa formatı burada görüntülenir. CEA-608 ve CEA-708 formatları desteklenir.
SMPTE 292 CRC	Bu, SDI video için bir hata denetleme fonksiyonudur. Web Presenter cihazınız, SDI video girişinde bir sorun tespit ederse hata mesajı verir. CRC hataları genelde, arızalı bir SDI kablosu ya da çok uzun bir kablo sebebiyle oluşur.
Parlaklık Y Bit'leri ve Chroma Bit'leri	<p>Parlaklık y bit'leri' ve 'chroma bit'leri' göstergeleri SDI video giriş sinyalinin faaliyetlerini gösterir. Her bir harf, video sinyaline ait tek bir bit durumunu temsil eder.</p> <p>X - 'X' harfi, sürekli değişen bir bit değerini işaret eder.</p> <p>L - Düşük bit.</p> <p>H - Yüksek bit.</p> <p>Daha kolay anlaşılmasını sağlamak için SDI offset'leri çıkartılır. Örneğin, video siyah olduğunda tüm bit'ler düşüktür.</p> <p>Genelde, video sinyalindeki tüm bit'lerin sürekli değiştiğini işaret etmek üzere SDI video girişinizdeki 10 bit'in hepsi 'X' harfi ile gösterilir. SDI girişiniz 8 bitlik bir video ise en sağdaki iki bit her zaman 'L' ile gösterilecektir, çünkü hiçbir veri içermezler. 'X' sergilemesini beklediğiniz bir bit 'L' veya 'H' sergiliyorsa, bu 'stuck bit' (takılmış bit) olduğunu belirtir ve upstream videodaki bir arıza sonucunda olabilir.</p>

Ses Girişi

Ses girişi panelinin üst kısmındaki ses dalga şekli ekranı, canlı internet yayınının son 6 saniyesi için ses bilgilerini gösterir. Bu sürekli güncellenir ve sağdan sola doğru ilerler.

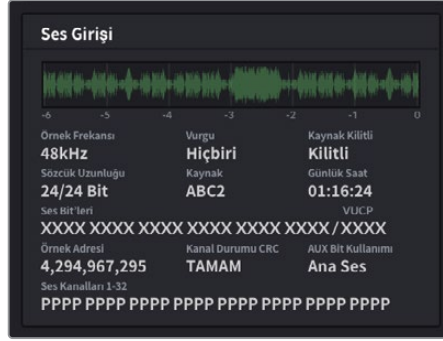

Ses dalga şekli ekranının altında, ses girişi hakkında detaylı teknik bilgileri görebilirsiniz.

Sample Frequency (Örnek Frekansı)	SDI girişindeki gömülü sesin örnek frekans hızını görüntüler.
Emphasis (Vurgu)	Ses kaynağınızın vurgu seçeneğinin etkinleştirilmiş olup olmadığını gösterir.
Audio Source Lock (Kaynak Kilidi)	Ses kaynağı frekansının harici bir referans kaynağına kilitli olup olmadığını gösterir.
Word Length	SDI girişinde gömülü olan sesin bit derinliğini gösterir.
Origin (Kaynak)	Bu dört karakter kanal kaynağını belirtir.
Time of Day (Kaynak Saati)	Serbest çalışan zaman kodu.
Audio Bits (Ses Bit'leri)	SDI bağlantısında gömülü olan ses örneklerinin bit faaliyetlerini gösterir. 16, 20 veya 24 bit ses alındığını ses kanal durumu belirtse bile, ses bit faaliyeti bunu teyit edecektir.
VUCP	VUCP bit'lerinin soldan sağa okunması: 'V' bit 'valid' (geçerli) bir bit belirtir, 'U' 'user' (kullanıcı) bit'idir, 'C' 'channel status' (kanal durumu) bit'i ve 'P' ise 'parity' (eşlik) bit'idir. Bu alan 'ses bit'leri' gibidir.
Sample Address (Örnek Adresi)	Ses örneği sayacı.
Aux Bit Kullanımı	Ana ses için AUX bit'lerinin kullanılıp kullanılmadığını belirtir.
Ses Kanalları 1-32	Her rakam SDI girişinde gömülü bir ses kanalını temsil eder. 'P' harfi bir ses kanalının kullanıldığını belirtir ve '-' işareti de kanalda bir ses sinyalinin olmadığı anlamına gelir.

Veri Hızı Ekranı

Veri hızı göstergesi, son 60 saniye boyunca kodlayıcının mevcut veri hızını gösterir. Veri hızı saniyede megabit olarak ölçülür. Bu gösterge, yayında değilken bile sürekli çalışır, böylece yayına girmeden önce bant genişliğini doğru ölçebilirsiniz.

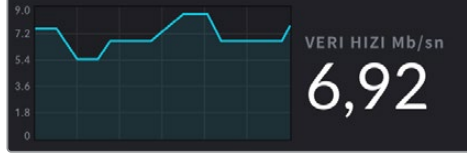

Ön Bellek Ekranı

Ön bellek ekranı, Web Presenter'inizin dahili arabelleğinin o an kullanılmakta olan yüzdesini gösterir ve grafik, son 60 saniye içinde kullanılan miktarı gösterir. Önbellek; program çıkışı sürekli kaydeden ve oynatan, küçük bir dahili bellek bölümüdür. İnternet yayın veri hızı, yayını devam ettirmek için gereken seviyenin altına düştüğünde, önbellek bir güvenlik önlemi işlevi görür.

İnternetin değişken yapısının, çoğunlukla ağ meşguliyeti veya kablosuz sinyal gücüne bağlı olması nedeniyle, internet yayın hızı azalırsa arabellek verisi de benzer şekilde yükselir. Bağlantı hızı video akışını destekleyemeyecek kadar yavaşlarsa bunu telafi etmek üzere, önbellek video karelerini depolayacaktır. Ancak, önbellek %100 dolduktan sonra video akışı riske girer, bu yüzden mümkün olan durumlarda önbelleğin dolmasının önüne geçin. İnternet yayını başlatmadan, bir video sinyalini bağlayıp monitör çıkışında önbellek ekranını izleyerek bir test uygulayabilirsiniz. Önbellek sık sık %100'e yaklaşırsa canlı internet yayın ayarlarında daha düşük bir kalite seçin.



Ses Göstergeleri

Ses göstergelerini kullanarak ses kaynağınızın seviyelerini denetleyebilirsiniz. Bunlar, seviyeleri PPM veya VU olarak göstermeleri için Web Presenter'in menü ayarlarından değiştirilebilirler. Ses seviyeleriniz çok yüksek olduğunda, göstergeler kırmızı yanar ve bu, canlı internet yayınızdaki sesin bozulabileceği ya da kırılacağı anlamına gelebilir. İdeal olarak ses sinyalinizi, yeşil bölümün üst kısmına yakın ve zaman zaman da sarı bölümde tutmaya çalışın.

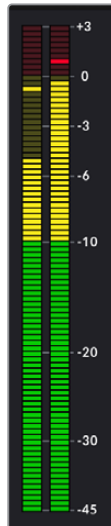

Web Presenter Setup Yazılımının Kullanımı

Blackmagic Web Presenter'iniz bir ağına bağlıyken, aynı ağa bağlı olan herhangi bir bilgisayar, Web Presenter'i uzaktan kontrol etmek için kullanılabilir. Blackmagic Web Presenter Setup ile cihazın ön panelinde bulunan kontrollerin ve ayarların aynısına erişebilirsiniz.

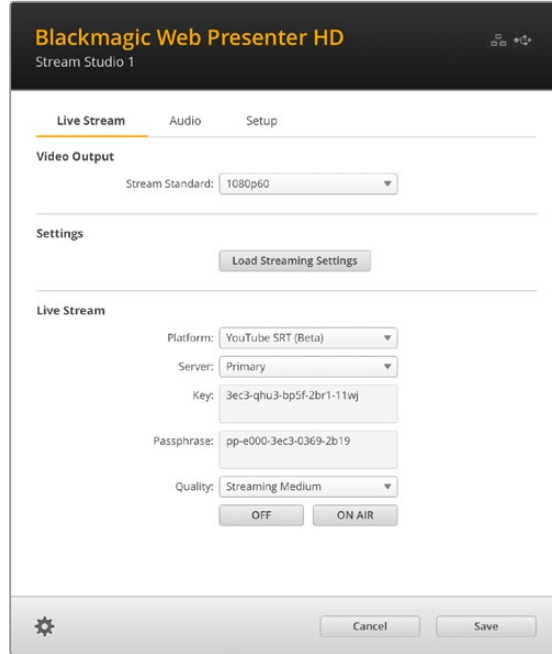

Canlı İnternet Yayını Sekmesi

Video Çıkışı

İnternet Yayın Standardı

İnternet yayınınızın video çözünürlüğünü seçmek için 'internet yayın standardı' menüsünü tıklayın. Kullandığınız Web Presenter modeline göre, 720p25'den 1080p60'a kadar bir seçim yapabilirsiniz.

Ayarlar

Özel internet yayın ayarlarınız varsa örneğin, bir Blackmagic ATEM Streaming Bridge cihazından alınan bir XML dosyası gibi, 'load streaming settings' (internet yayın ayarlarını yükle) ibaresini tıklayarak onları içe aktarabilirsiniz.

ATEM Streaming Bridge cihazına bağlanmak ve özel ayarlar oluşturmak hakkında daha fazla bilgi için 'ATEM Streaming Bridge ile Video Bağlantılarının oluşturulması' başlıklı bölüme bakın.

Canlı İnternet Yayını

Platform

Yayınınız için internet yayın platformunu seçmek için "Platform" menüsünü tıklayın. Seçenekler arasında YouTube, Facebook ve Twitch bulunur. Cihaza aktardığınız özel internet yayın ayarlarınız varsa onlar da platform listesinde belirir.

Özel bir URL adresine internet yayını yapmak için "platform" menüsünden bir özel URL seçimi yapın. Web Presenter 4K'da, özel bir URL'ye internet yayını H.264 veya H.265 kullanarak yapmayı seçebilirsiniz; Web Presenter HD'de, H.264 kullanarak özel bir URL'ye internet yayını yapabilirsiniz.

Sunucu

Listeden konunuza en yakın sunucuyu seçin. Seçmiş olduğunuz internet yayın platformuna bağlı olarak sunucu listesi değişir.

Instagram, Microsoft Teams veya özel bir URL adresine internet yayını yaptığınızda, sunucu listesi düzenlenebilir bir alan haline gelir. İnternet yayın platformu hesabınızdan atanan URL adresini veya özel URL detaylarını girin.

Yayın Şifresi

İnternet yayın platformundan yayınınız için atanan yayın şifresini girin.

Parola

SRT internet yayın protokolü ile bir internet yayın hizmeti kullanıyorsanız, internet yayın platformu hesabınızdan atanan parolayı girin.

Kalite

Kullandığınız Web Presenter modeline göre, HD veya 4K için internet yayın kalitesini seçin.

H.264	
HD	4K
HyperDeck Yüksek 45 ila 70 Mb/sn	HyperDeck Yüksek 95 ila 220 Mb/sn
HyperDeck Orta 25 ila 45 Mb/sn	HyperDeck Orta 66 ila 150 Mb/sn
HyperDeck Düşük 12 ila 20 Mb/sn	HyperDeck Düşük 38 ila 80 Mb/sn
İnternet Yayını Yüksek Hız 6 ila 9 Mb/sn	İnternet Yayını Yüksek Hız 34 ila 51 Mb/sn
İnternet Yayını Orta Hız 4.5 ila 7 Mb/sn	İnternet Yayını Orta Hız 23 ila 35 Mb/sn
İnternet Yayını Düşük Hız 3 ila 4.5 Mb/s Mb/sn	İnternet Yayını Düşük Hız 13 ila 20 Mb/sn

H.265	
HD	4K
İnternet Yayını Yüksek Hız 2.3 ila 4.5 Mb/sn	İnternet Yayını Yüksek Hız 22.5 ila 30 Mb/sn
İnternet Yayını Orta Hız 1.5 ila 3 Mb/sn	İnternet Yayını Orta Hız 14 ila 20 Mb/sn
İnternet Yayını Düşük Hız 0.8 ila 2 Mb/sn	İnternet Yayını Düşük Hız 8 ila 10 Mb/sn

Kalite ayarı tarafından kullanılan veri hızı, Web Presenter'inizin kullandığı video standardına bağlı olarak değişir. Örneğin, yüksek kaliteli internet yayınına seçerseniz ve 1080p24'te çalışıyorsanız, bu durumda 6 Mb/sn'lik veri hızını kullanır.

Çizelgede görebildiğiniz gibi, internet yayını için veri hızları, HyperDeck hızlarına kıyasla daha düşüktür. Bu, bir diske veri kaydetmeye kıyasla, genel olarak daha düşük bir bant genişliği kullanan internet üzerinden veri aktarımına imkân verir.

Bahsedilen her bir ayarın 2 adet veri hızı olduğunu fark edeceksiniz. 50p ve 60p'lik daha yüksek kare hızlarında çalıştığınızda, daha yüksek veri hızları kullanılırken, daha düşük veri hızları; 24p, 25p ve 30p'lik daha düşük kare hızları için kullanılır. İnternet yayın kalitesi için varsayılan ayarın Streaming High 6 ila 9 Mb/sn olduğunu belirtmemizde fayda var. Bu ayar, çok yüksek kalitede bir internet yayın kanalı sağlar.

Off ve On Air butonları

'Off' ve 'On Air' butonlarını kullanarak bir canlı internet yayını başlatabilir veya durdurabilirsiniz. Bir canlı internet yayını esnasında, 'on air' butonu kırmızı yanar.

Yüklenmiş Ayarların Kaldırılması

Cihaza yüklenen tüm internet yayın ayarlarını Web Presenter'inizden kaldırmak için, "canlı internet yayını" sekmesinin sol altındaki dişli simgesini tıklayın. Seçiminizi onaylamak için "kaldır" butonunu tıklayın.

Ses Sekmesi

Ses sekmesinde, Web Presenter'inizin ses monitör çıkışı ve ses göstergelerini yapılandırmak için seçenekler bulunur.

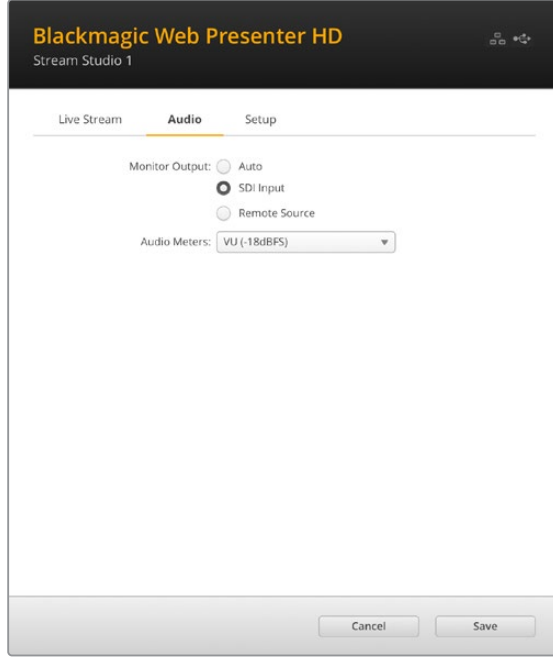

Monitör Çıkışı

Web Presenter'inizin SDI ve HDMI görüntüleme çıkışlarında kullanılan ses kaynağını seçmek için monitör çıkışı seçeneklerini kullanın.

Otomatik

Monitör çıkışı 'otomatik' olarak ayarlandığında, bir ATEM Streaming Bridge aracılığıyla bir ATEM görüntü mikserinden gönderilen talkback sesini Web Presenter'iniz otomatik olarak algılar ve monitörlere gönderir. Herhangi bir talkback sinyali algılanmazsa, SDI girişinden gelen ses kullanılır.

SDI Girişi

Web Presenter'inize bağlı bir Blackmagic Studio Camera gibi, SDI giriş kaynağından gelen sesi dinlemek için "SDI girişi"ni seçin.

Uzak Kaynak

Uzak bir ATEM görüntü mikserinden veya bir ATEM Streaming Bridge'den gönderilen talkback sesini dinlemek için bu seçeneği kullanın.

Ses Göstergeleri

Ses göstergeleri menüsünü kullanarak görüntülenmesini istediğiniz ses göstergesi türünü seçin. Seçenekler arasında; VU -18dBFS, VU -20dBFS, PPM -18dBFS veya PPM -20dBFS referans seviyeleri bulunur.

Ayarlar Sekmesi

Blackmagic Web Presenter HD
Stream Studio 1

Live Stream Audio **Setup**

Name: Stream Studio 1
Language: English
Software: Version 3.3

Network

Protocol: DHCP Static IP
IP Address: 192.168.24.100
Subnet Mask: 255.255.255.0
Gateway: 192.168.24.1
Primary DNS: 8.8.8.8
Secondary DNS: 8.8.4.4
Connection Priority: Ethernet Mobile

Reset
Factory Reset

Cancel Save

Name (İsim)

Web Presenter cihazınıza yeni bir isim vermek isterseniz, kutuya yeni ismi girin ve 'save' (kaydet) butonunu tıklayın.

Language (Dil)

Cihazın dil ayarını değiştirmenizi mümkün kılar.

Software (Yazılım)

Web Presenter'deki mevcut yazılımın sürüm bilgilerini görüntüler.

Ağ

Bu ayarlar, DHCP üzerinden bir ağa bağlanmak veya sabit bir IP adresi kullanmak arasında bir seçim yapmak gibi seçenekleri yapılandırmanıza olanak verir. Web Presenter'inizi bir ağa bağlama konusunda daha fazla bilgi için kılavuzun 'ağ ayarları' bölümüne bakın.

Bağlantı Önceliği - Web Presenter'e hem Ethernet hem de bir cep telefonu bağlıyken, internet yayını için hangi bağlantının kullanılacağını bu ayar seçer. Cep telefonunun internet bağlantısını paylaşmak hakkında daha fazla bilgi için 'cep telefonunuzu kullanarak internet yayını yapma' başlıklı bölüme bakın.

Ayarları Sıfırlama

Fabrika ayarlarına sıfırla butonunu tıklayarak Web Presenter'i sıfırlayabilirsiniz.

Ağ Ayarları

Web Presenter'iniz, statik bir IP adresi veya DHCP kullanarak ağa bağlanabilir.

DHCP - Cihazınız için otomatikman bir IP adresi ayarlar ve hiç bir ayarı değiştirmeden ağınıza bağlar.

Dinamik ana bilgisayar yapılandırma protokolü veya diğer adıyla DHCP, ağ sunucularında ve yönlendiricilerde Web Presenter'inizi otomatikman tespit ederek IP adresi atayan bir hizmettir. DHCP, Ethernet üzerinden ekipmanların bağlanmasını ve IP adreslerinin birbirleriyle çakışmasını önlemeyi kolaylaştırır. Bilgisayarların ve ağ anahtarlarının çoğu DHCP'yi destekler.

Statik IP - IP adresini kendiniz ayarlamak isterseniz, protokol ayarını 'statik IP' olarak ayarlamaz ve IP ayarlarını manuel olarak değiştirmeniz yeterlidir.

Sabit bir IP adresi, Web Presenter cihazınız yeniden başlatıldığında bile değişmeyen bir adrestir.

Web Presenter cihazınızı kurumsal bir ağa bağlıyorsanız, sabit bir IP adresinin kullanılması gerekebilir. Bir ağ yöneticiniz varsa muhtemelen ağınız, kendisine bağlı olan tüm ekipmanlar için özel IP adreslerine sahiptir. Şirketinizdeki bilgisayarları ve ağ yönetip yönetmediklerini ağ yöneticinizle görüşmeniz önerilir.

İnternet Paylaşımının Doğrudan İnternet Yayını için Ayarlanması

Web Presenter'i doğrudan bir ağ anahtarına veya internet yönlendiriciye takmanız mümkün değilse Ethernet portu aracılığıyla bilgisayarınızın internet bağlantısını Web Presenter ile paylaşabilirsiniz.

Blackmagic Web Presenter'i doğrudan internet yayını için ayarlamak üzere:

- 1 Web Presenter'inizi DHCP kullanması için ayarlayın.
- 2 Ethernet portu aracılığıyla internet bağlantısını paylaşması için bilgisayarınızı yapılandırın.

Mac: Sistem Tercihlerine girin, 'paylaşım'ı tıklayın ve ardından servis listesinde 'internet paylaşım'ı seçin. Mac'iniz wifi üzerinden internete bağlıysa 'şuradaki bağlantıyı paylaş' menüsünde 'wi-fi' ibaresini seçin. 'Şunu kullanarak paylaş' listesinde, 'ethernet' seçin. 'Servis' listesinde 'internet paylaşım' onay kutusunu işaretleyin. İnternet paylaşımını açmak istediğinizden emin misiniz diye sorulduğunda, 'başlat'ı tıklayın.

Windows: 'Başlat' ikonunu sağ tıklayın ve 'ağ bağlantıları' ibaresini seçin. 'Ağ durumu' ekranı belirecektir. 'Adaptör ayarlarını değiştir' ibaresini tıklayın. Bu, bilgisayarınızın ağ bağlantılarını sıralar. İnternet bağlantısı üzerine sağ tıklayın ve 'özellikler'i seçin. 'Paylaşım' sekmesinde, 'internet bağlantımı diğer cihazlarla paylaş' seçeneğini işaretleyin. Menüde bir ağ bağlantısı seçin ve sonra 'OK' butonunu tıklayın.

- 3 Web Presenter'i bilgisayarınızın Ethernet portuna takın. DHCP, birkaç saniye sonra Web Presenter'e bir IP adresi atayacaktır.
- 4 Cihazın LCD ekranının sağ üst köşesindeki Ethernet ikonunu izleyerek, Web Presenter'inizin internete Ethernet üzerinden bağlı olduğunu teyit edin.

Akıllı Telefonunuzu Kullanarak İnternet Yayını

Blackmagic Web Presenter akıllı telefonunuzun internet bağlantısını paylaşarak internet yayını yapabilir. Akıllı telefonunuzun hücresel veri bağlantısının olduğu herhangi bir konumdan, dünyaya internet üzerinden yayın yapabilirsiniz.

Akıllı telefonunuzun internet paylaşımını kullanmayı ayarlamak için:

- 1 Bir USB-C kablosu yardımıyla, akıllı telefonunuzu Blackmagic Web Presenter'e bağlayın. Ön veya arka paneldeki USB-C portunu kullanabilirsiniz.
- 2 Akıllı telefonunuzun kişisel erişim noktasını etkinleştirin.

iOS cihazınızda ayarlar > kişisel erişim noktası'na gidin ve 'diğerleri katılabilisin' seçeneğinin açık olduğundan emin olun. Android cihazınızda, hızlı menüyü görüntülemek üzere ekranı kaydırın. Kişisel erişim noktası ikonunu basılı tutun ve ardından USB internet paylaşımı etkinleştirin.

Şimdi, canlı internet yayınına geçmek için Blackmagic Web Presenter üzerindeki 'on air' butonuna basabilirsiniz.

BİLGİ İnternet yayını sonlandıktan sonra, akıllı telefonunuzun bataryasının bitmemesi için internet paylaşma bağlantılarını kapatmanızı öneririz.

Web Presenter'inize bir Ethernet kablosu bağlıysa akıllı telefon üzerinden internet paylaşımı için yapılandırılmış olduğunu teyit etmeniz gerekir. Web Presenter Setup yardımcı yazılımını açın ve 'ayarlar' sekmesine gidin. 'Ağ' bölümünde, bağlantı önceliğini 'mobile' (cep telefonu) olarak ayarlayın.

Blackmagic Web Presenter'in bir Web Kamerası Olarak Kullanımı

Skype veya Zoom gibi yazılımlar, Web Presenter'i otomatikman web kamerası olarak ayarlar, dolayısıyla uygulamayı başlattığınızda Web Presenter'inizden gelen videoyu anında görürsünüz. Uygulama, Web Presenter'i otomatik olarak seçmezse web kamerası ve mikrofon olarak kullanılması için Web Presenter'i manuel olarak ayarlayın.

Aşağıda, Skype uygulamasında bilgisayar kamera ayarlarını nasıl düzenleyeceğinizin bir örneğini bulabilirsiniz.

- 1 Skype'nin menü çubuğunda, 'video ve ses ayarları' seçeneğini açın.
- 2 'Kamera' menüsünü tıklayın ve listeden Web Presenter'inizi seçin. Web Presenter'den alınan videoyu, önizleme penceresinde göreceksiniz.
- 3 'Mikrofon' menüsüne gidin ve Web Presenter'inizi ses kaynağı olarak seçin.

Open Broadcaster Uygulamasının Kurulumu

Open Broadcaster yazılımı; YouTube, Twitch, Facebook Live ve başka internet yayın yazılımları ile Web Presenter'iniz arasında bir internet yayın platformu işlevi gören, açık kaynaklı bir uygulamadır. Open Broadcaster, internet yayın uygulamanız tarafından kolaylıkla yönetilebilen bir bit oranına videonuzu sıkıştırır.

İnternet yayın hizmeti olarak YouTube Live'yi kullanarak, Web Presenter'inizden alınan web kamera çıkışını internet üzerinden yayınlamak üzere Open Broadcaster uygulamasını nasıl düzenleyeceğinizi, aşağıda gösterilmiştir.

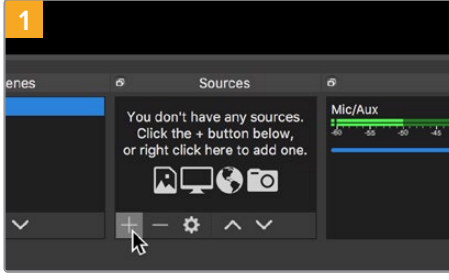

Open Broadcaster uygulamasını başlatın ve 'sources' (kaynaklar) kutusundaki artı (+) sembolü üstüne tıklayın.

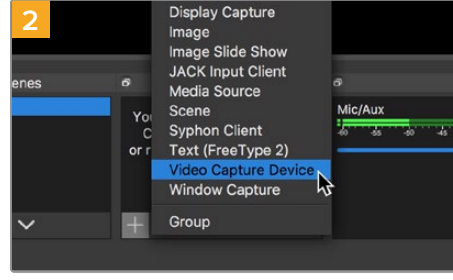

'Video Capture Device' (video yakalama cihazı) ibaresini seçin.

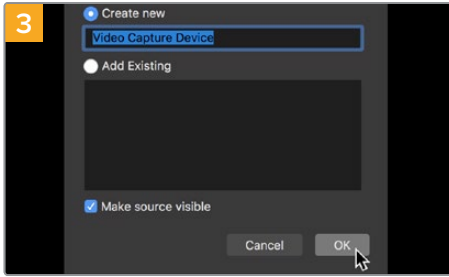

Yeni kaynağa bir isim verin ve 'OK' ibaresini tıklayın.

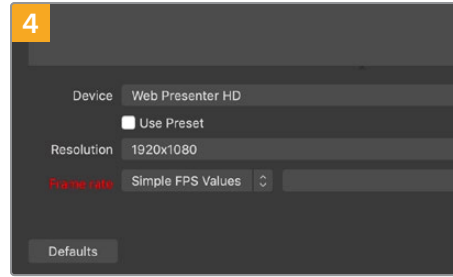

Cihaz menüsünde, Web Presenter modelini seçin ve 'OK' butonunu tıklayın.

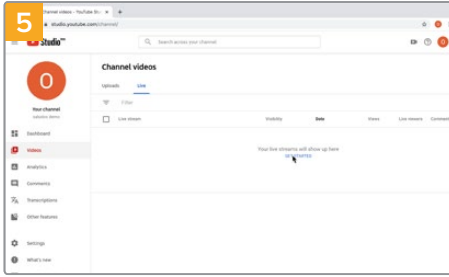

Şimdi YouTube hesabınıza gidin. 'Canlı yayın başlat' butonunu tıklayın, sonra 'stream' (internet yayını) üzerine tıklayın.

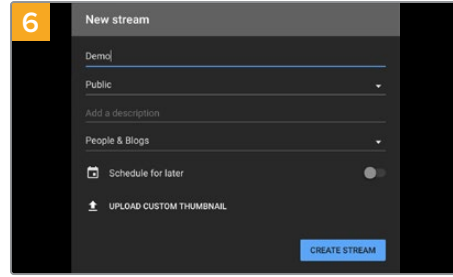

Youtube'deki 'internet yayını' seçeneklerinde, yayın detaylarınızı girin ve 'internet yayını oluştur' ibaresini tıklayın.

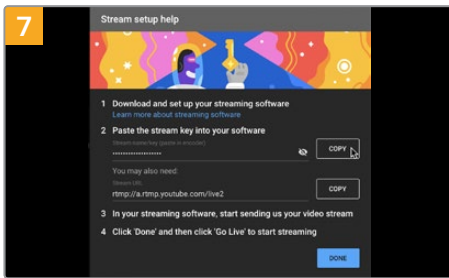

YouTube şimdi; Open Broadcaster uygulamasını YouTube hesabınıza yönlendirecek bir internet yayın şifresi üretecektir. Yayın şifresinin yanındaki 'kopyala' butonunu tıklayın. Open Broadcaster uygulamasına yapıştıracağınız internet yayını şifresini kopyalayın.

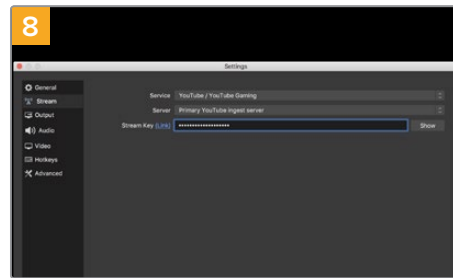

Open Broadcaster uygulamasına geri dönün ve menü çubuğundaki 'OBS/preferences' (OBS/tercihler) seçeneğini tıklayarak tercihleri açın. 'Stream' (internette yayımla) ibaresini seçin. Şimdi, YouTube'den kopyaladığınız yayını şifresini yapıştırın ve 'OK' ibaresini tıklayın.

Şimdi, Web Presenter'inizden alınan videonun, Open Broadcaster uygulamasının önizleme penceresinde yayınlandığını göreceksiniz.

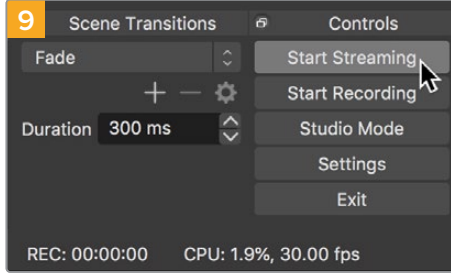

Open Broadcaster'in yayın bağlantısını YouTube ile bağlamak üzere, ekranın sağ alt köşesindeki 'start streaming' (internet yayını başlat) ibaresini tıklayın. Bu işlem, Open Broadcaster uygulamasından YouTube'ye bağlantıyı kurar ve artık buradan YouTube Live kullanarak her şey hazırlanabilir.

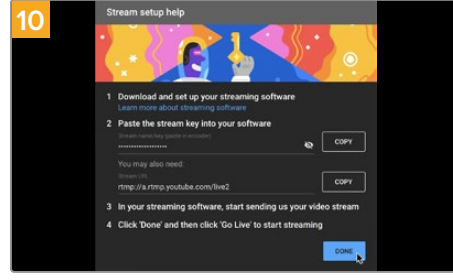

YouTube Live'ye geri dönün ve Web Presenter'inizden alınan web kamera program çıkışını, arka planda göreceksiniz. 'Tamam' butonunu tıklayın.

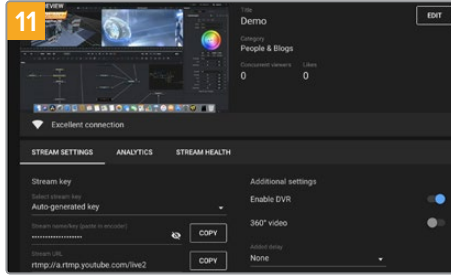

Open Broadcaster uygulamasının YouTube Live ile iletişimde olmasıyla, artık yayınıza başlamaya hazırsınız. Şimdi, son kontrollerinizi yaparak her şeyin iyi olduğundan emin olabilirsiniz.

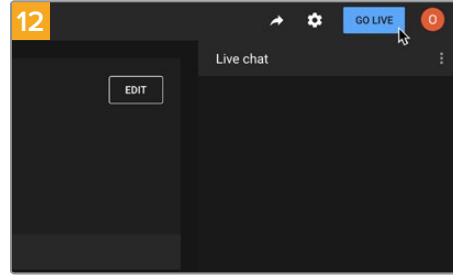

Hazırsanız, 'canlı yayın başlat' ibaresini tıklayarak yayınıza başlayabilirsiniz.

Şimdi, Open Broadcaster ile YouTube'de canlı internet yayını yapıyorsunuz.

NOT İnternet yayınının doğası nedeniyle, genellikle bir gecikme yaşanması muhtemeldir. Bu yüzden, internet yayını YouTube'de izlemek ve 'yayını bitir' butonuna basarak yayını bitirmeden önce, kazayla yayınının sonunu erken bitirmediğinizden emin olmak için, programınızın bittiğini teyit etmek önemlidir.

ATEM Streaming Bridge ile Video Bağlantılarının Oluşturulması

ATEM Streaming Bridge, herhangi bir Web Presenter'den alınan internet yayın videosunun kodunu çözmenizi ve tekrar SDI ya da HDMI videoya dönüştürmenizi sağlar. Yerel ağınıza veya internet aracılığıyla dünyanın herhangi bir yerine video göndermenize olanak tanır.

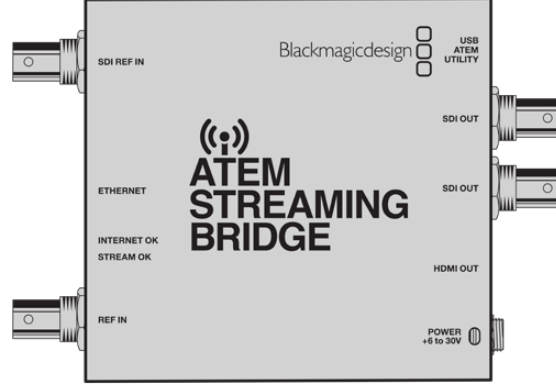

ATEM Streaming Bridge cihazınız, Web Presenter'inizle aynı yerel ağa bağlıysa Web Presenter Setup yazılımındaki canlı internet yayını sekmesinin 'platform' menüsündeki listede belirecektir.

Aksi takdirde, cihaza bağlı bir USB diskteki bir internet yayın ayarı XML dosyasını ya da Web Presenter Setup yardımcı yazılımıyla bilgisayarınız üzerinden Web Presenter'e yükleyebilirsiniz.

ATEM Streaming Bridge ile Blackmagic Web Presenter'in birlikte nasıl çalışabileceğinin iyi bir örneği, uzak bir konumdan bir stüdyoya hava durumu raporu iletmektir. Belirli bir konumdan sinyal göndermek için ihtiyacınız olan bir Web Presenter cihazı ve bir internet bağlantısıdır, bu akıllı telefonunuz üzerinden olabilir veya bir ağa bağlanabilirsiniz.

Stüdyoda, ATEM Streaming Bridge stüdyodaki ana switcher'e bağlanabilmesi için internet sinyalini alır ve SDI'ya dönüştürür.

Bu örnek için iş akışı kurulumu şu şekildedir:

- 1 Stüdyo dışında, Blackmagic Web Presenter, switcher üzerindeki Program SDI çıkışına bağlanır. Örneğin, bir ATEM Constellation 8K gibi.
- 2 Bunun ardından Blackmagic Web Presenter bir akıllı telefona bağlanır.
- 3 Stüdyoda, ATEM Streaming Bridge ayrıca internete Ethernet üzerinden bağlanır.
- 4 Bunun ardından, ana haber yayını için ATEM Streaming Bridge, internetten alınan dönüştürülmüş SDI video sinyalini stüdyodaki switcher'in SDI girişine gönderir.

Stüdyonuzun ATEM Streaming Bridge'yi Web Presenter'in internet sinyaline bağlaması için, ATEM Setup yardımcı yazılımını başlatmanız ve internet ayarlarını yapılandırmanız gerekecektir. Bunlar arasında, tüm internet yayın ayarlarını içeren bir XML dosyasının oluşturulması ve daha sonra setteki Web Presenter'e yüklenmesi bulunur.

XML Dosyasının Oluşturulması

Bir XML ayarları dosyası oluşturmak için, “Ethernet” portundan bir ağ kablosunu bir internet yönlendiricisine veya ağ anahtarına bağlayarak, ATEM Streaming Bridge’yi internete bağlayın.

ATEM Streaming Bridge’yi bir USB-C kablosu kullanarak bilgisayarınıza bağlayın ve ATEM Setup uygulamasını başlatın.

Kurulum sekmesinde, ağ ayarlarının doğru olduğunu onaylayın ve “internet yayın hizmeti” seçeneklerinden ‘internet’i seçin. İnternet durum kutusunda “dünya çapında görünür” mesajını görmelisiniz. Bu, her şeyin doğru çalıştığı anlamına gelir.

Bağlantı Noktası Yönlendirme Hakkında

“İnternet durumu” kutusunda bir bağlantı noktası yönlendirme veya UPnP hatası görürseniz, internet sağlayıcınızdan veya ağ yöneticinizden, internet bağlantınızdaki bağlantı noktası yönlendirmeyi ‘TCP port 1935’e ayarlamasını istemeniz gerekecektir.

XML Dosyasını Dışa Aktarma

ATEM Setup sekmesinde ayarlarınızı onayladıktan ve ATEM Streaming Bridge’nizi ağınıza veya internete başarıyla bağladıktan sonra, XML kurulum dosyasını dışa aktarabilirsiniz.

- 1 Pencerenin sağ üst köşesindeki ‘harici ATEM Mini Pro’ sekmesini tıklayın.

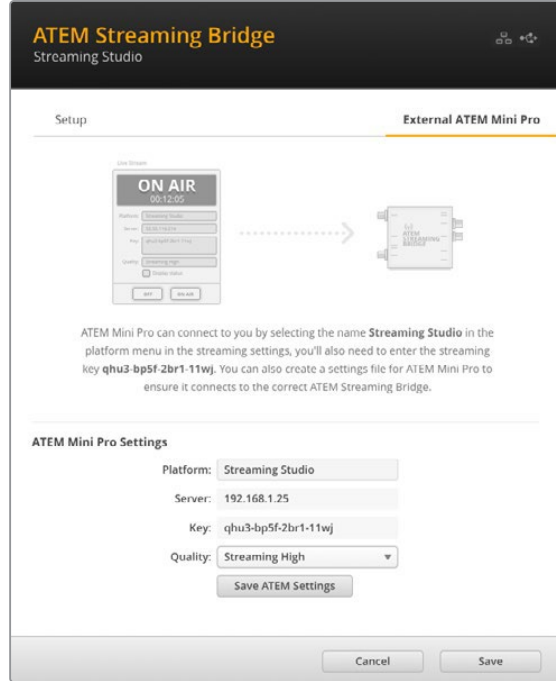

- 2 Platforma özel bir ad vermek için “platform” kutusunu tıklayın ve yeni bir ad yazın. Bu ad, uzaktaki Blackmagic cihazının platform menüsünde beliren adı olacaktır.
- 3 İnternet yayın kalitesini seçin. Bu ayar, uzaktaki Web Presenter’deki kalite ayarını düzenleyecektir.
- 4 “ATEM Ayarlarını Kaydet” butonunu tıklayın, bilgisayarınızda XML dosyasını kaydetmek için bir konum seçin ve ‘kaydet’i tıklayın.
- 5 Artık kaydedilen XML dosyasını uzaktaki operatöre e-posta ile gönderebilirsiniz.

BİLGİ Uzaktaki Web Presenter'e geri göndermek istediğiniz ses kanallarını seçmek için ATEM Setup'taki talkback ayarlarını kullanabilirsiniz.

XML Dosyasını Yükleme

Elektronik posta yoluyla ayarlar dosyasının sete gönderilmesiyle, set ekibi Blackmagic Web Presenter Setup yardımcı yazılımını kullanarak XML dosyasını Web Presenter'e yükler, sonra hava durumu raporunu stüdyoya internet üzerinden yayınlamak üzere 'on air' butonuna basar!

İnternet yayın XML dosyasını yükledikten sonra, tekrar yüklemenize gerek kalmadan yayını başlatıp durdurabileceğinizi belirtmekte fayda var. Bu, Web Presenter ve ATEM Streaming Bridge arasında sabit bir video bağlantısı kurmayı kolaylaştırır.

Stüdyodaki ATEM Streaming Bridge, internet yayın ve ağ ayarlarını değiştirmedeği ve halen o Web Presenter cihazını aradığı müddetçe, internette nerede olursa olsun mutlaka bulacaktır. Bulduğunuz her yerde, Web Presenter ünitenizi internete bağlayabilir, 'on air' butonuna basabilirsiniz ve anında ünite, stüdyodaki ATEM Streaming Bridge cihazına internet üzerinden yayın yapacaktır.

ATEM Streaming Bridge cihazını nasıl kullanacağınız hakkında daha fazla bilgiyi, www.blackmagicdesign.com/tr/support adresinden indirebileceğiniz ATEM Mini kullanım kılavuzunda bulabilirsiniz.

Tally, Talkback ve Kamera Kontrolü

ATEM Streaming Bridge ve Blackmagic Web Presenter ayrıca ATEM switcher'lerin tally, talkback ve kamera kontrol bilgilerini göndermesine olanak tanır. Bu, herhangi bir SDI tabanlı Blackmagic Design kamerasının, yerel ağınızın kapsamı dahilinde herhangi bir yere veya İnternet üzerinden dünyanın herhangi bir yerine konumlandırılabilceği ve hala tally, talkback ve kamera kontrol işlevlerine sahip olacağı anlamına gelir.

Kurulumu çok kolaydır. Aşağıdaki çizim; tally, talkback ve kamera kontrolü ile yerel bir ağ üzerinden bir URSA Mini Pro 4.6K'nın bir ATEM Constellation 8K'ya nasıl bağlanacağını göstermektedir.

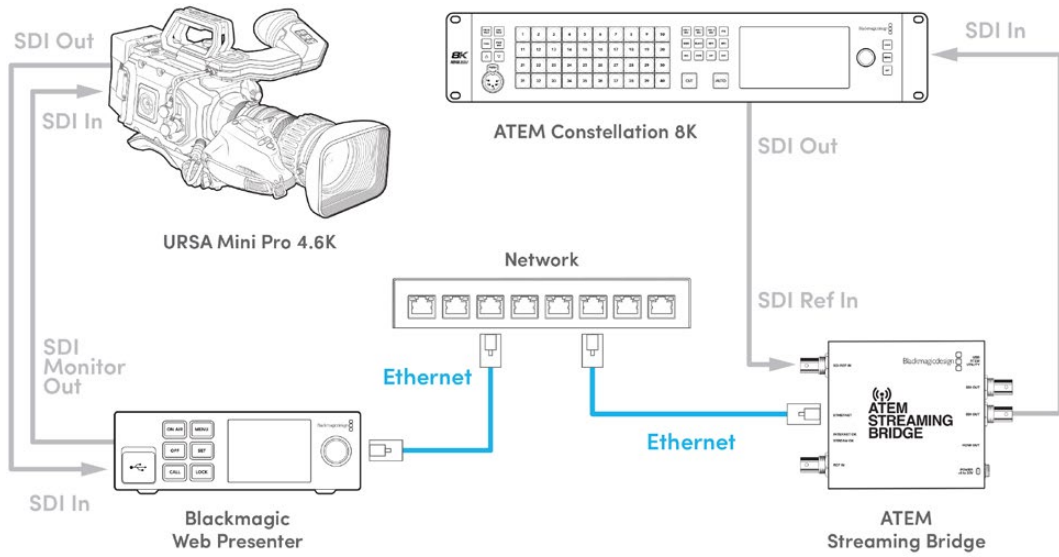

Her şey bağlandığında:

- 1 LCD menüsünü açmak için Blackmagic Web Presenter'deki "menü" butonuna basın ve "canlı internet yayını" menüsüne gidin.
- 2 'Platform' ayarında, ATEM Streaming Bridge cihazını seçin.
- 3 Teyit etmek için 'set' butonuna basın.

Tally'nin çalışması için kameranın, switcher üzerindeki girişle eşleşecek şekilde ayarlanmış ATEM kamera kimliğine sahip olduğundan emin olmanız gerekir. ATEM kamera kimliğinin nasıl ayarlanacağı hakkında bilgi için URSA Mini kılavuzuna bakın.

Kamerayı ATEM switcher üzerindeki program çıkışına yönlendirerek, tally'nin çalışıp çalışmadığını test edebilirsiniz. ATEM kamera kimliği kameranızda doğru bir şekilde ayarlanmışsa kamera LCD'sinin çevresinde kırmızı bir tally kenarlığı dahil olmak üzere, tally lambasının yandığını göreceksiniz. Şimdi kamerayı ön izleme çıkışına yönlendirin ve tally yeşil yanacaktır.

Kamera kontrolünü test etmek için ATEM Software Control'un kamera sayfasında diyafram ve ana siyahı ayarlamayı deneyin.

Gömülü SDI ses kanalları 15 ve 16, varsayılan talkback kanalları olarak ayarlanmıştır ancak bunları, ATEM Setup yardımcı yazılımını kullanarak teknik ekip kanalları 13 ve 14 veya program çıkışı olarak değiştirebilirsiniz.

İnternet üzerinden aktarım yaparken, ATEM Setup yardımcı yazılımı kullanılarak bir XML kurulum dosyası oluşturulur. Bu XML dosyası daha sonra, İnternette ATEM Streaming Bridge'yi bulabilmesi için Blackmagic Web Presenter'e yüklenir. Kurulum XML dosyasının nasıl oluşturulacağı ve yükleneceği hakkında daha fazla bilgi için bu kılavuzda bir önceki bölüme bakın.

URSA Broadcast G2'nin Bağlanması

URSA Broadcast G2, yerleşik bir internet yayını motoruna sahiptir; yani kamera doğrudan USB-C genişletme portundan internet yayını gerçekleştirilebildiğinden, bir Blackmagic Web Presenter kullanmanıza gerek yoktur. Tally'nin doğru çalışması için ATEM kamera kimliğinin nasıl ayarlanacağı da dahil olmak üzere daha fazla bilgi için URSA Broadcast G2 kılavuzuna bakın.

Blackmagic Universal Rack Shelf

Blackmagic Universal Rack Shelf; geniş bir Blackmagic Design ekipman yelpazesini bir yayın rafına veya taşıma kasasına monte etmenizi sağlayan, 1 RU boyutunda bir ekipman rafıdır. Bu modüler tasarım, tek raf ölçüsünde ürünler kullanarak taşınabilir ve pratik ekipman kurulumları oluşturabilmenizi sağlar.

Aşağıdaki şema, uyumlu cihazlardan oluşan bir kombinasyon takılarak küçük bir rafa monte edilmiş 3 adet Universal Rack Shelf göstermektedir. En alttaki rafta, cihazlar arasındaki kullanılmayan boşluğu kapatmak için 1/3 raf genişliğinde bir kapatma paneli bulunmaktadır.

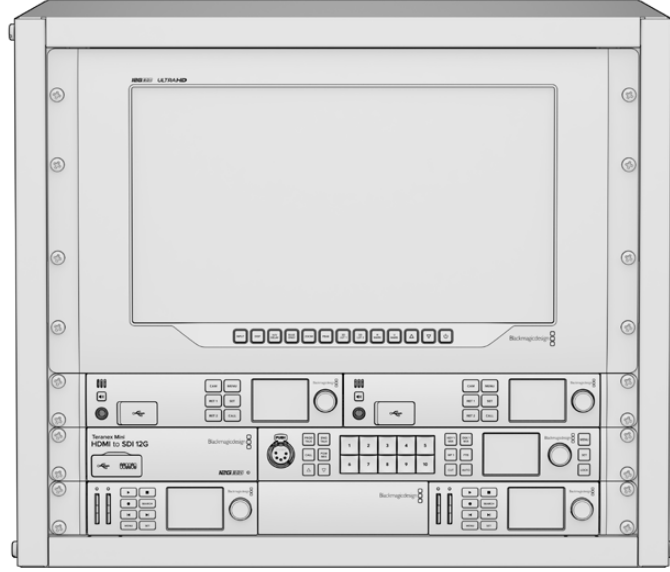

Ürün İçeriği

Universal Rack Shelf Kit şu parçaları içerir:

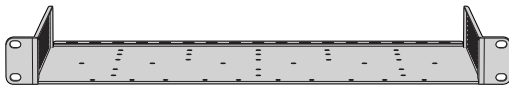

1 adet Blackmagic Universal Rack Shelf

1 adet tam genişlikte raf birimi, Blackmagic Design ekipmanlarını monte etmek için.

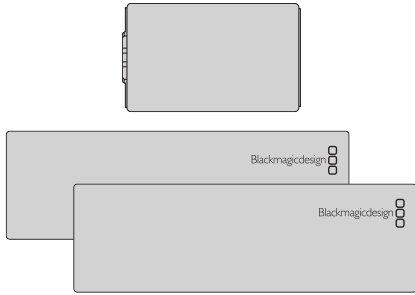

Boşluk Kapatma Panelleri

1 adet 1/6 ve 2 adet 1/3 raf genişliğinde kapatma paneli, kullanılmayan raf alanlarını kapatmak için.

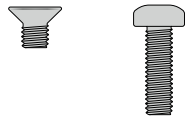

Vidalar

12 adet M3 5mm gömme başlı montaj vidası. 2 adet M3 9mm düz vida, 1/6 kapatma panelleri için.

Bir Cihazın Ekipman Rafına Monte Edilmesi

- 4 Lastik ayaklar takılıysa plastik kenarlı bir sıyırma aleti kullanarak ayakları cihazın tabanından çıkarın.
- 5 Hem ekipman rafı hem de cihaz baş aşağı olacak şekilde, ekipman rafında açılmış delikleri Blackmagic Design cihazdaki vida yuvalı montaj delikleriyle hizalayın. 1/3 genişliğindeki cihazların ortasında iki adet montaj noktası ve daha büyük, 1/2 raf genişliğindeki cihazlarda ise üçe kadar montaj noktası bulunur.

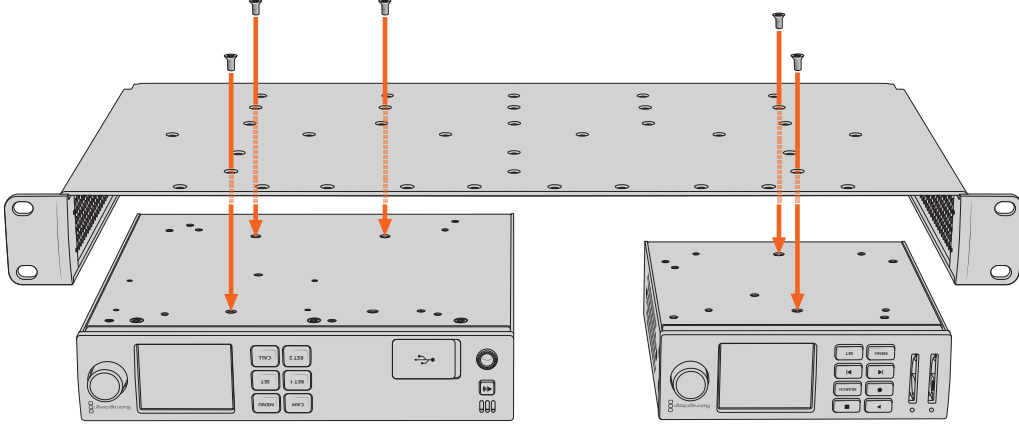

- 6 Verilen M3 5mm gömme başlı vidaları kullanarak cihazı ekipman rafına sabitleyin.
- 7 Sabitledikten sonra, ekipman rafını üst tarafı yukarı bakacak şekilde çevirin ve yerleşik raf kulaklarını kullanarak rafa monte edin.

Kullanılmayan raf alanlarını kapatmak için verilen kapatma panellerini kullanabilirsiniz.

1/6 Genişliğindeki Kapatma Panelinin Takılması

1/2 ve 1/3 raf genişliğindeki cihazları takarken, kullanılmayan raf alanını kapatmak için küçük 1/6 kapatma paneli kullanılabilir. Panel, her iki cihazın yan tarafına takılabilir. Hava akışını iyileştirmek için paneli cihazların arasına takmakta fayda var.

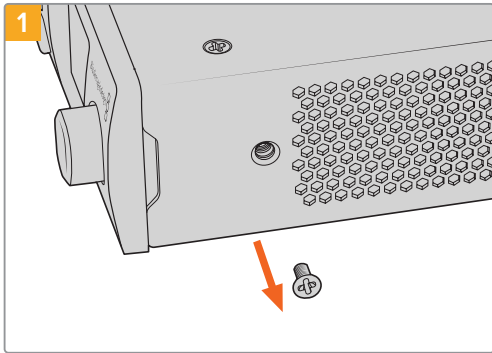

Cihazın ön tarafına yakın olan 5mm M3 vidayı çıkarın.

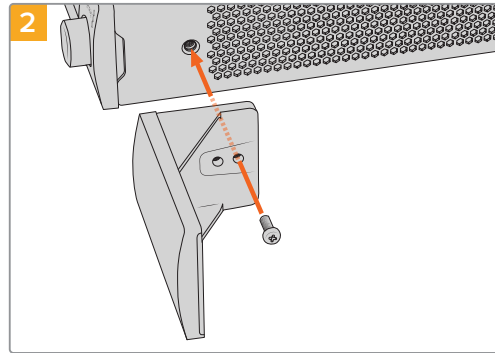

Kapatma panelini hizalayın ve verilen M3 9mm naylon vidayı kullanarak takın

1/3 Genişliğindeki Yan Kapatma Panelinin Takılması

Tekli cihazlar takarken, 1/3 genişlikteki büyük kapatma panelleri, ekipman rafının iki yanına da doğrudan takılabilir. Bir kapatma panelini takmak için, panelin altındaki vida deliklerini ve kılavuz noktasını rafla hizalayın ve verilen M3 5mm gömme başlı vidaların ikisini kullanarak yerine tutturun.

Dahili Yazılımın Güncellenmesi

Kurulum yardımcı yazılımı; internet yayın ayarlarını, ağ ayarlarını ve internet yayın kalitesini yapılandırmanın yanı sıra, Web Presenter'inizin dahili yazılımını da güncelleme için sağlar.

Dahili yazılımı güncellemek için:

- 1 www.blackmagicdesign.com/tr/support adresinden en yeni Blackmagic Web Presenter yükleyici sürümünü indirin.
- 2 Blackmagic Web Presenter yükleyiciyi çalıştırın ve ekrandaki talimatları takip edin.
- 3 Kurulum tamamlandıktan sonra, arka veya ön panel üzerindeki plastik toz kapağının altında bulunan USB konnektör aracılığıyla, Web Presenter'inizi bilgisayara bağlayın.
- 4 Blackmagic Web Presenter Setup yazılımını başlatın ve dahili yazılımı güncellemek için ekrandaki komutları takip edin. Herhangi bir komut belirmezse, bu dahili yazılımın güncel olduğunu işaret eder ve yapmanız gereken başka bir şey yoktur.

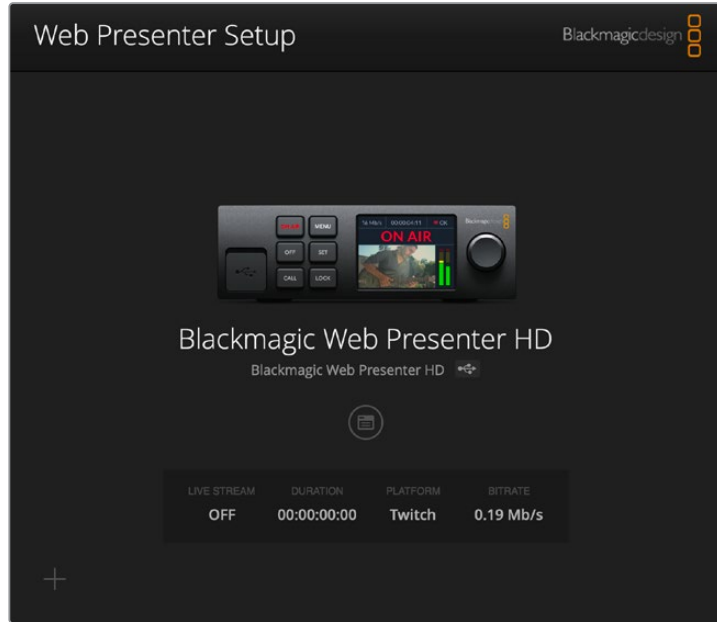

Blackmagic Web Presenter'iniz için en son kurulum yardımcı yazılımını www.blackmagicdesign.com/tr/support sayfasındaki Blackmagic Design destek merkezinden indirin.

Developer Information

Blackmagic Web Presenter Ethernet Protocol

v1.2

Protocol Details

Overview

The Blackmagic Web Presenter Ethernet Protocol is a line-oriented, text-based protocol to control a Web Presenter.

Lines from the Web Presenter server will be separated by an ASCII LF sequence.

Messages from the user may be separated by LF or CR LF.

Connection

The Web Presenter server is accessed by connecting to TCP port 9977 on a Web Presenter.

Connection Response

Upon connection, the Web Presenter server sends a dump of the device's state.

The Web Presenter server sends information in blocks, with each having an identifying header followed by a colon. A block spans multiple lines and is terminated by a blank line. Each line in the protocol is terminated by a newline character.

Following the header, a block contains either a single multi-line string or a sequence of key/value pairs arranged one per line. The first full-colon on a line is used to delimit the key and the value. A value may be a comma separated list. In this case, values in the list must have the “,” and “\” characters escaped with a “\” character.

To be resilient to future protocol changes, clients should ignore blocks they do not recognize, up to the trailing blank line. Within recognized blocks, clients should ignore keys they do not recognize.

Legend	
↵	End of line
...	and so on
Orange Text	Client Generated
Grey Text	Server Generated

The protocol preamble block is always the first block sent by the Web Presenter server:

```
PROTOCOL PREAMBLE:↵
Version: 1.2↵
↵
```

The version field indicates the protocol version. When the protocol is changed in a compatible way, the minor version number will be updated. If incompatible changes are made, the major version number will be updated.

The initial status dump is concluded by the end prelude block:

```
END PRELUDE:↵
↵
```

Status Updates

When any device parameter is changed on the Web Presenter server by any client, such as the Blackmagic Web Presenter Setup utility, the Web Presenter server resends the applicable status block, containing only the items that have changed. Status updates can also occur due to external changes such as tethering to a smartphone or when a streaming service is disconnected.

For example, if the input video mode is set to Auto, the following block will be sent:

```
STREAM SETTINGS:↵  
Video Mode: Auto↵  
↵
```

Requesting Changes

To change one or more parameters in a block, the client should send the appropriate block header in the same form the Web Presenter server sends, followed by the key/value pairs to be changed. For example, to change the input video format to 1080p59.94, the user should send the following block:

```
STREAM SETTINGS:↵  
Video Mode: 1080p59.94↵  
↵
```

The block must be terminated by a blank line. On receipt of a blank line, the Web Presenter server will either acknowledge the request by responding:

```
ACK↵  
↵
```

or if unable to parse the block responding with:

```
NACK↵  
↵
```

After a positive response, the client should expect to see a status update from the Web Presenter server showing the status change. This is likely to be the same as the command that was sent, sometimes followed by other blocks providing data specific to the change.

```
STREAM SETTINGS:↵  
Video Mode: 1080p59.94↵  
↵
```

If the Web Presenter server does not understand a key in the requested block, the key will be ignored. If an invalid value is provided for a known key, then the request is ignored and the Web Presenter will respond with the existing value for the key. In both cases the Web Presenter server will still respond with an ACK.

```
STREAM SETTINGS:↵  
Video Mode: UnsupportedMode↵  
↵  
ACK↵  
↵  
STREAM SETTINGS:↵  
Video Mode: 1080p59.94↵  
↵
```

Requesting a Status Dump

The user may request that the Web Presenter server resend the complete state of any status block by sending the block header, followed by a blank line. In the following example, the user requests the Web Presenter server resend the stream settings:

```
STREAM SETTINGS:↵
↵
ACK↵
↵
STREAM SETTINGS:↵
Video Mode: 1080p59.94↵
...
↵
```

Protocol Blocks

Identity Block

The identity block contains information to identify the connected Web Presenter.

Block Syntax

The following example shows the Identity Block for a Blackmagic Web Presenter HD.

```
IDENTITY:↵
Model: Blackmagic Web Presenter HD↵
Label: Blackmagic Web Presenter HD↵
Unique ID: 00112233445566778899AABBCCDDEEFF↵
↵
```

Parameters

Key	Read/Write	Description	Valid Values
Model	Read only	The Web Presenter model name	String
Label	Read/Write	A display name for the Web Presenter	String
Unique ID	Read only	A device specific unique identifier	Hexadecimal ID

Changing Device Label

A device label to identify the Web Presenter can be changed by sending an identity block with label key.

```
IDENTITY:↵
Label: My Web Presenter↵
↵
ACK↵
↵
IDENTITY:↵
Label: My Web Presenter↵
↵
```

Version Block

The version block contains hardware and software version information for the connected Web Presenter.

Block Syntax

```
VERSION:↵  
Product ID: BE73↵  
Hardware Version: 0100↵  
Software Version: 0123ABCD↵  
Software Release: 3.3↵  
↵
```

Parameters

Key	Read/Write	Description	Valid Values
Product ID	Read only	The Web Presenter product ID	Hexadecimal ID
Hardware Version	Read only	The Web Presenter hardware version	Hexadecimal version
Software Version	Read only	The Web Presenter software version	Hexadecimal version
Software Release	Read only	The Web Presenter software release version	Version Number

Network Blocks

The network block contains the TCP/IP networking configuration for the connected Web Presenter.

Block Syntax

This example shows the output for a connected Web Presenter. It displays 2 networking interfaces - the Gigabit Ethernet interface and option for a tethered smartphone.

The network settings prefixed with Current show the active TCP/IP settings, and are read-only. The Current settings reflect either the DHCP or Static configuration, depending on the Dynamic IP flag.

```
NETWORK:↵  
Interface Count: 2↵  
Default Interface: 0↵  
↵  
NETWORK INTERFACE 0:↵  
Name: Ethernet↵  
Priority: 1↵  
MAC Address: 00:11:22:33:44:55↵  
Dynamic IP: true↵  
Current Addresses: 192.168.1.10/255.255.255.0↵  
Current Gateway: 192.168.1.1↵  
Current DNS Servers: 192.168.1.1, 8.8.8.8, 8.8.4.4↵  
Static Addresses: 10.0.0.2/255.255.255.0↵  
Static Gateway: 10.0.0.1↵  
Static DNS Servers: 8.8.8.8, 8.8.4.4↵  
↵
```

```

NETWORK INTERFACE 1:↵
Name: USBEthernet↵
Priority: 0↵
MAC Address: 00:00:00:00:00:00↵
Dynamic IP: true↵
Current Addresses: 0.0.0.0/255.255.0.0↵
Current Gateway: 0.0.0.0↵
Current DNS Servers: ↵
Static Addresses: 10.0.0.2/255.255.255.0↵
Static Gateway: 10.0.0.1↵
Static DNS Servers: 8.8.8.8, 8.8.4.4↵
↵

```

Parameters

Network Block

Key	Read/Write	Description	Valid Values
Interface Count	Read only	The number of networking interfaces supported by the Web Presenter	Integer
Default Interface	Read only	The default networking interface	Integer

Network Interface Block

Key	Read/Write	Description	Valid Values
Name	Read only	The name of the networking interface	String
Priority	Read/Write	The priority of the network interface. When multiple network interfaces are available, the high priority interface will become the default	Unsigned integer. The higher number is the higher priority
MAC Address	Read Only	MAC address of the networking interface	IEEE 802 MAC address
Dynamic IP	Read/Write	Selects DHCP or Static IP configuration	true - DHCP enabled false - Static IP
Current Addresses	Read Only	The current IP address and Subnet mask	{IPv4 address}/{Subnet Mask}
Current Gateway	Read Only	The current IP gateway address	IPv4 address
Current DNS Servers	Read only	The IP addresses of the current DNS servers	Comma separated list of IPv4 addresses
Static Addresses	Read/Write	Status IP address and subnet mask when DHCP disabled	{IPv4 address}/{Subnet Mask}
Static Gateway	Read/Write	Static gateway address when DHCP disabled	IPv4 address
Static DNS Servers	Read/Write	The IP addresses of the static DNS servers	Comma separated list of IPv4 addresses

Changing Networking Settings

The network can be configured to use either DHCP or a static configuration. To enable DHCP on Network Interface 0:

```
NETWORK INTERFACE 0:↵
```

```
Dynamic IP: true↵
```

```
↵
```

```
ACK↵
```

```
↵
```

```
NETWORK INTERFACE 0:↵
```

```
Dynamic IP: true↵
```

```
↵
```

To set a fixed IP address, supply all static parameters:

```
NETWORK INTERFACE 0:↵
```

```
Dynamic IP: false↵
```

```
Static Addresses: 192.168.1.2/255.255.255.0↵
```

```
Static Gateway: 192.168.1.1↵
```

```
Static DNS Servers: 8.8.8.8, 8.8.4.4↵
```

```
↵
```

```
ACK↵
```

```
↵
```

```
NETWORK INTERFACE 0:↵
```

```
Dynamic IP: false↵
```

```
Static Addresses: 192.168.1.2/255.255.255.0↵
```

```
Static Gateway: 192.168.1.1↵
```

```
Static DNS Servers: 8.8.8.8, 8.8.4.4↵
```

```
↵
```

Changing network settings may cause the IP connection to be dropped.

UI Settings Block

The UI settings block contains the front panel LCD and monitor output settings for the connected Web Presenter.

Block Syntax

```
UI SETTINGS:↵
```

```
Available Locales: en_US.UTF-8, zh_CN.UTF-8, ja_JP.UTF-8, ko_KR.UTF-8, es_
ES.UTF-8, de_DE.UTF-8, fr_FR.UTF-8, ru_RU.UTF-8, it_IT.UTF-8, pt_BR.UTF-8,
tr_TR.UTF-8, pl_PL.UTF-8, uk_UA.UTF-8↵
```

```
Current Locale: en_US.UTF-8↵
```

```
Available Audio Meters: PPM -18dB, PPM -20dB, VU -18dB, VU -20dB↵
```

```
Current Audio Meter: PPM -20dB↵
```

```
↵
```

Parameters

Key	Read/Write	Description	Valid Values
Available Locales	Read only	The locales available in the Web Presenter	Comma separated list of locales
Current Locale	Read/Write	The current locale for Web Presenter	Refer to the locales from the Available Locales field
Available Audio Meters	Read only	The available audio meters supported by the Web Presenter	Comma separated list of audio meter types
Current Audio Meter	Read/Write	The current audio meter	Refer to the audio meters from the Available Audio Meters field

Stream Settings Block

The stream settings block contains the stream configuration for the connected Web Presenter.

Block syntax

This example shows the output for a connected Web Presenter. The stream settings prefixed with Current show the active stream settings and are writable. The stream settings prefixed by Available show the available stream settings for the device or platform and are read-only. To view the available servers or quality levels for a stream service, the Current Platform stream setting should be set first.

```
STREAM SETTINGS:↵
Available Video Modes: Auto, 1080p23.98, 1080p24, 1080p25, 1080p29.97,
1080p30, 1080p50, 1080p59.94, 1080p60, 720p25, 720p30, 720p50, 720p60↵
Video Mode: 1080p59.94↵
Current Platform: YouTube↵
Current Server: Primary↵
Current Quality Level: Streaming Medium↵
Stream Key: abc1-def2-ghi3-jkl4-mno5↵
Password: ↵
Current URL: srt://192.168.8.51
Customizable URL: true
Available Default Platforms: YouTube RTMP, YouTube SRT (Beta), Facebook,
Twitch, Twitter, Restream.IO, Vimeo, BoxCast, CastR, AfreecaTV, Bilibili,
DouYu, Weibo↵
Available Custom Platforms: My Platform↵
Available Servers: Primary, Secondary↵
Available Quality Levels: HyperDeck High, HyperDeck Medium, HyperDeck Low,
Streaming High, Streaming Medium, Streaming Low↵
↵
```

Parameters

Key	Read/Write	Description	Valid Values
Available Video Modes	Read only	The video modes available in the Web Presenter	Comma separated list of video modes
Video Mode	Read/Write	The current video mode	Refer to the video modes from the <i>Available Video Modes</i> field
Current Platform	Read/Write	The selected streaming platform	Refer to the platforms from the <i>Available Default Platforms</i> and <i>Available Custom Platforms</i> fields
Current Server	Read/Write	The current server for the streaming platform	Server is dependent on selected Current Platform
Current Quality Level	Read/Write	The current streaming quality level	Quality level is dependent on selected Current Platform
Stream Key	Read/Write	The stream key for the streaming platform	String
Password	Read/Write	The passphrase for an encrypted SRT stream	String
Current URL	Read/Write	The current URL for the streaming platform. This field is writable if <i>Customizable URL</i> field is true.	String
Customizable URL	Read only	A boolean specifying whether custom URLs are supported by the streaming platform	true - Custom URLs are supported false - Custom URLs are not supported
Available Default Platforms	Read only	The available default streaming platforms	Comma separated list of default platforms
Available Custom Platforms	Read only	The custom streaming platforms loaded in the Web Presenter	Comma separated list of custom platforms
Available Servers	Read only	The available servers for the selected streaming platform	Comma separated list of servers
Available Quality Levels	Read only	The available quality levels for the selected streaming platform	Comma separated list of quality levels

Changing Stream Settings

The stream settings can be changed by providing a stream settings block. The following is an example of streaming a 1080p59.94 input on Twitch with a medium stream quality.

```

STREAM SETTINGS:↵
Video Mode: 1080p59.94↵
Current Platform: Twitch↵
Current Server: US West: Los Angeles, CA↵
Current Quality Level: Streaming Medium↵
Stream Key: live_123456789_1aB2cD3eF4gH5iJ6kL7mN8oP9qR0sT↵
↵
ACK↵
↵
STREAM SETTINGS:↵
Video Mode: 1080p59.94↵
Current Platform: Twitch↵
Current Server: US West: Los Angeles, CA↵
Current Quality Level: Streaming Medium↵
Stream Key: live_123456789_1aB2cD3eF4gH5iJ6kL7mN8oP9qR0sT↵
↵

```

Stream XML Block

The stream XML block allows users to configure the Web Presenter with a custom configuration file in XML format.

Block syntax

The following example shows an XML file - Custom.xml has been loaded to configure the stream settings in the Web Presenter.

```
STREAM XML:↵  
Files: Custom.xml↵  
↵
```

Parameters

Key	Read/Write	Description	Valid Values
Files	Read/Write	The XML files loaded in Web Presenter	Comma separated list of filenames
Action	Write only	The stream XML action	Remove Remove All

Adding a Stream XML file

An XML file can be loaded onto a Web Presenter by sending the stream xml command with a filename, then provide the contents of the XML file. After adding the XML file, the Available Custom Platforms field in the STREAM SETTINGS block will be updated with the new platforms, however the Current items will remain unchanged.

For the Stream XML block to be parsed correctly, any blank lines should be removed from the XML files.

Refer to the `Blackmagic Stream XML File Format` section in this manual for description of the Stream XML file format.

```
STREAM XML Custom.xml:↵  
<?xml version="1.0" encoding="UTF-8"?>↵  
<streaming>↵  
    <service>↵  
        <name>My Custom Platform</name>↵  
        ...  
    </service>↵  
</streaming>↵  
↵  
ACK↵  
↵  
STREAM XML Custom.xml:↵  
<?xml version="1.0" encoding="UTF-8"?>↵  
<streaming>↵  
    <service>↵  
        <name>My Custom Platform</name>↵  
        ...  
    </service>↵  
</streaming>↵  
↵
```

```
STREAM XML:↵
Files: Custom.xml↵
↵
STREAM SETTINGS:↵
Available Custom Platforms: My Custom Platform↵
↵
```

Removing a Stream XML file

An XML file can be removed from the Web Presenter by sending the stream xml command with the remove action.

```
STREAM XML:↵
Action: Remove↵
Files: Custom.xml↵
↵
ACK↵
↵
STREAM XML:↵
Files:↵
↵
STREAM SETTINGS:↵
Available Custom Platforms:↵
↵
```

Removing all Stream XML files

All XML files can be removed from the Web Presenter by sending the stream xml command with the remove all action. In the example, following the remove all action, the loaded stream XML files and available custom platforms are both displayed as empty.

```
STREAM XML:↵
Action: Remove All↵
↵
ACK↵
↵
STREAM XML:↵
Files: ↵
↵
STREAM SETTINGS:↵
Available Custom Platforms:↵
↵
```

Stream State Block

The stream state block provides the streaming status of the Web Presenter.

The Web Presenter server will send a stream state block update whenever there is a change to the Status field. Due to frequency of changes to Duration, Bitrate and Cache Used fields, these fields need to be polled by the client by requesting a Stream State block.

Block syntax

```
STREAM STATE:↵↵
Status: Idle↵↵
Bitrate: 161672↵↵
Duration: 00:00:00:00↵↵
Cache Used: 0↵↵
↵↵
```

Parameters

Key	Read/Write	Description	Valid Values
Status	Read only	The stream state of the Web Presenter, updated when the stream status changes	Idle Connecting Streaming Interrupted
Action	Write only	The Web Presenter stream state action.	Start Stop
Duration	Read only	The duration of the active stream	String in format of DD:HH:MM:SS
Bitrate	Read only	The bitrate of the active stream	Integer bits per second
Cache Used	Read only	The current usage of the streaming cache	Integer as a percentage

Starting Stream

The stream is started by providing a stream state block with start action.

```
STREAM STATE:↵↵
Action: Start↵↵
↵↵
ACK↵↵
↵↵
STREAM STATE:↵↵
Status: Connecting↵↵
↵↵
STREAM STATE:↵↵
Status: Streaming↵↵
↵↵
```

Stopping stream

The stream is stopped by providing a Stream State block with stop action.

```
STREAM STATE:↵↵
Action: Stop↵
↵
ACK↵
↵
STREAM STATE:↵↵
Status: Idle↵
↵
```

Audio Settings Block

The Audio Settings block contains the audio configuration for the connected Web Presenter.

Block syntax

This example shows the output for a connected Web Presenter. The stream settings prefixed with Current show the active audio settings and are writable. The stream settings prefixed by Available show the available audio settings for the device or platform and are read-only.

```
AUDIO SETTINGS:↵↵
Current Monitor Out Audio Source: Auto↵
Available Monitor Out Audio Sources: Auto, SDI In, Remote Source↵
↵
```

Parameters

Key	Read/Write	Description	Valid Values
Current Monitor Out Audio Source	Read/Write	The current audio source on the monitor output	Refer to the audio sources from the <i>Available Monitor Out Audio Sources</i> field
Available Monitor Out Audio Sources	Read only	The available audio sources that can be routed to the monitor output	Comma separated list of audio sources

Changing Audio Settings

The audio settings can be changed by providing an audio settings block. The following is an example of setting the monitor output audio source to remote.

```
AUDIO SETTINGS:↵↵
Current Monitor Out Audio Source: Remote Source↵
↵
ACK↵
↵
AUDIO SETTINGS:↵↵
Current Monitor Out Audio Source: Remote Source↵
↵
```

Shutdown Block

The Shutdown block provides power control of the Web Presenter. The Shutdown block is write-only and not presented in the preamble.

Parameters

Key	Read/Write	Description	Valid Values
Action	Write only	The Web Presenter shutdown action.	Reboot Factory Reset

Reboot

The Web Presenter can be rebooted by providing a Shutdown block with reboot action.

```
SHUTDOWN:↵
```

```
Action: Reboot↵
```

```
↵
```

```
ACK↵
```

```
↵
```

On reboot action, the Web Presenter server will be stopped and clients will be disconnected.

Factory Reset

The Web Presenter can be factory reset by providing a Shutdown block with factory reset action. On factory reset action, all settings are set to factory defaults.

```
SHUTDOWN:↵
```

```
Action: Factory Reset↵
```

```
↵
```

```
ACK↵
```

```
↵
```

Blackmagic Streaming XML Format

Overview

The Blackmagic Streaming XML allows users to specify streaming services in addition to the default services provided by the Web Presenter.

The Streaming XML can be loaded into the Web Presenter with Web Presenter Setup. Refer to the 'Using Web Presenter Setup' section earlier in this manual

The Streaming XML can also be loaded by copying the contents into the Stream XML block with the Blackmagic Web Presenter Ethernet Protocol.

The following is a minimal example of a Streaming XML file:

```
<?xml version="1.0" encoding="UTF-8"?>
<streaming>
  <service>
    <name>My Streaming Service</name>
    <servers>
      <server>
        <name>My Streaming Server</name>
        <url>rtmp://my.streaming-server.com/live</url>
      </server>
    </servers>
    <profiles>
      <profile>
        <name>My Streaming Quality</name>
        <config resolution="1080p" fps="60" codec="H264">
          <bitrate>7500000</bitrate>
        </config>
      </profile>
    </profiles>
  </service>
</streaming>
```

Streaming XML Definition

The Streaming XML file follows standard XML format and shall begin with XML declaration.

```
<?xml version="1.0" encoding="UTF-8"?>
```

Streaming Element

The Streaming XML file shall be contained by the <streaming> element. The <streaming> element will consist of 1 or more <service> child elements.

The following is an example of a <streaming> element block that defines 2 streaming services.

```
<streaming>
  <service>
    <name>Service 1</name>
    <!-- Streaming settings for "Service 1" -->
  </service>
  <service>
    <name>Service 2</name>
    <!-- Streaming settings for "Service 2" -->
  </service>
</streaming>
```

Service Element

The <service> element provides a description of the streaming service. If multiple streaming services are used, it is possible to define multiple <service> elements within each <streaming> element block.

The following is an example of a <service> element block in the Stream XML file.

```
<streaming>
  <service customizable-url="true">
    <name>My Streaming Service</name>
    <key>abc1-def2-ghi3-jkl4-mno5</key>
    <servers>
      <!-- Streaming server settings -->
    </servers>
    <profiles default="Streaming High">
      <!-- Streaming quality settings-->
    </profiles>
    <credentials>
      <!-- Streaming username and password settings -->
    </credentials>
  </service>
  <!-- <service> elements blocks for other streaming services -->
</streaming>
```

Attributes

Attribute	Optional/Required	Description
customizable-url	Optional	The service supports specifying custom URLs - supported = "true" or unsupported = "false" (default)

Child Elements

Element	Optional/Required	Description
<name>	Required	The name of the streaming service
<key>	Optional	The stream key for the streaming service
<servers>	Optional	The RTMP/SRT server settings of the streaming service (see below). May be omitted if customizable-url is true.
<profiles>	Required	The quality settings of the streaming service (see below)
<credentials>	Optional	The username and password of the streaming service (see below)

Servers Element

The <servers> element consists of 1 or more <server> child elements for defining the streaming server(s). The <servers> element is a required child of the <service> element. Defining multiple servers allows specifying localized and/or backup servers within a single XML description

The following is an example of a <servers> element block that defines a primary and secondary URL for the SRT server.

```
<service>
  ...
  <servers>
    <server group="Primary">
      <name>My Streaming Service Server</name>
      <url>srt://srt.my-streaming-service.com:2010</url>
      <srt-extensions>
        ...
      </srt-extensions>
    </server>
    <server group="Secondary">
      <name>My Streaming Service Backup Server</name>
      <url>srt://srt-backup.my-streaming-service.com:2010</url>
      <srt-extensions>
        ...
      </srt-extensions>
    </server>
    <!-- Additional <server> element blocks defining other
servers for streaming service -->
  </servers>
  ...
</service>
```

Attributes

Attribute	Optional/Required	Description
group	Optional	The logical grouping for the server

Child Elements

Element	Optional/Required	Description
<name>	Required	The name of the RTMP/SRT streaming server
<url>	Required	The URL of the RTMP/SRT streaming server
<srt-extensions>	Optional	Extended service block specific to SRT streaming server (see below)

SRT Extensions Element

The <srt-extensions> element consists of 1 or more child elements that define SRT specific parameters.

The following is an example of a <srt-extensions> element block for a primary stream identifier.

```
<service>
  ...
  <servers>
    <server group="Primary">
      ...
      <srt-extensions>
        <stream-id>
          <item key="copy" value="0"/>
        </stream-id>
      </srt-extensions>
    </server>
  </servers>
  ...
</service>
```

Child Elements

Element	Optional/Required	Description
<stream-id>	Required	Provides element with custom parameters for the stream ID. Each child element of stream-id has 1 or more item elements with a key/value pair.

Profiles Element

The <profiles> element consists of 1 or more <profile> child elements that define streaming quality. The <profiles> element is a required child of the <service> element. Defining multiple profiles allows specifying custom bitrates for different streaming qualities.

The following is an example of a <profiles> element block that defines 3 profiles.

```
<service>
  ...
  <profiles default="Streaming High">
    <profile>
      <name>Streaming High</name>
      <!-- Define <config> elements to specify target
bitrates for Streaming High profile -->
    </profile>
    <profile>
      <name>Streaming Medium</name>
      <!-- Define <config> elements to specify target
bitrates for Streaming Medium profile -->
    </profile>
  </profiles>
  ...
</service>
```

Attributes

Attribute	Optional/Required	Description
default	Optional	The name of the default profile

Child Elements

Element	Optional/Required	Description
<name>	Required	The name of the profile
<config>	Required	Video mode dependent quality settings for profile (see below)

Config Element

The <config> element defines a mapping between the video resolution and frame rate and the target bitrate for the quality level. The <config> element is a child of the <profile> element.

The following is an example of a <config> element block for setting the target bitrate for a high quality stream with 720p60 and 1080p60 video inputs.

```
<profile>
  <name>Streaming High</name>
  <config resolution="720p" fps="60" codec="H264">
    <bitrate>6000000</bitrate>
    <audio-bitrate>128000</audio-bitrate>
  </config>
  <config resolution="1080p" fps="60" codec="H264">
    <bitrate>8000000</bitrate>
    <audio-bitrate>128000</audio-bitrate>
  </config>
  <!-- <config> elements for other resolutions and frame rates -->
</profile>
```

Attributes

Attribute	Optional/Required	Description
resolution	Required	The resolution of the streaming video mode
fps	Required	The frame rate of the streaming video mode (frames per second)
codec	Optional	The codec for encoding the streaming video - "H264" (default) or "H265"

Child Elements

Element	Optional/Required	Description
<bitrate>	Required	The target bitrate of the streaming video (bits per second)
<audio-bitrate>	Optional	The target bitrate of the streaming audio (bits per second)

The supported streaming quality bitrates can be found in section `Using Web Presenter Setup` section earlier in this manual.

TIP For each <config> element block, choose a maximum resolution and fps to cover all video modes for the target bitrate. For example, defining a <config> element with resolution="1080p" and fps = "30" will apply for video modes 1080p23.98, 1080p24, 1080p25, 1080p29.97 and 1080p30.

For audio bitrate, only 128 Kb/s is supported.

Credentials Element

The <credentials> element allows specifying an RTMP session username and password if required by the service. The <credentials> element is an optional child to service element.

The following is an example of a <credentials> element block that defines a username and password for the streaming service.

```
<service>
  ...
  <credentials>
    <username>myusername</username>
    <password>abcd1234</password>
  </credentials>
  ...
</service>
```

Child Elements

Element	Optional/Required	Description
<username>	Required	RTMP session username
<password>	Required	RTMP/SRT session password

Yardıım

Yardıım İin

Yardıım almanın en hızlı yolu, Blackmagic Design online destek sayfalarına girip, Blackmagic Web Presenter'iniz için en son destek kaynaklarını incelemenizdir.

Blackmagic Design Online Destek Sayfaları

En güncel kılavuza, www.blackmagicdesign.com/tr/support adresindeki BlackmagicDesign destek merkezinden erişebilirsiniz.

Blackmagic Design Forum

İnternet sitemizdeki Blackmagic Design forum sayfası, daha fazla bilgi ve yaratıcı fikirler için ziyaret edebileceğiniz faydalı bir kaynaktır. Burası, yardıım almanız için daha hızlı bir yol olabilir çünkü, sorularınız için, başka deneyimli kullanıcılar ya da Blackmagic Design çalışanları tarafından verilen yanıtları bulabilir ve böylelikle çalışmalarınıza devam edebilirsiniz. Foruma <https://forum.blackmagicdesign.com> adresinden ulaşabilirsiniz.

Blackmagic Design Destek Hizmetiyle İrtibat

Aradığınız yardıımı destek kaynaklarında ya da forumda bulamadığınız durumda, lütfen destek sayfamıza girerek "bize e-posta gönderin" butonunu tıklayarak e-post yoluyla destek talebinde bulunun. Bunun yerine, destek sayfasındaki "yerel destek ekibinizi bulun" butonunu tıklayın ve size en yakın olan Blackmagic Design destek ofisini arayın.

Mevzuata İlişkin Bildirimler



Avrupa Birliğinin elektrikli ve elektronik cihazlara dair atık kontrol yönetmeliği.

Ürün üzerindeki sembol, bu ekipmanın başka atık malzemelerle bertaraf edilmemesi şartını belirler. Atık ekipmanlarınızı bertaraf edebilmemiz için, geri dönüşümünü sağlamak üzere, belirlenmiş toplama noktasına teslim edilmeleri gerekmektedir. Bertaraf anında atık cihazlarınızın ayrı olarak toplanması ve geri dönüşümü, doğal kaynakların korunmasına yardımcı olacaktır ve insan sağlığını ve çevreyi koruyucu bir şekilde geri dönüşümünü sağlayacaktır. Atık ekipmanlarınızı geri dönüşüm için nereye teslim edebileceğiniz konusunda daha fazla bilgi için, lütfen yerel belediyenizin geri dönüşüm şubesini ya da ürünü satın aldığınız satış bayisini arayınız.



Bu cihaz, test edilmiş ve Federal İletişim Komisyonu (FCC) koşullarının 15. bölümü doğrultusunda A Sınıfı dijital cihazların sınırlarıyla uyumlu olduğu tespit edilmiştir. İlgili sınırlar, bu cihaz ticari bir ortamda çalıştırıldığında, zararlı müdahalelere karşı makul koruma sağlamaları amacıyla tasarlanmıştır. Bu ekipman, radyo frekans enerjisi üretir, kullanır ve saçabilir ve talimatlar doğrultusunda kurulmadığı ve kullanılmadığı takdirde, radyo iletişimlerine zararlı müdahaleye yol açabilir. Bu ürünün bir yerleşim bölgelerinde çalıştırılması zararlı müdahaleye yol açabilir. Bu durumda, müdahalenin düzeltilmesi için ilgili maliyeti kullanıcı karşılamak zorundadır.

Bu cihazın çalıştırılması aşağıdaki iki şarta bağlıdır:

- 1 Bu cihaz, zararlı müdahaleye sebebiyet vermemelidir.
- 2 Bu cihaz, arzu edilmeyen bir çalışma şekline yol açacak müdahale de dahil olmak üzere, maruz kaldığı her türlü müdahaleyi kabul etmelidir.



R-R-BMD-20201201001
R-R-BMD-20201201002



ISED Kanada Beyannamesi

Bu cihaz, A Sınıfı dijital cihazlar için Kanada standartlarıyla uyumludur.

Bu cihaza yapılacak herhangi bir değişiklik veya kullanım amacı dışında kullanılması, bu standartlara uyumluluğunu hükümsüz kılabilir.

HDMI arayüzlerine bağlantı, yüksek kaliteli korumalı HDMI kablolarıyla yapılmalıdır.

Bu cihaz, ticari ortamda kullanım amacına uygunluk için test edilmiştir. Cihaz ev ortamında kullanıldığında, radyo parazitine neden olabilir.

Güvenlik Bilgileri

Bu cihaz, koruyucu topraklama bağlantısı olan bir şebeke prizine takılmalıdır.

Elektrik çarpması riskine karşı, bu cihaz damlayan veya sıçrayan suya maruz bırakılmamalıdır.

Bu ekipman çevresel ısı 40° C'ye kadar olan tropikal ortamlarda kullanılmaya uygundur.

Saklama için ortam sıcaklığı -20 °C ile 60°C arasında ve bağıl nem 0% ila 90% yoğuşmasız olmalıdır.

Cihazın çevresinde yeterli havalandırma olduğundan ve hava akımının kısıtlanmadığından emin olun.

Rafa monte ederken, hava akımının bitişik cihazlardan dolayı kısıtlanmadığından emin olun.

Ürünün içinde, kullanıcı tarafından tamir edilebilecek hiçbir parça bulunmamaktadır. Gerekli tamiratları, yerel Blackmagic Design servis merkezine yönlendirin.



Deniz seviyesinden yüksekliğin 2000m'yi aşmadığı yerlerde kullanın.

Kaliforniya Eyaleti Beyannamesi

Bu ürün; plastik parçaları dahilinde, eser miktarda polibromine bifenil gibi kimyasal maddelere sizi maruz bırakabilir. Kaliforniya eyaletinde, bu maddelerin kansere, doğum kusurlarına veya başka üreme bozukluklarına sebebiyet verdiği bilinmektedir.

Daha fazla bilgi için www.P65Warnings.ca.gov adresini ziyaret ediniz.

Garanti

36 Ay Sınırlı Garanti

Blackmagic Design şirketi, satın alındığı tarihten itibaren 12 aylık süre içinde malzeme ve işçilik bakımından arızasız olacak konektörler, kablolar, fiber optik modüller, elektrik sigortaları ve bataryalar dahil olmamak şartıyla, Blackmagic Web Presenter ünitelerinin satın alındığı tarihten itibaren malzeme ve işçilik bakımından 36 ay boyunca arızasız olacağına garanti sunmaktadır. Bu garanti süresi içinde üründe bir arıza ve kusur söz konusu olursa, Blackmagic Design kendi seçimi doğrultusunda, arızalı ürünü parça ve işçilik bedeli talep etmeksizin tamir edecektir veya yenisiyle değiştirecektir.

Bu garanti kapsamındaki hizmetten yararlanmak için, kusur ve hataya ilişkin garanti süresi sona ermeden, Müşteri Blackmagic Design'i bilgilendirmeli ve söz konusu hizmetin sağlanması için uygun düzenlemeleri yapmalıdır. Blackmagic Design tarafından özel belirlenmiş ve yetkilendirilmiş bir hizmet merkezine arızalı ürünün ambalajlanarak nakliyesi, Müşteri'nin sorumluluğudur ve nakliye ücretleri, peşin ödenmiş olmalıdır. Herhangi bir sebepten dolayı bize iade edilen ürünlerin; tüm nakliye, sigorta, gümrük vergileri, vergi ve tüm diğer masrafların ödenmesi, Müşteri sorumluluğu altındadır.

Bu garanti; yanlış kullanım ya da yanlış veya kusurlu bakımdan kaynaklanan herhangi bir arızayı, bozukluğu ya da hasarı kapsamaz. Blackmagic Design, burada açıklanan durumlarda bu garanti kapsamında hizmet sağlamak zorunda değildir: a) Blackmagic Design temsilcileri haricindeki başka personelin ürünü kurma, tamir etme ya da bakımını yapma girişimlerinden kaynaklanan hasarın tamiri, b) uygun olmayan kullanım veya uyumlu olmayan ekipmanlara bağlamaktan kaynaklanan hasarın tamiri, c) Blackmagic Design ürünü olmayan parçaların ya da malzemenin kullanımından kaynaklanan hasarın ya da arızanın tamiri ya da d) Modifiye veya başka ürünlerle entegre edilmiş bir ürünü; söz konusu modifikasyon ya da entegrasyonun, gereken tamiratın süresini uzattığı ya da ürün bakımını zorlaştırdığı durumlarda tamir edilmesi. BU GARANTİ, BLACKMAGIC DESIGN TARAFINDAN VERİLMİŞTİR VE AÇIK YA DA ZİMNİ, HERHANGİ BİR GARANTİNİN YERİNİ TUTAR. BLACKMAGIC DESIGN VE SATICILARI, ZİMNİ TİCARİ UYGUNLUK GARANTİSİNİ YA DA ÖZEL BİR AMACA UYGUNLUK GARANTİSİNİ KABUL ETMEZ. KUSURLU BİR ÜRÜNÜN TAMİRİ VEYA DEĞİŞTİRİLMESİ, BLACKMAGIC DESIGN'İN MÜŞTERİLERİNE SUNDUĞU TAM VE MÜNHASİR ÇÖZÜMDÜR. BLACKMAGIC DESIGN YA DA SATICILARININ OLABİLECEK HASARLAR HAKKINDA ÖNCEDEN BİLGİSİ OLMASINI GÖZETMEKSİZİN, ÜRÜNDE DOLAYLI, ÖZEL, TESADÜFİ YA DA NETİCE OLARAK ORTAYA ÇIKAN HERHANGİ BİR HASAR İÇİN, BLACKMAGIC DESIGN SORUMLU DEĞİLDİR. BLACKMAGIC DESIGN, MÜŞTERİLER TARAFINDAN EKİPMANIN YASAL OLMAYAN HERHANGİ BİR KULLANIMINDAN SORUMLU DEĞİLDİR. BLACKMAGIC DESIGN, BU ÜRÜNÜN KULLANIMINDAN KAYNAKLANAN HERHANGİ BİR HASARDAN SORUMLU DEĞİLDİR. BU ÜRÜNÜN ÇALIŞTIRILMASINDAN DOĞAN RİSK, KULLANICININ KENDİSİNE AİTTİR.

© Telif Hakkı Saklıdır 2023 Blackmagic Design. Tüm hakları saklıdır. 'Blackmagic Design', 'DeckLink', 'HDLink', 'Workgroup Videohub', 'Multibridge Pro', 'Multibridge Extreme', 'Intensity' ve 'Leading the creative video revolution', ABD ve diğer ülkelerde tescil edilmiş ticari markalardır. Diğer tüm şirket ve ürün isimleri, bağlantılı oldukları ilgili şirketlerin/firmaların ticari markaları olabilir. Thunderbolt ve Thunderbolt logosu ABD ve/ya başka ülkelerdeki Intel Corporation'un ticari markalarıdır.

Blackmagic Web Presenter





Szanowny kliencie,

Dziękujemy za zakup Blackmagic Web Presenter.

Blackmagic Web Presenter podłącza się bezpośrednio do dowolnego urządzenia SDI, konwertuje sygnał do formatu H.264 i umożliwia przesyłanie go do popularnych serwisów streamingowych, takich jak YouTube Live, Facebook Live czy Twitch. Za pomocą opcjonalnego ATEM Streaming Bridge można również przesyłać z punktu do punktu sygnał wideo o jakości nadawczej. Dzięki temu przesyłanie sygnału wideo świetnej jakości do odległych lokalizacji za pośrednictwem internetu jest bardzo proste!

Niniejsza instrukcja obsługi zawiera wszystkie informacje potrzebne do rozpoczęcia pracy z Blackmagic Web Presenter oraz do korzystania ze wszystkich funkcji i elementów sterujących, w tym do skonfigurowania wszystkiego dla YouTube Live, Facebook Live, Twitch, Zoom, Skype i innych.

Najnowszą wersję niniejszej instrukcji oraz aktualizacje wewnętrznego oprogramowania Blackmagic Web Presenter można znaleźć na stronie pomocy technicznej pod adresem www.blackmagicdesign.com/pl. Po pobraniu oprogramowania zarejestruj się, podając swoje dane. Dzięki temu będziemy mogli Cię poinformować, gdy dostępna będzie aktualizacja.

Ciągle pracujemy nad nowymi funkcjami i unowocześnieniami, więc zależy nam, abyś podzielił się z nami swoimi wrażeniami.

Grant Petty

Dyrektor Generalny Blackmagic Design

Contents

Rozpoczęcie pracy	588
Panel przedni Web Presentera	591
Wyświetlacz LCD	592
Wyjście monitora	593
Konfiguracja Web Presentera	598
Zakładka transmisji na żywo	599
Zakładka konfiguracji	602
Ustawienia sieci	603
Ustawianie udostępniania internetu dla bezpośredniej transmisji	603
Transmisja za pomocą smartfonu	604
Blackmagic Web Presenter jako kamera internetowa	604
Konfiguracja Open Broadcastera	604
Tworzenie linków wideo z ATEM Streaming Bridge	607
Tworzenie pliku XML	608
Przesyłanie pliku XML	608
Tally, talkback i sterowanie kamerą	609
Podłączanie URSA Broadcast G2	610
Blackmagic Universal Rack Shelf	611
Zawartość	611
Montaż urządzenia w racku	612
Mocowanie panelu zasłepiającego 1/6	612
Mocowanie panelu zasłepiającego 1/3	612
Aktualizacja oprogramowania wewnętrznego	613
Developer Information	614
Blackmagic Web Presenter Ethernet Protocol	614
Protocol Blocks	616
Blackmagic Streaming XML Format	627
Overview	627
Streaming XML Definition	627
Pomoc	634
Wymogi prawne	635
Informacje dotyczące bezpieczeństwa	636
Gwarancja	637

Rozpoczęcie pracy

Rozpoczęcie pracy z Blackmagic Web Presenter jest szybkie i proste! Wystarczy tylko włączyć zasilanie, doprowadzić sygnał wideo i audio, podłączyć urządzenie do komputera, a następnie połączyć się z internetem.

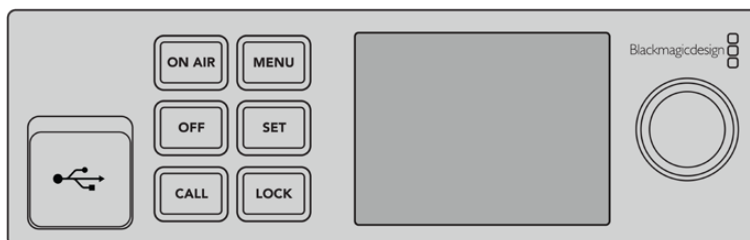

Przedni panel Blackmagic Web Presenter

Podłączanie zasilania

Podłącz standardowy kabel zasilający IEC do wejścia zasilania w Blackmagic Web Presenter na tylnym panelu.

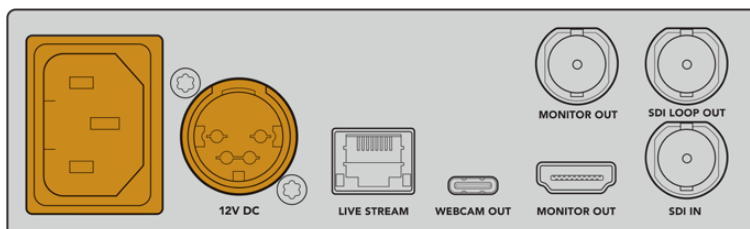

Blackmagic Web Presenter może być zasilany za pomocą wejścia zasilania IEC lub 12V DC

Web Presenter posiada również dodatkowe wejście zasilania 12V DC. Wejścia tego można użyć w celu podłączenia zasilania zewnętrznego lub redundancji za pomocą zewnętrznego zasilacza, np. zasilacza UPS lub zewnętrznego akumulatora 12V.

Podłączanie wideo i audio

Podłącz źródło wideo do wejścia SDI urządzenia Blackmagic Web Presenter. Po podłączeniu wideo będzie ono wyświetlane na wbudowanym wyświetlaczu LCD Web Presentera. Dźwięk jest wbudowany w sygnał wideo SDI, co można potwierdzić, obserwując mierniki dźwięku na ekranie LCD.

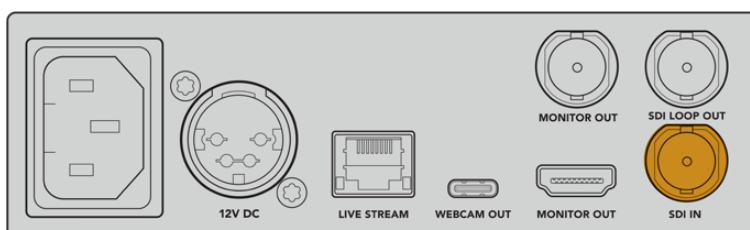

Podłącz wideo do wejścia SDI w Blackmagic Web Presenter

Blackmagic Web Presenter obsługuje 12G-SDI i automatycznie przełącza się między HD i Ultra HD aż do 2160p60, gdy zmienia się wejście wideo. Podczas gdy Blackmagic Web Presenter 4K może przesyłać strumień w rozdzielczości Ultra HD, Blackmagic Web Presenter HD może odbierać praktycznie każdy sygnał wideo i konwertować go do rozdzielczości 1080p.

Podłączanie monitora

Podłącz telewizor HDMI lub monitor SDI do jednego z wyjść monitorowych. Umożliwia to monitorowanie transmisji i obserwowanie ważnych informacji o stanie, które są stale aktualizowane wraz ze strumieniem wideo. Więcej informacji na temat korzystania z wyjścia monitorowego można znaleźć w rozdziale „Wyjście monitora”.

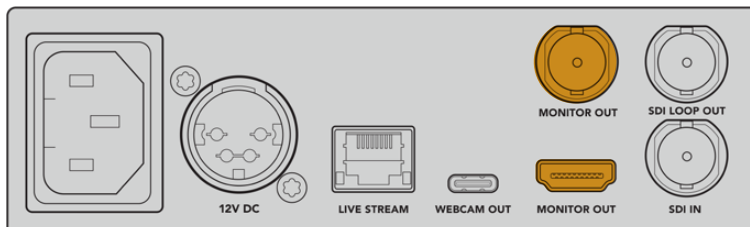

Podłącz monitor do wyjścia monitora w Web Presenter

Podłączanie do komputera przez USB

Podłącz Web Presenter do komputera za pomocą portu USB typu C znajdującego się na przednim lub tylnym panelu. Te porty USB służą do aktualizacji urządzenia i konfigurowania go za pomocą narzędzia Blackmagic Web Presenter Setup. Po skonfigurowaniu programu Web Presenter po raz pierwszy, można odłączyć urządzenie od komputera.

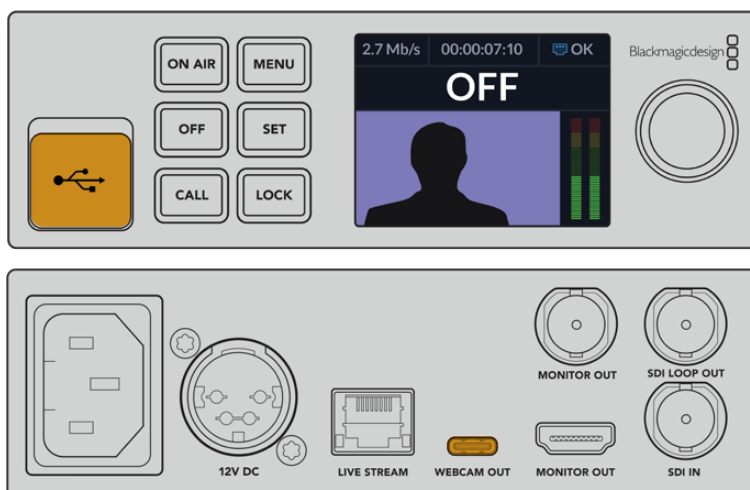

Podłącz Blackmagic Web Presenter do komputera za pomocą portu USB znajdującego się na przednim lub tylnym panelu.

Podłączanie do Internetu

Podłącz urządzenie Blackmagic Web Presenter do Internetu, podłączając kabel sieciowy z portu Ethernet „strumienia na żywo” do routera internetowego lub przełącznika sieciowego.

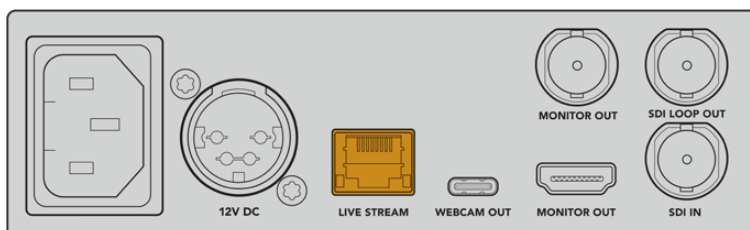

Podłącz Blackmagic Web Presenter do sieci przez port Ethernet na tylnym panelu

Ustawianie transmisji na żywo

Twoje urządzenie Web Presenter możesz teraz skonfigurować do przesyłania strumieniowego za pośrednictwem dowolnej platformy streamingowej, takiej jak YouTube Live, Facebook Live, Twitch i innych. W tym przykładzie skonfigurujemy transmisję na żywo w serwisie YouTube.

- 1 Skopiuj swój klucz transmisji z konta YouTube Studio.
- 2 Pobierz narzędzie Blackmagic Web Presenter Setup ze strony www.blackmagicdesign.com/pl/support i zainstaluj je na swoim komputerze. To oprogramowanie umożliwia skonfigurowanie ustawień transmisji strumieniowej po raz pierwszy.
- 3 Uruchom narzędzie Blackmagic Web Presenter Setup i przejdź do strony **Transmisja na żywo**.
- 4 Ustaw na platformę YouTube, a serwer na **Główny**. Wklej klucz transmisji YouTube w polu **Klucz** i wybierz jakość strumienia. Kliknij **Zapisz**.
- 5 Teraz możesz rozpocząć transmisję na cały świat. Kliknij przycisk **ON AIR** lub naciśnij przycisk **ON AIR** na panelu przednim urządzenia. Po zakończeniu produkcji naciśnij przycisk **OFF**, aby zakończyć transmisję.

Korzystanie z protokołu strumieniowego SRT

Bezpieczny i niezawodny protokół transmisji (SRT) zapewnia mniejszą latencję strumieniowania w porównaniu do RTMP. SRT poprawia również bezpieczeństwo poprzez użycie hasła, które jest jak klucz szyfrujący.

Po wybraniu wersji protokołu SRT usługi strumieniowej skopiuj hasło i klucz transmisji strumieniowej z konta transmisji strumieniowej i wklej je w polach **Key** i **Passphrase** narzędzia Blackmagic Web Presenter Setup.

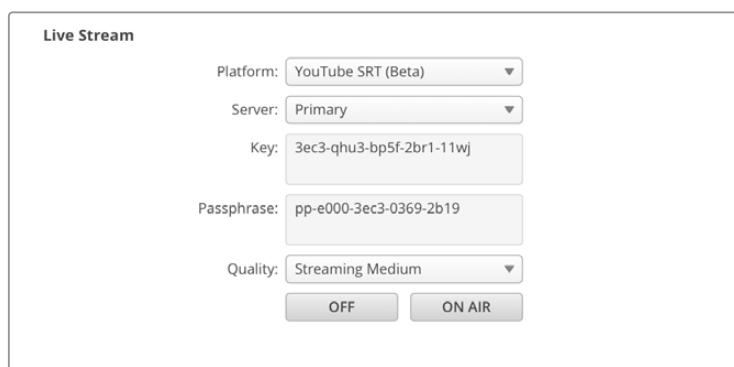

The screenshot shows a configuration window titled "Live Stream". It contains the following fields and controls:

- Platform: YouTube SRT (Beta) (dropdown menu)
- Server: Primary (dropdown menu)
- Key: 3ec3-qhu3-bp5f-2br1-11wj (text input field)
- Passphrase: pp-e000-3ec3-0369-2b19 (text input field)
- Quality: Streaming Medium (dropdown menu)
- Two buttons at the bottom: "OFF" and "ON AIR".

Wklej hasło w polu **Passphrase** narzędzia konfiguracyjnego

Doświadczeni technicznie nadawcy mogą zmienić w pliku XML zarówno protokół RTMP lub SRT, jak i kodek H.264 lub H.265, aby dostosować ustawienia przesyłania strumieniowego do własnych potrzeb. Więcej informacji można znaleźć w sekcji „Blackmagic Streaming XLM Format”.

Panel przedni Web Presentera

Użyj elementów sterujących na panelu przednim urządzenia Blackmagic Web Presenter, aby rozpocząć i zatrzymać transmisję oraz zmienić ustawienia.

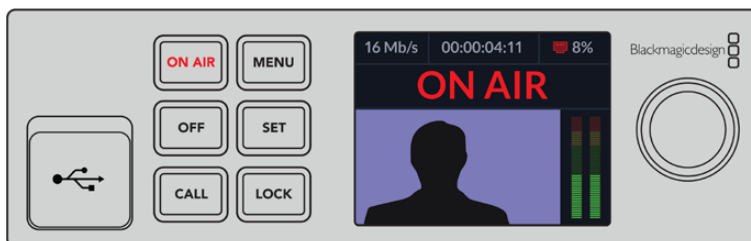

On Air – Aby rozpocząć, wystarczy nacisnąć przycisk **ON AIR**. Podczas transmisji przycisk będzie podświetlony na czerwono.



Jeśli przycisk **ON AIR** miga, oznacza to, że transmisja na żywo nie została rozpoczęta lub została nieoczekiwanie zatrzymana. Może to być spowodowane problemem z połączeniem internetowym lub ustawieniami transmisji strumieniowej. Sprawdź, czy działa połączenie internetowe i czy ustawienia transmisji są prawidłowe.

Off – Aby zatrzymać transmisję, należy nacisnąć przycisk **OFF**.

Menu – Naciśnij przycisk **MENU**, aby otworzyć ustawienia na ekranie LCD.

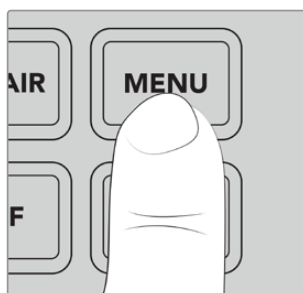

Aby zmienić ustawienie:

- 1 Obróć pokrętkę, aby wybrać ustawienie, które ma zostać zmienione, a następnie naciśnij przycisk **SET**.

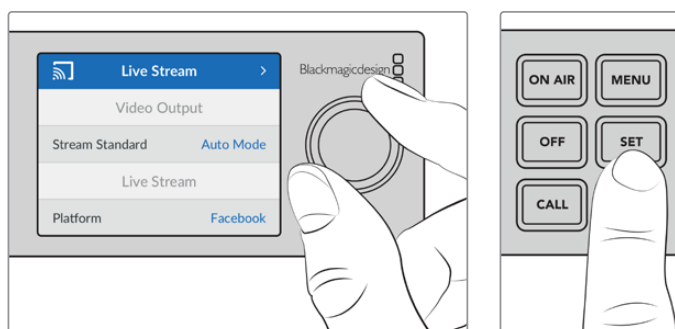

- 2 Obróć pokrętkę, aby zmienić ustawienie.
- 3 Naciśnij **SET** ponownie, aby potwierdzić zmianę.

Naciśnij przycisk **MENU**, aby cofnąć się pomiędzy pozycjami menu i powrócić do ekranu głównego.

Call – Ta funkcja zostanie włączona podczas przyszłej aktualizacji.

Lock – Naciśnij i przytrzymaj ten przycisk przez 1 sekundę, aby zablokować panel. Wyłącza to przyciski, uniemożliwiając przypadkowe wejście na antenę lub zatrzymanie transmisji. Przycisk świeci się na czerwono, jeśli jest aktywny.

Naciśnij i przytrzymaj przycisk przez 2 sekundy, aby odblokować panel.

Wyświetlacz LCD

Ekran główny to pierwszy element widoczny po uruchomieniu Web Presentera. Na ekranie głównym są wyświetlane ważne informacje, w tym:

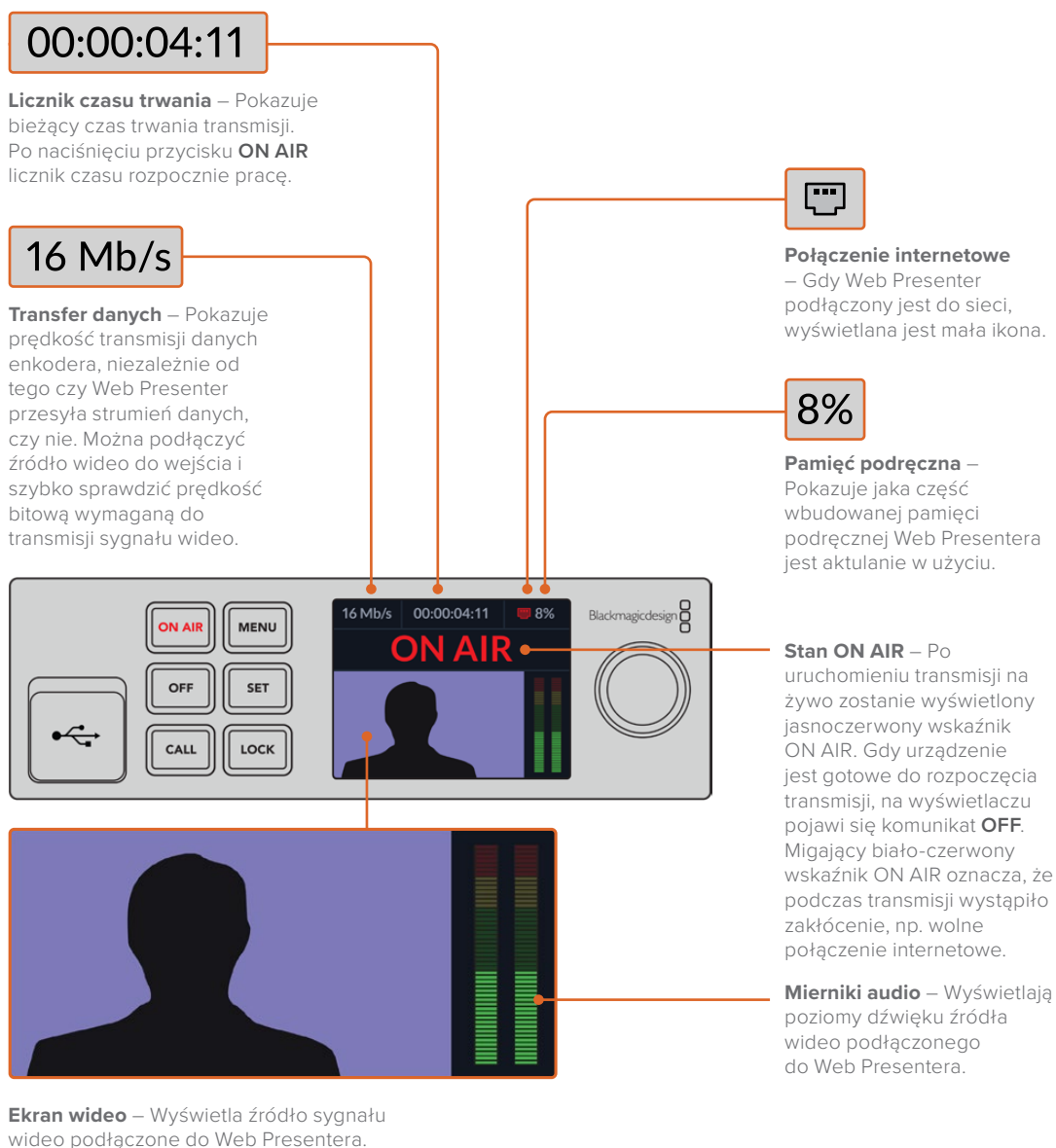

Ikony połączenia internetowego



Niebieska ikona sieci Ethernet jest wyświetlana, gdy podłączony jest kabel Ethernet i do transmisji będzie używane połączenie Ethernet.



Czerwona ikona sieci Ethernet jest wyświetlana podczas nadawania i transmisji strumieniowej przez sieć Ethernet.



Niebieska ikona smartfonu jest wyświetlana, gdy do transmisji będzie używane połączenie internetowe podłączonego smartfonu.



Czerwona ikona smartfonu jest wyświetlana podczas transmisji przez podłączony smartfon.

WSKAZÓWKA Jeśli nie jest wyświetlana żadna ikona, oznacza to, że Web Presenter nie jest podłączony do sieci.

Wyjście monitora

Wyjście monitora umożliwia monitorowanie sygnału wejściowego wideo, poziomów dźwięku, stanu ON AIR, prędkości transmisji danych i poziomów pamięci podręcznej oraz informacje techniczne dotyczące wejścia SDI.



Wyjście monitora urządzenia Blackmagic Web Presenter dostarcza wyczerpujących informacji, w tym o prędkości transmisji danych i stanie pamięci podręcznej

Wyświetlacz wyjścia monitora składa się z 8 paneli. Poniżej znajduje się opis każdego panelu i informacji, które są wyświetlane.

Widok wejścia

Na panelu głównym wyświetlane jest bieżące wejście wideo z podłączonego źródła wideo SDI.



Stan On Air

Przed transmisją wskaźnik stanu gotowości wyświetla komunikat **OFF**, informując, że Web Presenter jest gotowy do transmisji. Po rozpoczęciu nadawania wskaźnik będzie wyświetlał jasnoczerwony stan **ON AIR** do momentu zatrzymania transmisji strumieniowej.



Pod wskaźnikiem **ON AIR** znajduje się licznik czasu trwania. Po naciśnięciu przycisku **ON AIR** na urządzeniu Web Presenter licznik czasu trwania rozpocznie pracę.

Jeśli Web Presenter nie jest na antenie, ale przesyła strumień przez podłączony smartfon, wskaźnik **OFF** zawiera niebieską ikonę smartfonu w rogu. Przycisk świeci się na czerwono, jeśli jest na antenie.

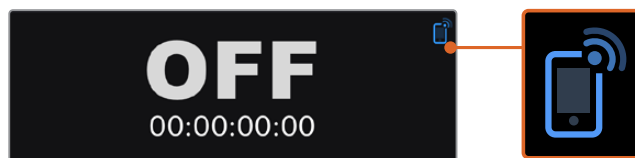

Transmisja na żywo

Panel transmisji na żywo wyświetla informacje o ustawieniach transmisji. Obejmuje to platformę streamingową, serwer i protokół. Wyświetlane są także ustawienia rozdzielczości i jakości transmisji.

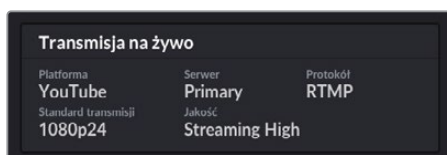

Wejście wideo

5 miniaturowych okien podglądu w górnej części panelu wejściowego wideo pokazuje poprzednie 6 sekund strumienia na żywo, przy czym każde okno podglądu odpowiada 1,2 sekundy czasu transmisji.

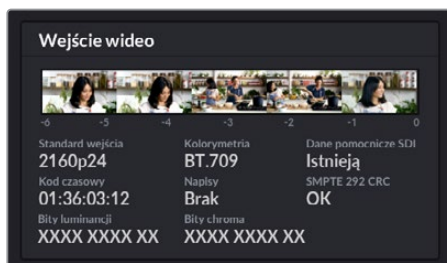

Poniżej okien podglądu można wyświetlić szczegółowe informacje techniczne dotyczące źródła sygnału wideo podłączonego do wejścia SDI Web Presentera.

Standard wejścia	Wyświetla rozdzielczość i klatkaż dla wejścia wideo SDI. Web Presenter obsługuje do 2160p60.
Kolorymetria	Wyświetla przestrzeń kolorów wejścia wideo SDI. Web Presenter obsługuje przestrzenie kolorów Rec.601, Rec.709 i Rec.2020.
Dane pomocnicze SDI	Dane pomocnicze to dane przesyłane na wejściu wideo SDI, które stanowią dodatek do sygnału wideo. Zawierają wbudowane audio, kod czasowy i napisy. Jeśli wejście SDI zawiera dane pomocnicze, wyświetlane będzie Istnieją.
Kod czasowy	Wyświetla kod czasowy ze źródła wejścia wideo SDI.
Napisy	Jeśli wejście wideo SDI zawiera napisy, ich format zostanie wyświetlony w tym miejscu. Obsługuje formaty CEA-608 i CEA-708.
SMPTE 292 CRC	Jest to funkcja sprawdzania błędów dla sygnału wideo SDI. Jeśli Web Presenter wykryje problem z wejściem wideo SDI, wyświetli błąd. Błędy CRC są zwykle spowodowane uszkodzonym kablem SDI lub zbyt długim kablem.
Bity luminacji Yi bity chroma	<p>Wskaźniki „bity luminacji Y” i „bity chroma” informują o aktywności sygnału wejściowego wideo SDI. Każda litera reprezentuje stan jednego bitu sygnału wideo.</p> <p>X – Znak X oznacza stale zmieniający się bit.</p> <p>L – Niski bit.</p> <p>H – Wysoki bit.</p> <p>Aby ułatwić orientację, odejmuje się wartość offsetów SDI. Na przykład wszystkie bity są w stanie niskim, gdy obraz jest czarny.</p> <p>Na wszystkich 10 bitach wejścia wideo SDI pojawi się znak X, co oznacza, że wszystkie bity w strumieniu wideo ulegają ciągłym zmianom. Jeśli wejście SDI to 8-bitowy sygnał wideo, dwa bity usytuowane najbardziej w prawo zawsze będą miały wartość L, ponieważ nie zawierają żadnych danych. Jeśli bit pozostaje jako L lub H, podczas gdy oczekuje się, że będzie to X, oznacza to „zablokowany bit” i może być wynikiem błędu w strumieniu sygnału wideo.</p>

Wejście audio

Na wyświetlaczu kształtu fali dźwiękowej w górnej części panelu wejścia audio wyświetlane są informacje o dźwięku z ostatnich 6 sekund transmisji na żywo.

Są one stale aktualizowane i przewijane od prawej do lewej strony.

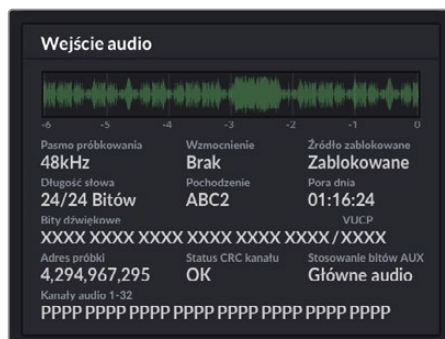

Pod wykresem fali dźwiękowej znajdują się szczegółowe informacje techniczne dotyczące wejścia audio.

Częstotliwość próbkowania	Wyświetla częstotliwość próbkowania dźwięku wbudowanego w wejście SDI.
Wzmocnienie	Wskazuje, czy źródło dźwięku ma włączoną opcję wzmocnienia.
Blokada źródła dźwięku	Wskazuje, czy częstotliwość źródła dźwięku jest zablokowana względem zewnętrznego źródła odniesienia.
Długość słowa	Pokazuje głębię bitową dźwięku wbudowanego w wejście SDI.
Pochodzenie	Te cztery znaki wskazują pochodzenie kanału.
Pora dnia	Swobodnie działający kod czasowy.
Bity dźwiękowe	Pokazuje aktywność bitową w próbkach audio wbudowanych w złącze SDI. Nawet jeśli stan kanału audio wskazuje 16-, 20- lub 24-bitowy dźwięk, aktywność bitowa audio to potwierdzi.
VUCP	Odczytywanie bitów VUCP od lewej do prawej: bit V oznacza „ważny”, U jest bitem „użytkownika”, C jest bitem „stanu kanału”, a P oznacza „parzystość”. To pole jest podobne do pola „bity audio”.
Adres próbki	Licznik próbek dźwięku.
Stosowanie bitów AUX	Wskazuje, czy bity AUX są używane do głównego dźwięku.
Kanały audio 1-32	Każda cyfra reprezentuje kanał audio wbudowany w wejście SDI. Znak P oznacza, że kanał audio jest używany, a znak - oznacza, że na tym kanale nie ma dźwięku.

Wskaźnik prędkości transmisji danych

Na wyświetlaczu prędkości transmisji danych pokazywana jest bieżąca prędkość transmisji danych kodera w ciągu ostatnich 60 sekund. Prędkość transmisji danych jest podawana w megabitach na sekundę. Ten wskaźnik działa stale, nawet gdy nie jest na antenie, co pozwala dokładnie zmierzyć przepustowość przed wejściem na antenę.

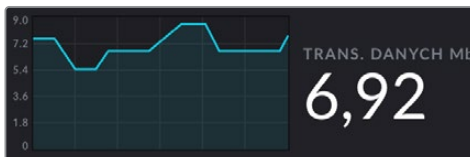

Wskaźnik pamięci podręcznej

Na wyświetlaczu pamięci podręcznej wyświetlany jest procent aktualnie używanego bufora pamięci wbudowanego w Web Presenter, a na wykresie – ilość pamięci używanej w ciągu ostatnich 60 sekund. Pamięć podręczna (cache) to niewielka ilość pamięci wewnętrznej, która w sposób ciągły zapisuje i odtwarza dane wyjściowe programu. Działa jako zabezpieczenie na wypadek, gdyby szybkość transmisji danych spadła poniżej poziomu umożliwiającego utrzymanie wideo.

Wahania połączeń internetowych są spowodowane przede wszystkim obciążeniem sieci lub siłą sygnału bezprzewodowego. Wraz ze spadkiem prędkości przesyłu danych wzrasta ilość danych buforowanych. Jeśli prędkość spada poniżej prędkości wymaganej dla strumienia wideo, pamięć podręczna kompensuje to wypełnianiem ramek wideo. Jednakże, gdy pamięć podręczna jest wypełniona do 100%, zmniejsza się jakość strumienia wideo. W miarę możliwości należy więc unikać wypełnienia pamięci podręcznej. Można przeprowadzić test, podłączając kanał wideo i obserwując wyświetlanie pamięci podręcznej na wyjściu monitora bez konieczności rozpoczynania transmisji. Jeśli pamięć podręczna często dochodzi do 100%, wybierz niższą jakość w ustawieniach transmisji na żywo.



Mierniki audio

Poziomy źródła dźwięku można monitorować za pomocą mierników audio. W ustawieniach menu Web Presentera można ustawić wyświetlanie poziomów PPM lub VU. Jeśli poziom dźwięku jest zbyt wysoki, mierniki będą świecić na czerwono. Może to oznaczać, że dźwięk w strumieniu na żywo może być zniekształcony lub przycięty. Idealnie byłoby, gdyby dźwięk znajdował się w górnej części sekcji zielonej, a od czasu do czasu w części żółtej.

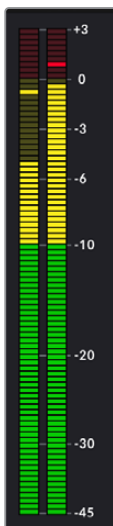

Konfiguracja Web Presentera

Gdy urządzenie Blackmagic Web Presenter jest podłączone do sieci, każdy komputer podłączony do tej samej sieci może być użyty do zdalnego sterowania Web Presenterem. Za pomocą Blackmagic Web Presenter Setup można uzyskać dostęp do tych samych elementów sterujących i ustawień, które są dostępne na panelu przednim urządzenia.

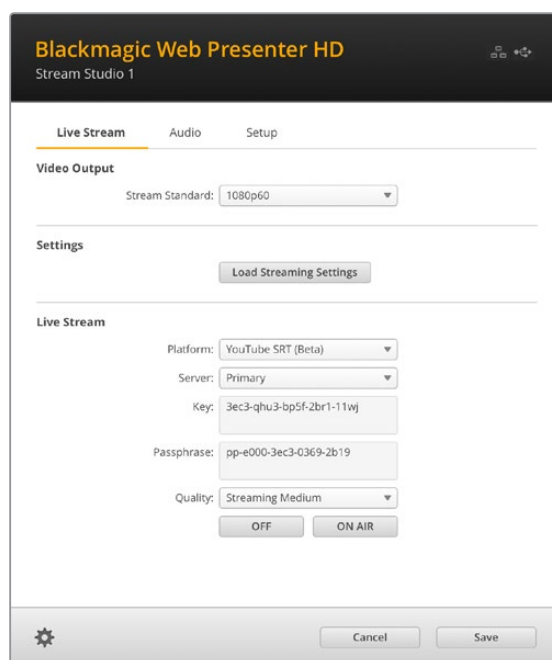
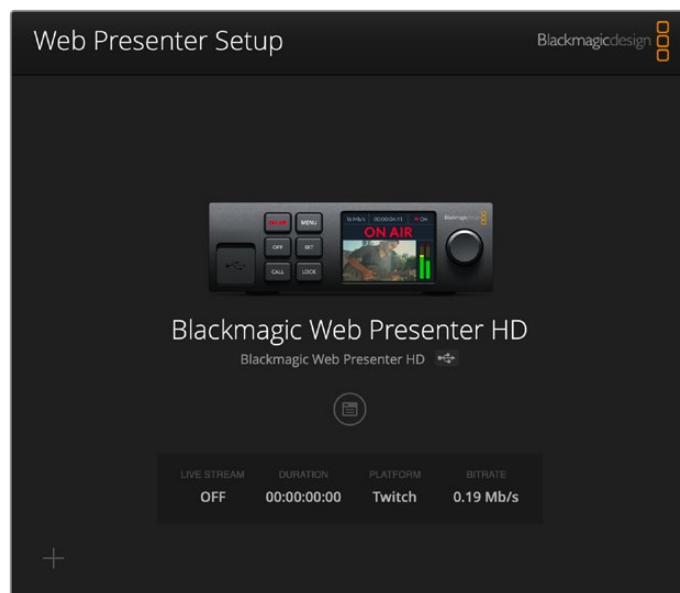

Zakładka transmisji na żywo

Wyjście wideo

Standard transmisji

Kliknij menu **Standard transmisji**, aby wybrać ustawienie rozdzielczości wideo dla strumienia. Do wyboru są rozdzielczości od 720p25 do 1080p60 lub 2160p60, w zależności od używanego modelu Web Presentera.

Ustawienia

Jeśli masz niestandardowe ustawienia przesyłania strumieniowego, na przykład plik XML z Blackmagic ATEM Streaming Bridge, możesz je zaimportować, klikając przycisk „Załaduj ustawienia transmisji”.

Więcej informacji na temat tworzenia ustawień niestandardowych i łączenia się z ATEM Streaming Bridge można znaleźć w części „Tworzenie linków wideo z ATEM Streaming Bridge” w dalszej części niniejszej instrukcji.

Transmisja na żywo

Platforma

Kliknij w menu **Platform** i wybierz platformę streamingową dla swojej transmisji. Dostępne opcje to Facebook, YouTube i Twitch. Jeśli zaimportowałeś niestandardowe ustawienia transmisji, zostaną one również wyświetlone na liście platform.

Aby przesyłać strumieniowo do niestandardowego adresu URL, wybierz opcję niestandardowego adresu URL z menu **Platform**. W Web Presenter 4K można wybrać transmisję do niestandardowego adresu URL przy użyciu H.264 lub H.265, a w Web Presenter HD można strumieniować do niestandardowego adresu URL przy użyciu H.264.

Serwer

Wybierz serwer znajdujący się najbliżej Twojej lokalizacji, zaznaczając go na liście. Lista serwerów będzie się różnić w zależności od wybranej platformy streamingowej.

Jeśli transmitujesz na Instagram, Microsoft Teams lub niestandardowy adres URL, lista serwerów będzie polem edytowalnym. Wprowadź adres URL przypisany z konta platformy streamingowej lub niestandardowe dane adresu URL.

Klucz

Wprowadź klucz transmisji, który został przypisany do Twojej transmisji z platformy streamingowej.

Hasło

Jeśli korzystasz z usługi transmisji z protokołem transmisji strumieniowej SRT, wprowadź hasło przypisane z konta platformy streamingowej.

Jakość

Wybierz jakość transmisji strumieniowej HD lub 4K, zależnie od używanego modelu Web Presentera.

H.264	
HD	4K
HyperDeck wysoka 45 do 70 Mb/s	HyperDeck wysoka 95 do 220 Mb/s
HyperDeck średnia 25 do 45 Mb/s	HyperDeck średnia 66 do 150 Mb/s
HyperDeck niska 12 do 20 Mb/s	HyperDeck niska 38 do 80 Mb/s
Transmisja wysoka 6 do 9 Mb/s	Transmisja wysoka 34 do 51 Mb/s
Transmisja średnia 4,5 do 7 Mb/s	Transmisja średnia 23 do 35 Mb/s
Transmisja niska 3 do 4,5 Mb/s	Transmisja niska 13 do 20 Mb/s

H.265	
HD	4K
Transmisja wysoka 2,3 do 4,5 Mb/s	Transmisja wysoka 22,5 do 30 Mb/s
Transmisja średnia 1,5 do 3 Mb/s	Transmisja średnia 14 do 20 Mb/s
Transmisja niska 0,8 do 2 Mb/s	Transmisja niska 8 do 10 Mb/s

Prędkość transmisji danych używana przez ustawienie jakości zmienia się w zależności od standardu wideo, w jakim pracuje Web Presenter. Na przykład, jeśli wybierzesz wysoką jakość transmisji strumieniowej **Transmisja wysoka** w rozdzielczości 1080p24, prędkość transmisji danych wyniesie 6 Mb/s.

Jak widać w tabeli, prędkość transmisji strumieniowej jest niższa w porównaniu z prędkością transmisji HyperDeck. Umożliwia to przesyłanie danych przez internet, który zazwyczaj wykorzystuje mniejszą szerokość pasma w porównaniu z zapisem danych na dysku.

Warto zauważyć, że przy każdym ustawieniu wymienione są dwie prędkości przesyłu danych. Niższa liczba jest używana w przypadku niższego klatkażu: 24p, 25p i 30p, natomiast wyższa liczba danych jest używana w przypadku wyższego klatkażu: 50p i 60p. Warto również zauważyć, że domyślnym ustawieniem jakości transmisji strumieniowej jest „Wysoka”, ponieważ zapewnia ona bardzo wysoką jakość kanału strumieniowego.

Przyciski OFF i ON AIR

Transmisję na żywo można rozpocząć lub zatrzymać za pomocą przycisków **OFF** i **ON AIR**. Przycisk **ON AIR** świeci się na czerwono, gdy trwa transmisja na żywo.

Usuwanie zaimportowanych ustawień

Aby usunąć wszystkie zaimportowane ustawienia transmisji strumieniowej z programu Web Presenter, kliknij ikonę koła zębatego w lewym dolnym rogu zakładki **Live Stream**. Aby potwierdzić swój wybór, kliknij **Remove**.

Zakładka Audio

Zakładka Audio zawiera opcje pozwalające na konfigurację wyjścia monitorowania dźwięku i mierników audio urządzenia Web Presenter.

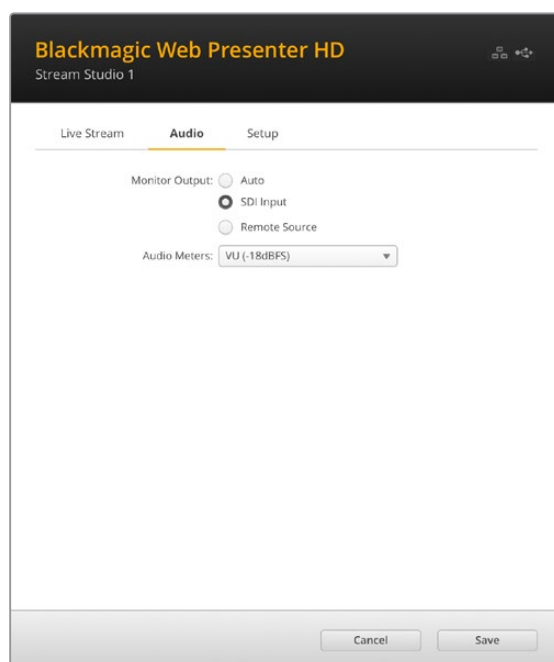

Wyjście monitorowe

Użyj opcji wyjścia monitora, aby wybrać źródło dźwięku używane dla wyjść monitorujących SDI i HDMI urządzenia Web Presenter.

Auto

Gdy wyjście monitora jest ustawione na **Auto**, Web Presenter automatycznie wykryje i będzie monitorować dźwięk talkback wysyłany z miksera ATEM przez ATEM Streaming Bridge. Jeśli talkback nie zostanie wykryty, użyty zostanie dźwięk z wejścia SDI.

Wejście SDI

Wybierz **SDI Input**, aby monitorować dźwięk ze źródła wejściowego SDI urządzenia Web Presenter, na przykład podłączonej kamery Blackmagic Studio.

Zdalne źródło

Ta opcja służy do monitorowania dźwięku talkback wysyłanego ze zdalnego miksera ATEM lub ATEM Streaming Bridge.

Mierniki audio

Wybierz typ miernika audio do wyświetlenia za pomocą menu mierników audio. Dostępne opcje to poziomy odniesienia VU -18dBFS, VU -20dBFS, PPM -18dBFS lub PPM -20dBFS.

Zakładka konfiguracji

The screenshot displays the configuration page for a Blackmagic Web Presenter HD. At the top, the title is "Blackmagic Web Presenter HD" with "Stream Studio 1" below it. There are three tabs: "Live Stream", "Audio", and "Setup", with "Setup" being the active tab. The "Setup" section contains the following fields:

- Name: Stream Studio 1
- Language: English (dropdown menu)
- Software: Version 3.3

The "Network" section includes:

- Protocol: Radio buttons for DHCP and Static IP (Static IP is selected).
- IP Address: 192.168.24.100
- Subnet Mask: 255.255.255.0
- Gateway: 192.168.24.1
- Primary DNS: 8.8.8.8
- Secondary DNS: 8.8.4.4
- Connection Priority: Radio buttons for Ethernet and Mobile (Mobile is selected).

Below the network settings is a "Reset" section with a "Factory Reset" button. At the bottom right of the interface are "Cancel" and "Save" buttons.

Nazwa

Jeśli chcesz zmienić nazwę swojego Web Presentera, wpisz nową nazwę w polu i kliknij przycisk **Zapisz**.

Język

Umożliwia zmianę ustawień języka urządzenia.

Oprogramowanie

Wyświetla bieżącą wersję oprogramowania Web Presenter.

Sieć

Te ustawienia umożliwiają skonfigurowanie takich opcji, jak wybór między łączeniem się z siecią za pomocą protokołu DHCP a używaniem statycznego adresu IP. Więcej informacji na temat podłączania urządzenia Web Presenter do sieci można znaleźć w rozdziale „Ustawienia sieci”.

Priorytet połączenia – Jeśli do Web Presentera jest podłączona zarówno sieć Ethernet, jak i telefon komórkowy, to ustawienie umożliwia wybranie połączenia, które będzie używane do transmisji strumieniowej. Więcej informacji na temat mobilnego tetheringu można znaleźć w sekcji „Transmisja za pomocą smartfonu”.

Resetowanie

Zresetuj Web Presenter, klikając przycisk **Przywracanie ustawień fabrycznych**.

Ustawienia sieci

Web Presenter może połączyć się z siecią przy użyciu statycznego adresu IP lub za pomocą protokołu DHCP.

DHCP – automatycznie ustawi adres IP dla urządzenia i podłączy je do sieci bez konieczności zmiany jakichkolwiek ustawień.

Protokół dynamicznej konfiguracji, w skrócie DHCP, jest usługą na serwerach sieciowych i routerach, która automatycznie wyszukuje urządzenie Web Presenter i przypisuje mu adres IP. DHCP ułatwia podłączenie urządzeń przez Ethernet i dba, aby ich adresy IP nie kolidowały ze sobą. Większość komputerów i przełączników sieciowych obsługuje DHCP.

Statyczne IP – Jeśli adres IP ma być ustawiony przez użytkownika samodzielnie, wystarczy w ustawieniach protokołu wybrać opcję **Statyczne IP** i ręcznie zmienić ustawienia IP.

Statyczny adres IP to taki, który nie ulegnie zmianie nawet po ponownym uruchomieniu Web Presentera.

Użycie statycznego adresu IP może być konieczne w przypadku podłączenia Web Presentera do sieci firmowej. Jeśli masz administratora sieci, możliwe jest, że Twoja sieć może mieć niestandardowe adresy IP dla wszystkich podłączonych do niej urządzeń. Najlepiej jest sprawdzić to u administratora sieci, który zarządza komputerami i siecią w firmie.

Ustawianie udostępniania internetu dla bezpośredniej transmisji

Jeśli nie możesz podłączyć Web Presentera bezpośrednio do przełącznika sieciowego lub routera internetowego, możesz udostępnić połączenie internetowe komputera z Web Presenterem przez port Ethernet.

Aby skonfigurować Blackmagic Web Presenter dla bezpośredniej transmisji:

- 1 Ustaw Web Presenter na DHCP.
- 2 Skonfiguruj komputer tak, aby udostępniał połączenie internetowe przez port Ethernet.

Mac: w **Preferencje systemowe** kliknij **Udostępnij** i wybierz **Udostępnij internet** z listy **Usługi**. W menu **Udostępnij swoje połączenie z**, wybierz **Wi-Fi** jeśli Twój Mac jest podłączony do internetu przez Wi-Fi. Z listy **Do komputerów używających**, wybierz **Ethernet**. Z listy **Usługi**, zaznacz pole **Udostępnij internet**. Gdy zostaniesz zapytany, czy na pewno chcesz uruchomić udostępnienie internetu, kliknij **Start**.

Windows: Kliknij prawym przyciskiem myszy ikonę **Start** i wybierz **Połączenia sieciowe**. Pojawi się ekran **Stan sieci**. Kliknij przycisk **Zmień opcje adaptera**. Zostanie wyświetlona lista połączeń sieciowych komputera. Kliknij prawym przyciskiem myszy na połączenie internetowe i wybierz **Właściwości**. W zakładce **Udostępnij** zaznacz **Zezwalaj innym użytkownikom sieci na łączenie się poprzez połączenie internetowe tego komputera**. Wybierz połączenie sieciowe w menu i kliknij **OK**.

- 3 Podłącz Web Presenter do portu Ethernet na swoim komputerze. Po kilku sekundach protokół DHCP przypisze adres IP do Web Presentera.
- 4 Sprawdź, czy Web Presenter jest podłączony do internetu przez sieć Ethernet, obserwując ikonę sieci Ethernet w prawym górnym rogu ekranu LCD urządzenia.

Transmisja za pomocą smartfonu

Blackmagic Web Presenter umożliwia transmisję przez połączenie tetheringowe ze smartfonem, czyli z dowolnego miejsca, gdzie smartfon ma połączenie komórkowe.

Aby skonfigurować mobilny tethering:

- 1 Podłącz swój smartfon do Blackmagic Web Presentera za pomocą kabla USB typu C. Złącza USB typu C można używać na przednim lub tylnym panelu.
- 2 Włącz w smartfonie funkcję hotspotu internetowego.

Na urządzeniu z systemem iOS otwórz **Ustawienia** > **Osobisty hotspot** i upewnij się, że opcja **Zezwalaj innym na dołączenie** jest włączona. Na urządzeniu Android przesunij palcem po ekranie, aby wyświetlić szybkie menu. Naciśnij i przytrzymaj ikonę hotspotu, a następnie włącz tethering USB.

Teraz możesz nacisnąć przycisk **ON AIR** na urządzeniu Blackmagic Web Presenter, aby rozpocząć transmisję na żywo.

WSKAZÓWKA Kiedy zakończysz transmisję, zalecamy wyłączenie połączeń tetheringowych w celu oszczędzenia baterii.

Jeśli do Web Presentera podłączono kabel Ethernet, zaleca się sprawdzenie, czy jest ono skonfigurowane do korzystania z funkcji tetheringu przez internet mobilny. Otwórz oprogramowanie użytkowe Web Presenter Setup i przejdź do zakładki **Konfiguracja**. W sekcji **Sieć** ustaw priorytet połączenia na **Mobilne**.

Blackmagic Web Presenter jako kamera internetowa

Programy takie jak Skype czy Zoom powinny automatycznie ustawić Web Presentera jako kamerkę internetową, więc po uruchomieniu aplikacji natychmiast zobaczysz obraz z Web Presentera. Jeśli aplikacja nie wybierze automatycznie programu Web Presenter, ustaw go ręcznie tak, aby korzystać z Web Presentera tak jak z kamerki internetowej i mikrofonu.

Poniżej znajduje się przykład, jak skonfigurować ustawienia kamerki internetowej na Skypie.

- 1 Na pasku menu Skype'a otwórz **Ustawienia wideo i audio**.
- 2 Naciśnij na menu **Kamera** i wybierz Web Presenter z listy. Zobaczysz wideo z Web Presentera w oknie podglądu.
- 3 Teraz przejdź do menu **Mikrofon** i wybierz Web Presenter jako źródło audio.

Konfiguracja Open Broadcastera

Open Broadcaster to aplikacja typu open source, działająca jak platforma streamingowa pomiędzy Web Presenter a Twoim ulubionym oprogramowaniem streamingowym, takim jak YouTube, Twitch, Facebook Live i inne. Open Broadcaster kompresuje wideo do prędkości bitowej, którą można łatwo zarządzać przez aplikację streamingową.

Poniższy przykład pokazuje, jak skonfigurować Open Broadcastera do transmitowania wyjścia kamery internetowej z Web Presentera, używając YouTube jako usługi streamingowej.

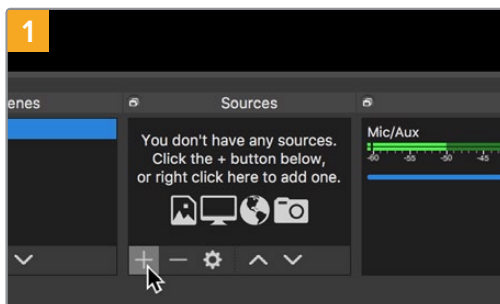

Uruchom Open Broadcaster i kliknij na znak plus w oknie Źródła.

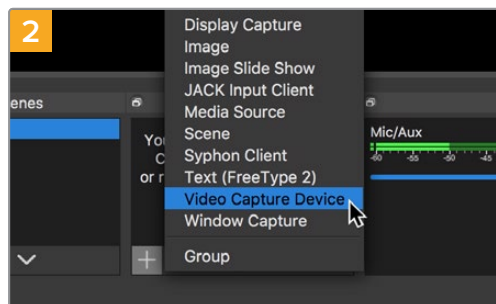

Wybierz Video Capture Device (Urządzenie do przechwytywania wideo).

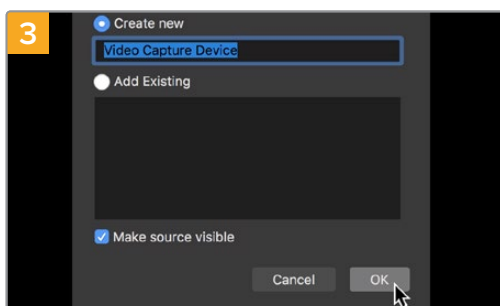

Nazwij nowe źródło i kliknij OK.

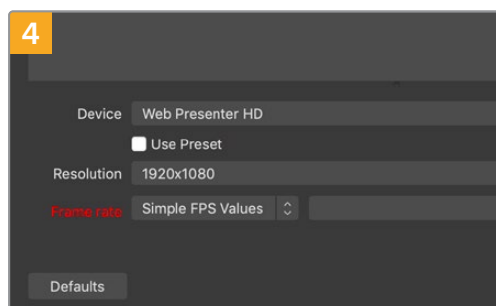

W menu urządzenia wybierz model Web Presenter i kliknij przycisk OK.

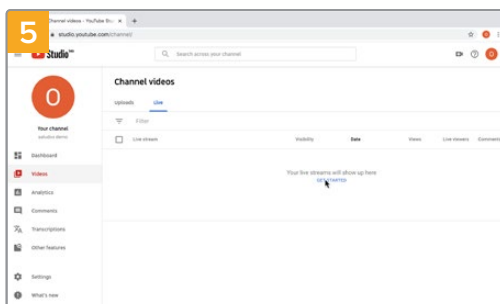

Teraz przejdź na swoje konto w YouTube. Kliknij przycisk Na żywo, a następnie kliknij Transmisja.

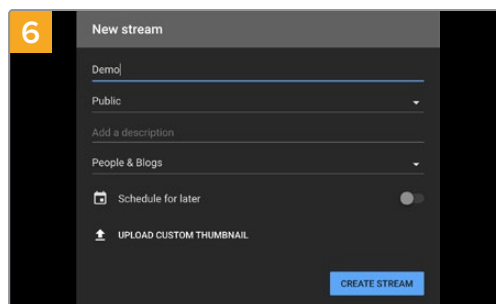

W opcjach YouTube Transmisja wprowadź szczegóły transmisji i kliknij Utwórz transmisję.

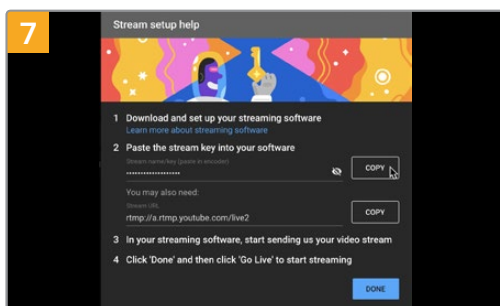

YouTube wygeneruje teraz nazwę strumienia/klucza, który przekieruje Open Broadcaster na Twoje konto YouTube.

Kliknij przycisk Kopiuj obok klucza transmisji. Skopiuj klucz transmisji i wklej go do Open Broadcastera.

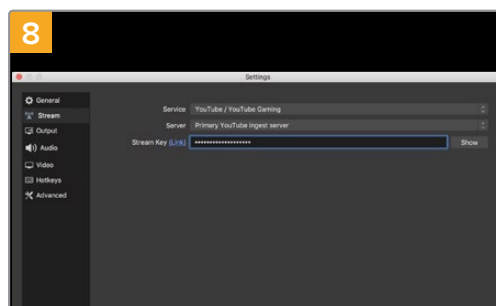

Wróć do Open Broadcastera i otwórz preferencje, klikając na OBS/preferencje na pasku menu. Wybierz Stream (Transmisja). Teraz wklej klucz transmisji skopiowany z YouTube i kliknij OK. Zobaczysz wideo z Web Presentera w oknie podglądu transmisji Open Broadcastera.

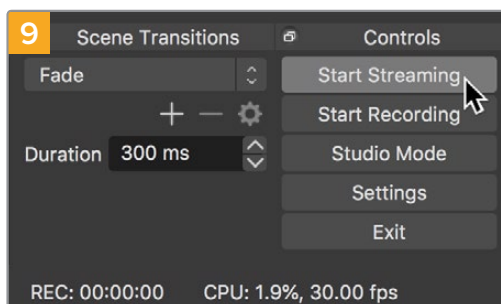

Aby połączyć link do transmisji Open Broadcastera z YouTube, kliknij **Rozpocznij transmisję** w prawym dolnym rogu ekranu. To ustala link do YouTube z Open Broadcasterem i od tego momentu wszystko będzie konfigurowane za pomocą YouTube Live.

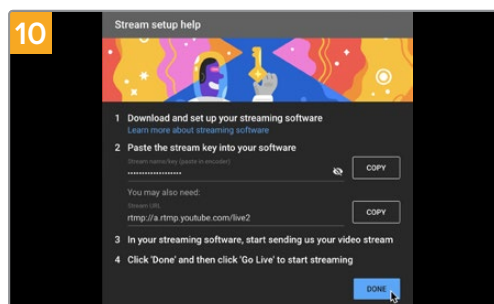

Wróć do YouTube Live, a w tle zobaczysz wyjście programu kamerki internetowej z Twojego Web Presentera. Kliknij **Done** (Gotowe).

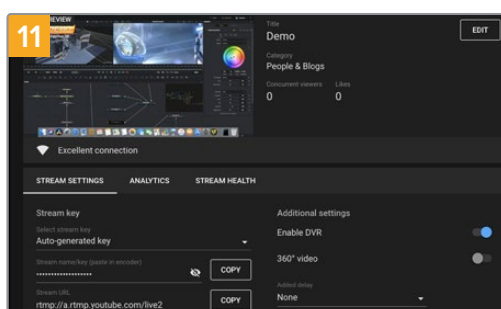

Open Broadcaster komunikuje się teraz z YouTube Live. Wszystko jest gotowe do rozpoczęcia transmisji. Przeprowadź ostateczną kontrolę i sprawdź, czy wszystko działa jak należy.

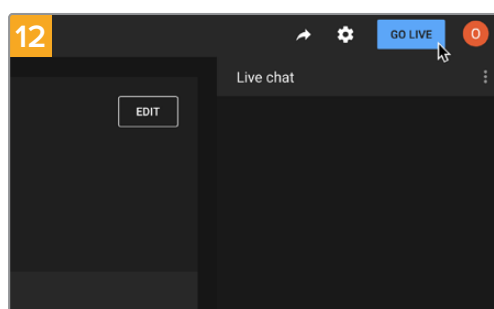

Jeśli wszystko działa, możesz rozpocząć transmisję, klikając **Go live** (Nadawaj na żywo).

Teraz nadajesz na żywo do YouTube za pomocą Open Broadcastera.

UWAGA Częste opóźnienia są charakterystyczne dla transmisji w internecie. Koniecznie obserwuj transmisję na YouTube i upewnij się, że program się zakończył. Dopiero wtedy kliknij przycisk **Zakończ transmisję**. W przeciwnym razie ryzykujesz przedwczesne przerwanie transmisji.

Tworzenie linków wideo z ATEM Streaming Bridge

ATEM Streaming Bridge pozwala na dekodowanie transmisji wideo z Web Presentera i konwertowanie jej z powrotem do wideo SDI lub HDMI. Umożliwia to przesyłanie obrazu wideo przez sieć lokalną lub przez internet do dowolnego miejsca na świecie.

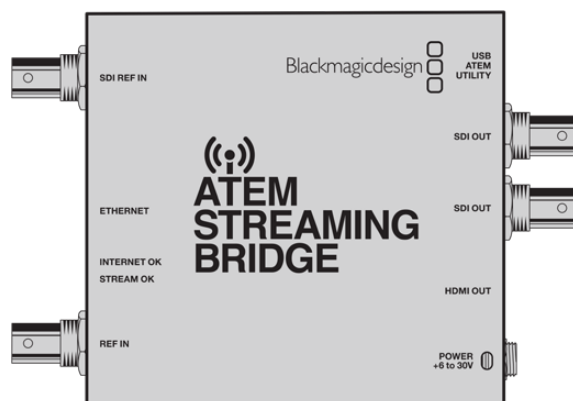

Jeśli ATEM Streaming Bridge jest podłączony do tej samej sieci lokalnej co Web Presenter, będzie on widoczny w menu **Platforma** w zakładce **Transmisja na żywo** w Web Presenter Setup.

Alternatywnie plik XML z ustawieniami transmisji strumieniowej można załadować z nośnika USB podłączonego do Web Presentera lub z komputera za pomocą programu Web Presenter Setup.

Dobrym przykładem współdziałania Blackmagic Web Presenter z ATEM Streaming Bridge jest transmisja raportu pogodowego do studia z odległej lokalizacji. Do transmisji z terenu potrzebny jest tylko program Web Presenter i połączenie z internetem przez np. smartfon lub podłączenie do sieci.

ATEM Streaming Bridge pobiera w studiu sygnał z internetu i konwertuje go na SDI, dzięki czemu można go podłączyć do głównego miksera w studiu.

Dla tego przykładu przepływ pracy będzie wyglądał następująco:

- 1 W terenie Blackmagic Web Presenter jest podłączony do wyjścia Program SDI w mikserze. Na przykład ATEM Constellation 8K.
- 2 Blackmagic Web Presenter jest następnie podłączany do smartfonu.
- 3 W studiu ATEM Streaming Bridge jest również podłączony do internetu za pomocą sieci Ethernet.
- 4 ATEM Streaming Bridge przesyła następnie skonwertowany sygnał wideo SDI z internetu do wejścia SDI miksera studyjnego w celu nadania głównego programu informacyjnego.

Aby studio mogło podłączyć ATEM Streaming Bridge do sygnału internetowego Web Presentera, należy uruchomić narzędzie ATEM Setup i skonfigurować ustawienia internetowe. Obejmuje to wygenerowanie pliku XML zawierającego wszystkie ustawienia transmisji strumieniowej, które są następnie ładowane do Web Presentera w terenie.

Tworzenie pliku XML

Aby utworzyć plik konfiguracyjny XML, podłącz ATEM Streaming Bridge do internetu, podłączając kabel sieciowy z portu Ethernet do routera internetowego lub przełącznika sieciowego.

Podłącz ATEM Streaming Bridge do komputera za pomocą kabla USB typu C i uruchom program ATEM Setup.

W zakładce **Konfiguracja** sprawdź, czy ustawienia sieciowe są prawidłowe i wybierz **Internet** z opcji **Usługa strumieniowa**. W oknie stanu internetu powinien pojawić się komunikat „Widoczny na całym świecie”. To oznacza, że wszystko działa prawidłowo.

Uwaga na temat przekierowania portów

Jeśli w oknie **Stan internetu** wyświetlany jest błąd przekierowania portów lub UPnP, należy poprosić dostawcę Internetu lub administratora sieci o skonfigurowanie przekierowania portów połączenia internetowego na **TCP port 1935**.

Przesyłanie pliku XML

Po potwierdzeniu ustawień w zakładce ATEM Setup i pomyślnym podłączeniu ATEM Streaming Bridge do sieci lub internetu można wyeksportować plik konfiguracyjny XML.

- 1 Kliknij **Zewnętrzny ATEM Mini Pro** w prawej górnej części okna.

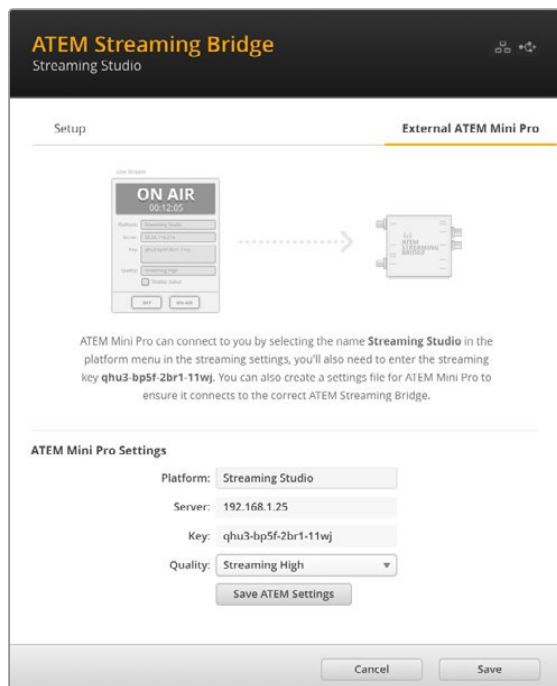

- 2 Aby nadać platformie własną nazwę, kliknij pole **Platforma** i wpisz nową nazwę. Nazwa ta będzie nazwą wyświetlaną w menu platformy zdalnego urządzenia Blackmagic.
- 3 Wybierz pożądaną jakość transmisji. To ustawienie określa ustawienia jakości w zdalnym Web Presenterze.
- 4 Kliknij przycisk **Zapisz ustawienia ATEM**, wybierz miejsce na komputerze, w którym chcesz zapisać plik XML, a następnie kliknij **Zapisz**.
- 5 Zapisany plik XML można teraz wysłać pocztą elektroniczną do operatora w terenie.

WSKAZÓWKA Za pomocą ustawień talkback w ATEM Setup można wybrać kanały audio, które mają być wysyłane do zdalnego Web Presentera.

Przesyłanie pliku XML

Po wysłaniu pliku z ustawieniami do lokalizacji w terenie, tamtejsza ekipa po prostu łączy plik XML do Web Presentera za pomocą Blackmagic Web Presenter Setup, a następnie naciska przycisk **ON AIR**, aby rozpocząć strumieniowe przesyłanie raportu pogodowego do studia!

Należy wspomnieć, że po wczytaniu pliku XML z danymi transmisji można uruchamiać i zatrzymywać transmisję bez konieczności ponownego wczytywania tego pliku. Dzięki temu można łatwo skonfigurować stałe łącze wideo między Web Presenterem a ATEM Streaming Bridge.

Jeśli ATEM Streaming Bridge w studiu nie zmienił ustawień transmisji strumieniowej i ustawień sieciowych, to zawsze znajdzie dany Web Presenter, niezależnie od tego, gdzie znajduje się on w internecie. W dowolnym miejscu można po prostu podłączyć Web Presenter do internetu, nacisnąć przycisk **ON AIR** i natychmiast rozpocząć transmisję do ATEM Streaming Bridge w studiu.

Więcej szczegółów na temat korzystania z ATEM Streaming Bridge można znaleźć w instrukcji obsługi ATEM Mini, która jest dostępna do pobrania na stronie www.blackmagicdesign.com/pl/support

Tally, talkback i sterowanie kamerą

ATEM Streaming Bridge i Blackmagic Web Presenter umożliwiają również mikserom ATEM przesyłanie informacji tally, talkback i sterowania kamerą. Oznacza to, że dowolną kamerą Blackmagic Design opartą na interfejsie SDI można umieścić w dowolnym miejscu sieci lokalnej lub w dowolnym miejscu na świecie za pośrednictwem internetu i nadal korzystać z funkcji tally, talkback oraz sterowania kamerą.

Jego konfiguracja jest bardzo prosta. Poniższa ilustracja przedstawia sposób podłączenia kamery URSA Mini Pro 4.6K do ATEM Constellation 8K za pośrednictwem sieci lokalnej z funkcją tally, talkback i sterowania kamerą.

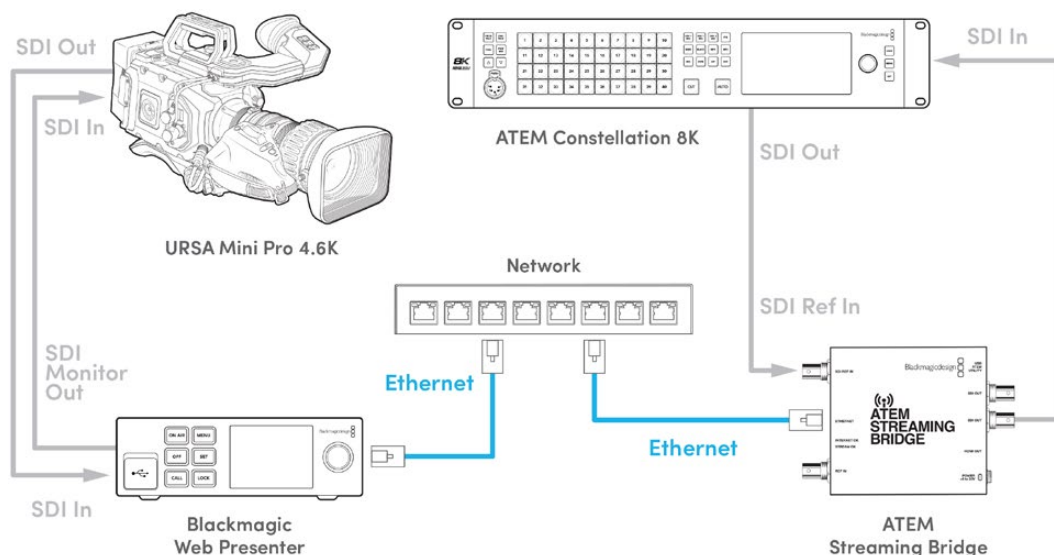

Po podłączeniu wszystkiego:

- 1 Naciśnij przycisk **Menu** na Blackmagic Web Presenter, aby otworzyć menu LCD i przejść do menu **Transmisja na żywo**.
- 2 Wybierz ATEM Streaming Bridge z menu **Platforma**.
- 3 Wciśnij **Ustaw**, aby potwierdzić.

Aby tally działało, musisz się upewnić, że kamera ma ustawiony identyfikator kamery ATEM zgodny z wejściem w mikserze. Informacje na temat sposobu ustawiania identyfikatora kamery ATEM znajdują się w instrukcji obsługi URSA Mini.

Można sprawdzić, czy tally działa, przełączając kamerę na wyjście programowe w mikserze ATEM. Jeśli identyfikator kamery ATEM jest prawidłowo ustawiony w kamerze, zobaczysz, że lampka tally świeci się, a wokół wyświetlacza LCD kamery pojawi się czerwona obwódka tally. Przełącz kamerę na wyjście podglądu, a wskaźnik tally zaświeci się na zielono.

Spróbuj wyregulować przysłonę i poziom referencyjnej czerni na stronie kamery w oprogramowaniu ATEM Software Control, aby przetestować sterowanie kamerą.

Wbudowane kanały audio SDI 15 i 16 są ustawione jako domyślne kanały talkback, ale można je zmienić na kanały inżynierskie 13 i 14 lub wyjście programu za pomocą ATEM Setup Utility.

Podczas transmisji przez internet za pomocą ATEM Setup Utility tworzony jest plik konfiguracyjny XML. Ten plik XML jest następnie ładowany do Blackmagic Web Presentera, dzięki czemu może on rozpoznać ATEM Streaming Bridge w internecie. Więcej informacji na temat tworzenia i wczytywania pliku konfiguracyjnego XML można znaleźć w poprzedniej części niniejszej instrukcji.

Podłączanie URSA Broadcast G2

URSA Broadcast G2 ma wbudowany silnik strumieniowy, dzięki czemu nie trzeba używać Blackmagic Web Presentera, ponieważ kamera może przesyłać strumień bezpośrednio ze swojego portu USB typu C. Więcej informacji na ten temat oraz na temat ustawiania identyfikatora kamery ATEM, aby tally działało prawidłowo, można znaleźć w instrukcji URSA Broadcast G2.

Blackmagic Universal Rack Shelf

Blackmagic Universal Rack Shelf mieści się w jednym racku i umożliwia montaż szerokiej gamy produktów Blackmagic Design w racku nadawczym lub skrzyni transportowej. Modułowa konfiguracja pozwala tworzyć przenośne i praktyczne zestawy sprzętowe przy użyciu kompaktowych produktów, które mieszczą się w jednym racku.

Ilustracja poniżej przedstawia 3 półki Universal Rack Shelf zainstalowane w małym racku z różnymi kompatybilnymi urządzeniami. Dolna półka zawiera panel zaślepiający o szerokości 1/3 racka do wypełniania niewykorzystanych przestrzeni między urządzeniami.

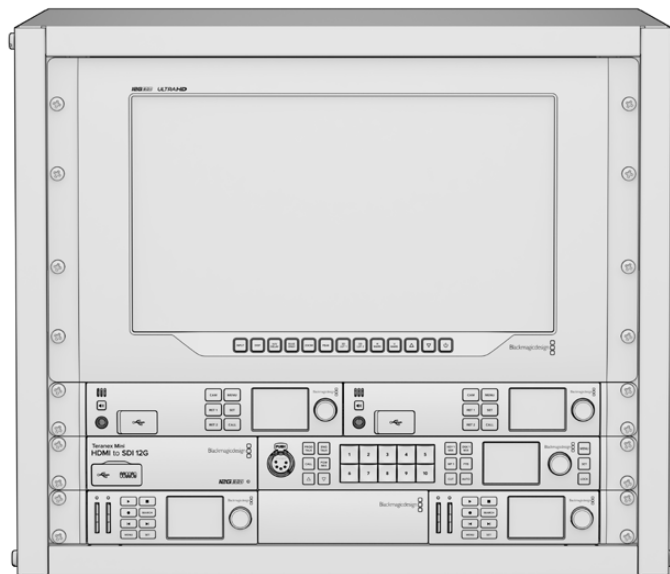

Zawartość

Universal Rack Shelf Kit zawiera następujące elementy:

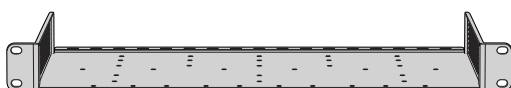

1 x Blackmagic Universal Rack Shelf

Pojedyncza półka do montażu w racku o pełnej szerokości do instalacji sprzętu Blackmagic Design.

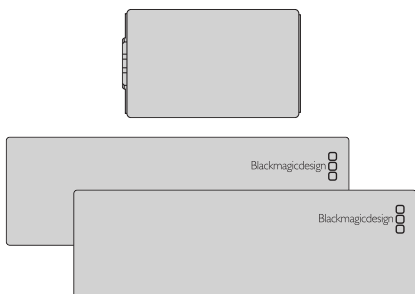

Panele zaślepiające

1 x panel zaślepiający o szerokości 1/6 racka i
2 x panele zaślepiające o szerokości 1/3 racka, by
zakryć niewykorzystaną przestrzeń.

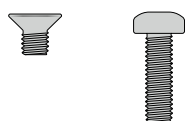

Śruby

12 x M3 5 mm śruby
montażowe z łbem
stożkowym.

2 x M3 9 mm płaskie
śruby do paneli
zaślepiających 1/6.

Montaż urządzenia w racku

- 1 Jeśli dołączone są gumowe nóżki, należy je usunąć z podstawy urządzenia za pomocą narzędzia o plastikowych krawędziach.
- 2 Trzymając rack i urządzenie do góry nogami, wyrównaj wywiercone otwory na racku z gwintowanymi otworami montażowymi na spodzie urządzenia Blackmagic Design. Na urządzeniach o szerokości 1/3 racka znajdują się dwa centralne punkty montażowe, a na większych urządzeniach o szerokości 1/2 racka – do trzech punktów montażowych.

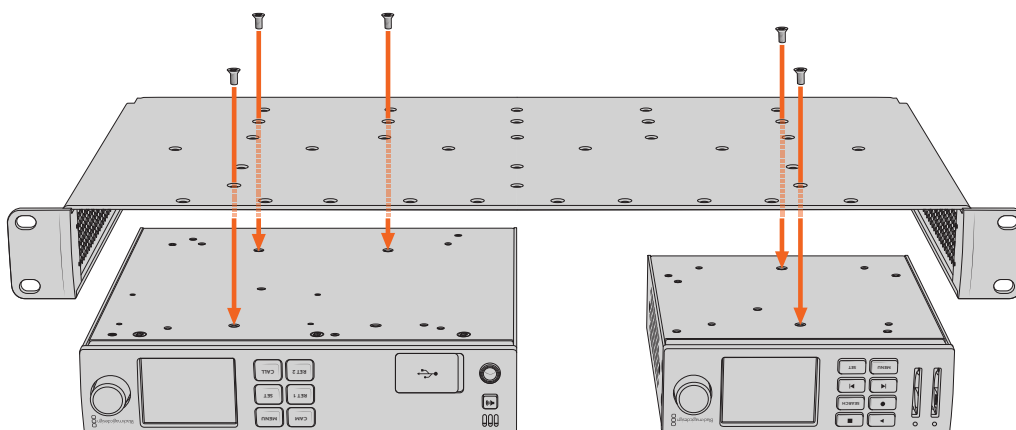

- 3 Używając dostarczonych śrub M3 5 mm z łbem stożkowym, zamontuj urządzenie w racku.
- 4 Po zainstalowaniu obróć półkę rack prawą stroną do góry i zainstaluj w racku za pomocą uchwyty rackowych.

Dostarczone panele zaślepiające można wykorzystać do wypełnienia pustych przestrzeni.

Mocowanie panelu zaślepiającego 1/6

Mały panel zaślepiający 1/6 można wykorzystać do wypełnienia pustej przestrzeni w racku podczas montażu urządzeń o szerokości 1/2 i 1/3 racka. Panel można zamontować z boku urządzenia. Aby przepływ powietrza między urządzeniami był bardziej wydajny, warto zamontować pomiędzy nimi panel.

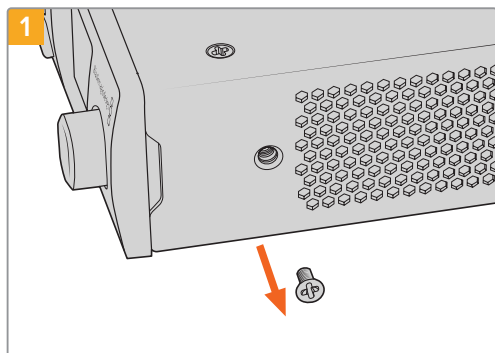

Wykręć śrubę M3 5 mm znajdującą się z przodu urządzenia

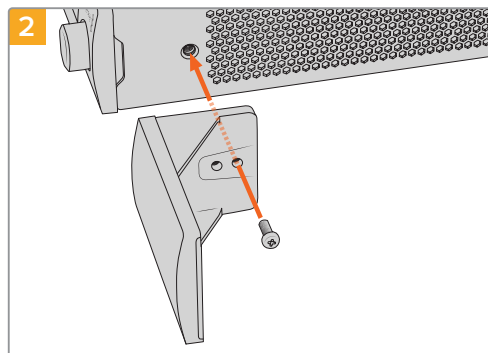

Wyrównaj panel zaślepiający i zamocuj za pomocą dostarczonej śruby nylonowej M3 9 mm

Mocowanie panelu zaślepiającego 1/3

Duże panele zaślepiające o szerokości 1/3 racka można zainstalować po dowolnej stronie półki podczas montażu pojedynczych urządzeń. Aby zamontować panel zaślepiający, należy wyrównać otwory na śruby i punkty mocowania u podstawy panelu z półką i przykręcić za pomocą dwóch dostarczonych śrub M3 5mm z łbem stożkowym.

Aktualizacja oprogramowania wewnętrznego

Narzędzie instalacyjne umożliwia aktualizację oprogramowania wewnętrznego urządzenia Web Presenter oraz konfigurację ustawień i jakości transmisji strumieniowej oraz ustawień sieciowych.

Aby zaktualizować oprogramowanie wewnętrzne:

- 1 Pobierz najnowszy instalator Blackmagic Web Presenter ze strony www.blackmagicdesign.com/pl/support.
- 2 Uruchom instalator Blackmagic Web Presenter i postępuj zgodnie z instrukcjami wyświetlanymi na ekranie.
- 3 Po zakończeniu instalacji podłącz urządzenie Web Presenter do komputera za pomocą złącza USB znajdującego się na panelu tylnym lub na panelu przednim pod plastikową osłoną przeciwpyłową.
- 4 Uruchom Blackmagic Web Presenter Setup i postępuj zgodnie z instrukcjami wyświetlanymi na ekranie, aby zaktualizować oprogramowanie wewnętrzne. Jeśli nie pojawi się żaden komunikat, oznacza to, że oprogramowanie wewnętrzne jest aktualne i nie trzeba nic więcej robić.

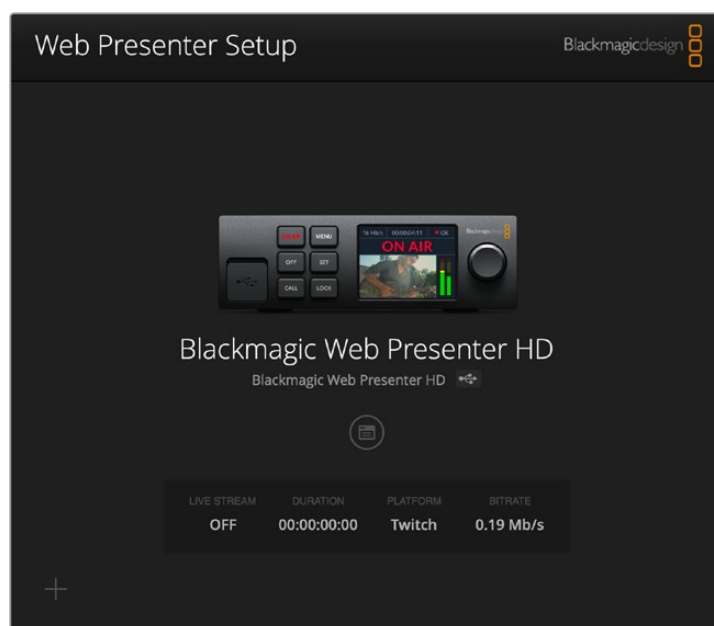

Pobierz najnowszą wersję oprogramowania Blackmagic Web Presenter z centrum wsparcia technicznego Blackmagic Design pod adresem www.blackmagicdesign.com/pl/support

Developer Information

Blackmagic Web Presenter Ethernet Protocol

v1.2

Protocol Details

Overview

The Blackmagic Web Presenter Ethernet Protocol is a line-oriented, text-based protocol to control a Web Presenter.

Lines from the Web Presenter server will be separated by an ASCII LF sequence.

Messages from the user may be separated by LF or CR LF.

Connection

The Web Presenter server is accessed by connecting to TCP port 9977 on a Web Presenter.

Connection Response

Upon connection, the Web Presenter server sends a dump of the device's state.

The Web Presenter server sends information in blocks, with each having an identifying header followed by a colon. A block spans multiple lines and is terminated by a blank line. Each line in the protocol is terminated by a newline character.

Following the header, a block contains either a single multi-line string or a sequence of key/value pairs arranged one per line. The first full-colon on a line is used to delimit the key and the value. A value may be a comma separated list. In this case, values in the list must have the “,” and “\” characters escaped with a “\” character.

To be resilient to future protocol changes, clients should ignore blocks they do not recognize, up to the trailing blank line. Within recognized blocks, clients should ignore keys they do not recognize.

Legend	
↵	End of line
...	and so on
Orange Text	Client Generated
Grey Text	Server Generated

The protocol preamble block is always the first block sent by the Web Presenter server:

```
PROTOCOL PREAMBLE:↵
Version: 1.2↵
↵
```

The version field indicates the protocol version. When the protocol is changed in a compatible way, the minor version number will be updated. If incompatible changes are made, the major version number will be updated.

The initial status dump is concluded by the end prelude block:

```
END PRELUDE:↵
↵
```

Status Updates

When any device parameter is changed on the Web Presenter server by any client, such as the Blackmagic Web Presenter Setup utility, the Web Presenter server resends the applicable status block, containing only the items that have changed. Status updates can also occur due to external changes such as tethering to a smartphone or when a streaming service is disconnected.

For example, if the input video mode is set to Auto, the following block will be sent:

```
STREAM SETTINGS:↵  
Video Mode: Auto↵  
↵
```

Requesting Changes

To change one or more parameters in a block, the client should send the appropriate block header in the same form the Web Presenter server sends, followed by the key/value pairs to be changed. For example, to change the input video format to 1080p59.94, the user should send the following block:

```
STREAM SETTINGS:↵  
Video Mode: 1080p59.94↵  
↵
```

The block must be terminated by a blank line. On receipt of a blank line, the Web Presenter server will either acknowledge the request by responding:

```
ACK↵  
↵
```

or if unable to parse the block responding with:

```
NACK↵  
↵
```

After a positive response, the client should expect to see a status update from the Web Presenter server showing the status change. This is likely to be the same as the command that was sent, sometimes followed by other blocks providing data specific to the change.

```
STREAM SETTINGS:↵  
Video Mode: 1080p59.94↵  
↵
```

If the Web Presenter server does not understand a key in the requested block, the key will be ignored. If an invalid value is provided for a known key, then the request is ignored and the Web Presenter will respond with the existing value for the key. In both cases the Web Presenter server will still respond with an ACK.

```
STREAM SETTINGS:↵  
Video Mode: UnsupportedMode↵  
↵  
ACK↵  
↵  
STREAM SETTINGS:↵  
Video Mode: 1080p59.94↵  
↵
```

Requesting a Status Dump

The user may request that the Web Presenter server resend the complete state of any status block by sending the block header, followed by a blank line. In the following example, the user requests the Web Presenter server resend the stream settings:

```
STREAM SETTINGS:↵
↵
ACK↵
↵
STREAM SETTINGS:↵
Video Mode: 1080p59.94↵
...
↵
```

Protocol Blocks

Identity Block

The identity block contains information to identify the connected Web Presenter.

Block Syntax

The following example shows the Identity Block for a Blackmagic Web Presenter HD.

```
IDENTITY:↵
Model: Blackmagic Web Presenter HD↵
Label: Blackmagic Web Presenter HD↵
Unique ID: 00112233445566778899AABBCCDDEEFF↵
↵
```

Parameters

Key	Read/Write	Description	Valid Values
Model	Read only	The Web Presenter model name	String
Label	Read/Write	A display name for the Web Presenter	String
Unique ID	Read only	A device specific unique identifier	Hexadecimal ID

Changing Device Label

A device label to identify the Web Presenter can be changed by sending an identity block with label key.

```
IDENTITY:↵
Label: My Web Presenter↵
↵
ACK↵
↵
IDENTITY:↵
Label: My Web Presenter↵
↵
```

Version Block

The version block contains hardware and software version information for the connected Web Presenter.

Block Syntax

```
VERSION:↵  
Product ID: BE73↵  
Hardware Version: 0100↵  
Software Version: 0123ABCD↵  
Software Release: 3.3↵  
↵
```

Parameters

Key	Read/Write	Description	Valid Values
Product ID	Read only	The Web Presenter product ID	Hexadecimal ID
Hardware Version	Read only	The Web Presenter hardware version	Hexadecimal version
Software Version	Read only	The Web Presenter software version	Hexadecimal version
Software Release	Read only	The Web Presenter software release version	Version Number

Network Blocks

The network block contains the TCP/IP networking configuration for the connected Web Presenter.

Block Syntax

This example shows the output for a connected Web Presenter. It displays 2 networking interfaces - the Gigabit Ethernet interface and option for a tethered smartphone.

The network settings prefixed with Current show the active TCP/IP settings, and are read-only. The Current settings reflect either the DHCP or Static configuration, depending on the Dynamic IP flag.

```
NETWORK:↵  
Interface Count: 2↵  
Default Interface: 0↵  
↵  
NETWORK INTERFACE 0:↵  
Name: Ethernet↵  
Priority: 1↵  
MAC Address: 00:11:22:33:44:55↵  
Dynamic IP: true↵  
Current Addresses: 192.168.1.10/255.255.255.0↵  
Current Gateway: 192.168.1.1↵  
Current DNS Servers: 192.168.1.1, 8.8.8.8, 8.8.4.4↵  
Static Addresses: 10.0.0.2/255.255.255.0↵  
Static Gateway: 10.0.0.1↵  
Static DNS Servers: 8.8.8.8, 8.8.4.4↵  
↵
```

```

NETWORK INTERFACE 1:↵
Name: USBEthernet↵
Priority: 0↵
MAC Address: 00:00:00:00:00:00↵
Dynamic IP: true↵
Current Addresses: 0.0.0.0/255.255.0.0↵
Current Gateway: 0.0.0.0↵
Current DNS Servers: ↵
Static Addresses: 10.0.0.2/255.255.255.0↵
Static Gateway: 10.0.0.1↵
Static DNS Servers: 8.8.8.8, 8.8.4.4↵
↵

```

Parameters

Network Block

Key	Read/Write	Description	Valid Values
Interface Count	Read only	The number of networking interfaces supported by the Web Presenter	Integer
Default Interface	Read only	The default networking interface	Integer

Network Interface Block

Key	Read/Write	Description	Valid Values
Name	Read only	The name of the networking interface	String
Priority	Read/Write	The priority of the network interface. When multiple network interfaces are available, the high priority interface will become the default	Unsigned integer. The higher number is the higher priority
MAC Address	Read Only	MAC address of the networking interface	IEEE 802 MAC address
Dynamic IP	Read/Write	Selects DHCP or Static IP configuration	true - DHCP enabled false - Static IP
Current Addresses	Read Only	The current IP address and Subnet mask	{IPv4 address}/{Subnet Mask}
Current Gateway	Read Only	The current IP gateway address	IPv4 address
Current DNS Servers	Read only	The IP addresses of the current DNS servers	Comma separated list of IPv4 addresses
Static Addresses	Read/Write	Status IP address and subnet mask when DHCP disabled	{IPv4 address}/{Subnet Mask}
Static Gateway	Read/Write	Static gateway address when DHCP disabled	IPv4 address
Static DNS Servers	Read/Write	The IP addresses of the static DNS servers	Comma separated list of IPv4 addresses

Changing Networking Settings

The network can be configured to use either DHCP or a static configuration. To enable DHCP on Network Interface 0:

```
NETWORK INTERFACE 0:↵
```

```
Dynamic IP: true↵
```

```
↵
```

```
ACK↵
```

```
↵
```

```
NETWORK INTERFACE 0:↵
```

```
Dynamic IP: true↵
```

```
↵
```

To set a fixed IP address, supply all static parameters:

```
NETWORK INTERFACE 0:↵
```

```
Dynamic IP: false↵
```

```
Static Addresses: 192.168.1.2/255.255.255.0↵
```

```
Static Gateway: 192.168.1.1↵
```

```
Static DNS Servers: 8.8.8.8, 8.8.4.4↵
```

```
↵
```

```
ACK↵
```

```
↵
```

```
NETWORK INTERFACE 0:↵
```

```
Dynamic IP: false↵
```

```
Static Addresses: 192.168.1.2/255.255.255.0↵
```

```
Static Gateway: 192.168.1.1↵
```

```
Static DNS Servers: 8.8.8.8, 8.8.4.4↵
```

```
↵
```

Changing network settings may cause the IP connection to be dropped.

UI Settings Block

The UI settings block contains the front panel LCD and monitor output settings for the connected Web Presenter.

Block Syntax

```
UI SETTINGS:↵
```

```
Available Locales: en_US.UTF-8, zh_CN.UTF-8, ja_JP.UTF-8, ko_KR.UTF-8, es_
ES.UTF-8, de_DE.UTF-8, fr_FR.UTF-8, ru_RU.UTF-8, it_IT.UTF-8, pt_BR.UTF-8,
tr_TR.UTF-8, pl_PL.UTF-8, uk_UA.UTF-8↵
```

```
Current Locale: en_US.UTF-8↵
```

```
Available Audio Meters: PPM -18dB, PPM -20dB, VU -18dB, VU -20dB↵
```

```
Current Audio Meter: PPM -20dB↵
```

```
↵
```

Parameters

Key	Read/Write	Description	Valid Values
Available Locales	Read only	The locales available in the Web Presenter	Comma separated list of locales
Current Locale	Read/Write	The current locale for Web Presenter	Refer to the locales from the Available Locales field
Available Audio Meters	Read only	The available audio meters supported by the Web Presenter	Comma separated list of audio meter types
Current Audio Meter	Read/Write	The current audio meter	Refer to the audio meters from the Available Audio Meters field

Stream Settings Block

The stream settings block contains the stream configuration for the connected Web Presenter.

Block syntax

This example shows the output for a connected Web Presenter. The stream settings prefixed with Current show the active stream settings and are writable. The stream settings prefixed by Available show the available stream settings for the device or platform and are read-only. To view the available servers or quality levels for a stream service, the Current Platform stream setting should be set first.

```
STREAM SETTINGS:↵
Available Video Modes: Auto, 1080p23.98, 1080p24, 1080p25, 1080p29.97,
1080p30, 1080p50, 1080p59.94, 1080p60, 720p25, 720p30, 720p50, 720p60↵
Video Mode: 1080p59.94↵
Current Platform: YouTube↵
Current Server: Primary↵
Current Quality Level: Streaming Medium↵
Stream Key: abc1-def2-ghi3-jkl4-mno5↵
Password: ↵
Current URL: srt://192.168.8.51
Customizable URL: true
Available Default Platforms: YouTube RTMP, YouTube SRT (Beta), Facebook,
Twitch, Twitter, Restream.IO, Vimeo, BoxCast, CastR, AfreecaTV, Bilibili,
DouYu, Weibo↵
Available Custom Platforms: My Platform↵
Available Servers: Primary, Secondary↵
Available Quality Levels: HyperDeck High, HyperDeck Medium, HyperDeck Low,
Streaming High, Streaming Medium, Streaming Low↵
↵
```

Parameters

Key	Read/Write	Description	Valid Values
Available Video Modes	Read only	The video modes available in the Web Presenter	Comma separated list of video modes
Video Mode	Read/Write	The current video mode	Refer to the video modes from the <i>Available Video Modes</i> field
Current Platform	Read/Write	The selected streaming platform	Refer to the platforms from the <i>Available Default Platforms</i> and <i>Available Custom Platforms</i> fields
Current Server	Read/Write	The current server for the streaming platform	Server is dependent on selected Current Platform
Current Quality Level	Read/Write	The current streaming quality level	Quality level is dependent on selected Current Platform
Stream Key	Read/Write	The stream key for the streaming platform	String
Password	Read/Write	The passphrase for an encrypted SRT stream	String
Current URL	Read/Write	The current URL for the streaming platform. This field is writable if <i>Customizable URL</i> field is true.	String
Customizable URL	Read only	A boolean specifying whether custom URLs are supported by the streaming platform	true - Custom URLs are supported false - Custom URLs are not supported
Available Default Platforms	Read only	The available default streaming platforms	Comma separated list of default platforms
Available Custom Platforms	Read only	The custom streaming platforms loaded in the Web Presenter	Comma separated list of custom platforms
Available Servers	Read only	The available servers for the selected streaming platform	Comma separated list of servers
Available Quality Levels	Read only	The available quality levels for the selected streaming platform	Comma separated list of quality levels

Changing Stream Settings

The stream settings can be changed by providing a stream settings block. The following is an example of streaming a 1080p59.94 input on Twitch with a medium stream quality.

```

STREAM SETTINGS:↵
Video Mode: 1080p59.94↵
Current Platform: Twitch↵
Current Server: US West: Los Angeles, CA↵
Current Quality Level: Streaming Medium↵
Stream Key: live_123456789_1aB2cD3eF4gH5iJ6kL7mN8oP9qR0sT↵
↵
ACK↵
↵
STREAM SETTINGS:↵
Video Mode: 1080p59.94↵
Current Platform: Twitch↵
Current Server: US West: Los Angeles, CA↵
Current Quality Level: Streaming Medium↵
Stream Key: live_123456789_1aB2cD3eF4gH5iJ6kL7mN8oP9qR0sT↵
↵

```

Stream XML Block

The stream XML block allows users to configure the Web Presenter with a custom configuration file in XML format.

Block syntax

The following example shows an XML file - Custom.xml has been loaded to configure the stream settings in the Web Presenter.

```
STREAM XML:↵  
Files: Custom.xml↵  
↵
```

Parameters

Key	Read/Write	Description	Valid Values
Files	Read/Write	The XML files loaded in Web Presenter	Comma separated list of filenames
Action	Write only	The stream XML action	Remove Remove All

Adding a Stream XML file

An XML file can be loaded onto a Web Presenter by sending the stream xml command with a filename, then provide the contents of the XML file. After adding the XML file, the Available Custom Platforms field in the STREAM SETTINGS block will be updated with the new platforms, however the Current items will remain unchanged.

For the Stream XML block to be parsed correctly, any blank lines should be removed from the XML files.

Refer to the `Blackmagic Stream XML File Format` section in this manual for description of the Stream XML file format.

```
STREAM XML Custom.xml:↵  
<?xml version="1.0" encoding="UTF-8"?>↵  
<streaming>↵  
    <service>↵  
        <name>My Custom Platform</name>↵  
        ...  
    </service>↵  
</streaming>↵  
↵  
ACK↵  
↵  
STREAM XML Custom.xml:↵  
<?xml version="1.0" encoding="UTF-8"?>↵  
<streaming>↵  
    <service>↵  
        <name>My Custom Platform</name>↵  
        ...  
    </service>↵  
</streaming>↵  
↵
```

```
STREAM XML:↵
Files: Custom.xml↵
↵
STREAM SETTINGS:↵
Available Custom Platforms: My Custom Platform↵
↵
```

Removing a Stream XML file

An XML file can be removed from the Web Presenter by sending the stream xml command with the remove action.

```
STREAM XML:↵
Action: Remove↵
Files: Custom.xml↵
↵
ACK↵
↵
STREAM XML:↵
Files:↵
↵
STREAM SETTINGS:↵
Available Custom Platforms:↵
↵
```

Removing all Stream XML files

All XML files can be removed from the Web Presenter by sending the stream xml command with the remove all action. In the example, following the remove all action, the loaded stream XML files and available custom platforms are both displayed as empty.

```
STREAM XML:↵
Action: Remove All↵
↵
ACK↵
↵
STREAM XML:↵
Files: ↵
↵
STREAM SETTINGS:↵
Available Custom Platforms:↵
↵
```

Stream State Block

The stream state block provides the streaming status of the Web Presenter.

The Web Presenter server will send a stream state block update whenever there is a change to the Status field. Due to frequency of changes to Duration, Bitrate and Cache Used fields, these fields need to be polled by the client by requesting a Stream State block.

Block syntax

```
STREAM STATE:↵↵
Status: Idle↵↵
Bitrate: 161672↵↵
Duration: 00:00:00:00↵↵
Cache Used: 0↵↵
↵↵
```

Parameters

Key	Read/Write	Description	Valid Values
Status	Read only	The stream state of the Web Presenter, updated when the stream status changes	Idle Connecting Streaming Interrupted
Action	Write only	The Web Presenter stream state action.	Start Stop
Duration	Read only	The duration of the active stream	String in format of DD:HH:MM:SS
Bitrate	Read only	The bitrate of the active stream	Integer bits per second
Cache Used	Read only	The current usage of the streaming cache	Integer as a percentage

Starting Stream

The stream is started by providing a stream state block with start action.

```
STREAM STATE:↵↵
Action: Start↵↵
↵↵
ACK↵↵
↵↵
STREAM STATE:↵↵
Status: Connecting↵↵
↵↵
STREAM STATE:↵↵
Status: Streaming↵↵
↵↵
```

Stopping stream

The stream is stopped by providing a Stream State block with stop action.

```
STREAM STATE:↵↵
Action: Stop↵
↵
ACK↵
↵
STREAM STATE:↵↵
Status: Idle↵
↵
```

Audio Settings Block

The Audio Settings block contains the audio configuration for the connected Web Presenter.

Block syntax

This example shows the output for a connected Web Presenter. The stream settings prefixed with Current show the active audio settings and are writable. The stream settings prefixed by Available show the available audio settings for the device or platform and are read-only.

```
AUDIO SETTINGS:↵↵
Current Monitor Out Audio Source: Auto↵
Available Monitor Out Audio Sources: Auto, SDI In, Remote Source↵
↵
```

Parameters

Key	Read/Write	Description	Valid Values
Current Monitor Out Audio Source	Read/Write	The current audio source on the monitor output	Refer to the audio sources from the <i>Available Monitor Out Audio Sources</i> field
Available Monitor Out Audio Sources	Read only	The available audio sources that can be routed to the monitor output	Comma separated list of audio sources

Changing Audio Settings

The audio settings can be changed by providing an audio settings block. The following is an example of setting the monitor output audio source to remote.

```
AUDIO SETTINGS:↵↵
Current Monitor Out Audio Source: Remote Source↵
↵
ACK↵
↵
AUDIO SETTINGS:↵↵
Current Monitor Out Audio Source: Remote Source↵
↵
```

Shutdown Block

The Shutdown block provides power control of the Web Presenter. The Shutdown block is write-only and not presented in the preamble.

Parameters

Key	Read/Write	Description	Valid Values
Action	Write only	The Web Presenter shutdown action.	Reboot Factory Reset

Reboot

The Web Presenter can be rebooted by providing a Shutdown block with reboot action.

```
SHUTDOWN:↵
```

```
Action: Reboot↵
```

```
↵
```

```
ACK↵
```

```
↵
```

On reboot action, the Web Presenter server will be stopped and clients will be disconnected.

Factory Reset

The Web Presenter can be factory reset by providing a Shutdown block with factory reset action. On factory reset action, all settings are set to factory defaults.

```
SHUTDOWN:↵
```

```
Action: Factory Reset↵
```

```
↵
```

```
ACK↵
```

```
↵
```

Blackmagic Streaming XML Format

Overview

The Blackmagic Streaming XML allows users to specify streaming services in addition to the default services provided by the Web Presenter.

The Streaming XML can be loaded into the Web Presenter with Web Presenter Setup. Refer to the 'Using Web Presenter Setup' section earlier in this manual

The Streaming XML can also be loaded by copying the contents into the Stream XML block with the Blackmagic Web Presenter Ethernet Protocol.

The following is a minimal example of a Streaming XML file:

```
<?xml version="1.0" encoding="UTF-8"?>
<streaming>
  <service>
    <name>My Streaming Service</name>
    <servers>
      <server>
        <name>My Streaming Server</name>
        <url>rtmp://my.streaming-server.com/live</url>
      </server>
    </servers>
    <profiles>
      <profile>
        <name>My Streaming Quality</name>
        <config resolution="1080p" fps="60" codec="H264">
          <bitrate>7500000</bitrate>
        </config>
      </profile>
    </profiles>
  </service>
</streaming>
```

Streaming XML Definition

The Streaming XML file follows standard XML format and shall begin with XML declaration.

```
<?xml version="1.0" encoding="UTF-8"?>
```

Streaming Element

The Streaming XML file shall be contained by the <streaming> element. The <streaming> element will consist of 1 or more <service> child elements.

The following is an example of a <streaming> element block that defines 2 streaming services.

```
<streaming>
  <service>
    <name>Service 1</name>
    <!-- Streaming settings for "Service 1" -->
  </service>
  <service>
    <name>Service 2</name>
    <!-- Streaming settings for "Service 2" -->
  </service>
</streaming>
```

Service Element

The <service> element provides a description of the streaming service. If multiple streaming services are used, it is possible to define multiple <service> elements within each <streaming> element block.

The following is an example of a <service> element block in the Stream XML file.

```
<streaming>
  <service customizable-url="true">
    <name>My Streaming Service</name>
    <key>abc1-def2-ghi3-jkl4-mno5</key>
    <servers>
      <!-- Streaming server settings -->
    </servers>
    <profiles default="Streaming High">
      <!-- Streaming quality settings-->
    </profiles>
    <credentials>
      <!-- Streaming username and password settings -->
    </credentials>
  </service>
  <!-- <service> elements blocks for other streaming services -->
</streaming>
```

Attributes

Attribute	Optional/Required	Description
customizable-url	Optional	The service supports specifying custom URLs - supported = "true" or unsupported = "false" (default)

Child Elements

Element	Optional/Required	Description
<name>	Required	The name of the streaming service
<key>	Optional	The stream key for the streaming service
<servers>	Optional	The RTMP/SRT server settings of the streaming service (see below). May be omitted if customizable-url is true.
<profiles>	Required	The quality settings of the streaming service (see below)
<credentials>	Optional	The username and password of the streaming service (see below)

Servers Element

The <servers> element consists of 1 or more <server> child elements for defining the streaming server(s). The <servers> element is a required child of the <service> element. Defining multiple servers allows specifying localized and/or backup servers within a single XML description

The following is an example of a <servers> element block that defines a primary and secondary URL for the SRT server.

```
<service>
  ...
  <servers>
    <server group="Primary">
      <name>My Streaming Service Server</name>
      <url>srt://srt.my-streaming-service.com:2010</url>
      <srt-extensions>
        ...
      </srt-extensions>
    </server>
    <server group="Secondary">
      <name>My Streaming Service Backup Server</name>
      <url>srt://srt-backup.my-streaming-service.com:2010</url>
      <srt-extensions>
        ...
      </srt-extensions>
    </server>
    <!-- Additional <server> element blocks defining other
servers for streaming service -->
  </servers>
  ...
</service>
```

Attributes

Attribute	Optional/Required	Description
group	Optional	The logical grouping for the server

Child Elements

Element	Optional/Required	Description
<name>	Required	The name of the RTMP/SRT streaming server
<url>	Required	The URL of the RTMP/SRT streaming server
<srt-extensions>	Optional	Extended service block specific to SRT streaming server (see below)

SRT Extensions Element

The <srt-extensions> element consists of 1 or more child elements that define SRT specific parameters.

The following is an example of a <srt-extensions> element block for a primary stream identifier.

```
<service>
  ...
  <servers>
    <server group="Primary">
      ...
      <srt-extensions>
        <stream-id>
          <item key="copy" value="0"/>
        </stream-id>
      </srt-extensions>
    </server>
  </servers>
  ...
</service>
```

Child Elements

Element	Optional/Required	Description
<stream-id>	Required	Provides element with custom parameters for the stream ID. Each child element of stream-id has 1 or more item elements with a key/value pair.

Profiles Element

The <profiles> element consists of 1 or more <profile> child elements that define streaming quality. The <profiles> element is a required child of the <service> element. Defining multiple profiles allows specifying custom bitrates for different streaming qualities.

The following is an example of a <profiles> element block that defines 3 profiles.

```
<service>
  ...
  <profiles default="Streaming High">
    <profile>
      <name>Streaming High</name>
      <!-- Define <config> elements to specify target
bitrates for Streaming High profile -->
    </profile>
    <profile>
      <name>Streaming Medium</name>
      <!-- Define <config> elements to specify target
bitrates for Streaming Medium profile -->
    </profile>
  </profiles>
  ...
</service>
```

Attributes

Attribute	Optional/Required	Description
default	Optional	The name of the default profile

Child Elements

Element	Optional/Required	Description
<name>	Required	The name of the profile
<config>	Required	Video mode dependent quality settings for profile (see below)

Config Element

The <config> element defines a mapping between the video resolution and frame rate and the target bitrate for the quality level. The <config> element is a child of the <profile> element.

The following is an example of a <config> element block for setting the target bitrate for a high quality stream with 720p60 and 1080p60 video inputs.

```
<profile>
  <name>Streaming High</name>
  <config resolution="720p" fps="60" codec="H264">
    <bitrate>6000000</bitrate>
    <audio-bitrate>128000</audio-bitrate>
  </config>
  <config resolution="1080p" fps="60" codec="H264">
    <bitrate>8000000</bitrate>
    <audio-bitrate>128000</audio-bitrate>
  </config>
  <!-- <config> elements for other resolutions and frame rates -->
</profile>
```

Attributes

Attribute	Optional/Required	Description
resolution	Required	The resolution of the streaming video mode
fps	Required	The frame rate of the streaming video mode (frames per second)
codec	Optional	The codec for encoding the streaming video - "H264" (default) or "H265"

Child Elements

Element	Optional/Required	Description
<bitrate>	Required	The target bitrate of the streaming video (bits per second)
<audio-bitrate>	Optional	The target bitrate of the streaming audio (bits per second)

The supported streaming quality bitrates can be found in section `Using Web Presenter Setup` section earlier in this manual.

TIP For each <config> element block, choose a maximum resolution and fps to cover all video modes for the target bitrate. For example, defining a <config> element with resolution="1080p" and fps = "30" will apply for video modes 1080p23.98, 1080p24, 1080p25, 1080p29.97 and 1080p30.

For audio bitrate, only 128 Kb/s is supported.

Credentials Element

The <credentials> element allows specifying an RTMP session username and password if required by the service. The <credentials> element is an optional child to service element.

The following is an example of a <credentials> element block that defines a username and password for the streaming service.

```
<service>
  ...
  <credentials>
    <username>myusername</username>
    <password>abcd1234</password>
  </credentials>
  ...
</service>
```

Child Elements

Element	Optional/Required	Description
<username>	Required	RTMP session username
<password>	Required	RTMP/SRT session password

Pomoc

Uzyskiwanie pomocy

Najszybszym sposobem uzyskania pomocy jest wejście na strony wsparcia technicznego online Blackmagic Design i sprawdzenie najnowszych materiałów pomocniczych dostępnych dla Blackmagic Web Presenter.

Strony wsparcia technicznego online Blackmagic Design

Najnowszą instrukcję obsługi można znaleźć w centrum wsparcia technicznego na www.blackmagicdesign.com/pl/support

Forum Blackmagic Design

Forum Blackmagic Design na naszej stronie internetowej jest pomocnym źródłem dalszych informacji i kreatywnych pomysłów. Może to być też szybszy sposób uzyskania pomocy. Być może istnieją już odpowiedzi na podobne pytania od innych doświadczonych użytkowników i pracowników Blackmagic Design, którzy mogą Ci pomóc. Forum znajdziesz pod adresem <https://forum.blackmagicdesign.com>

Kontakt z obsługą techniczną Blackmagic Design

Jeśli nie możesz znaleźć potrzebnej pomocy w naszych materiałach lub na forum, użyj przycisku **Wyślij do nas e-mail** na stronie wsparcia technicznego, aby wysłać zgłoszenie dotyczące pomocy technicznej. Alternatywnie kliknij na stronie przycisk **Znajdź lokalny zespół pomocy technicznej** i zadzwoń do najbliższego biura pomocy technicznej Blackmagic Design.

Wymogi prawne



Utylizacja zużytego sprzętu elektrycznego i elektronicznego na terenie Unii Europejskiej.

Symbol na produkcie oznacza, że tego urządzenia nie wolno utylizować razem z innymi odpadami. Aby zutylizować zużyty sprzęt, należy przekazać go do wyznaczonego punktu zbiórki w celu recyklingu. Oddzielna zbiórka i recykling zużytego sprzętu w czasie utylizacji pomoże oszczędzić zasoby naturalne i zapewni, że zostanie on poddany recyklingowi w sposób chroniący zdrowie ludzi i środowisko. Więcej informacji na temat miejsc, w których można oddać zużyty sprzęt do recyklingu można uzyskać w lokalnym biurze ds. recyklingu w Twoim mieście lub u sprzedawcy, od którego zakupiłeś produkt.



Niniejsze urządzenie zostało przetestowane i uznane za zgodne z ograniczeniami dla urządzeń cyfrowych klasy A, zgodnie z częścią 15 przepisów FCC. Ograniczenia te zostały opracowane w celu zapewnienia rozsądnej ochrony przed szkodliwymi zakłóceniami podczas pracy urządzenia w środowisku komercyjnym. Tego typu sprzęt generuje, wykorzystuje i może wypromieniowywać energię o częstotliwości radiowej. Jeśli nie jest zainstalowany i używany zgodnie z instrukcją, może powodować szkodliwe zakłócenia w komunikacji radiowej. Użytkowanie tego produktu na terenach zamieszkałych może powodować szkodliwe zakłócenia, w którym to przypadku użytkownik będzie zobowiązany do usunięcia zakłóceń na własny koszt.

Działanie podlega dwóm następującym warunkom:

- 1 Niniejsze urządzenie nie może powodować szkodliwych zakłóceń.
- 2 Niniejsze urządzenie musi odbierać wszelkie zakłócenia zewnętrzne, w tym zakłócenia mogące powodować niepożądane funkcjonowanie.



R-R-BMD-20201201001
R-R-BMD-20201201002

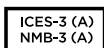

Certyfikacja ISED na rynek kanadyjski

Niniejsze urządzenie jest zgodne z kanadyjskimi normami dla urządzeń cyfrowych klasy A.

Wszelkie modyfikacje lub użycie tego produktu niezgodnie z jego przeznaczeniem może unieważnić zgodność z tymi normami.

Podłączenie do interfejsów HDMI musi być wykonane przy użyciu wysokiej jakości ekranowanych kabli HDMI.

Niniejsze urządzenie zostało przetestowane pod kątem zgodności z przeznaczeniem do użytku w środowisku komercyjnym. Jeśli urządzenie jest używane w środowisku domowym, może powodować zakłócenia radiowe.

Informacje dotyczące bezpieczeństwa

Urządzenie musi być podłączone do gniazda sieciowego z uziemieniem ochronnym.

Aby zmniejszyć ryzyko porażenia prądem, nie należy narażać urządzenia na kapanie lub zachlapanie.

Niniejsze urządzenie nadaje się do użytku na obszarach tropikalnych o temperaturze otoczenia do 40°C.

Zakres temperatur przechowywania wynosi od -20°C do 60°C, a przy wilgotności względnej od 0% do 90% kondensacja nie występuje.

Należy upewnić się, że wokół produktu zapewniona jest odpowiednia, nieograniczona wentylacja.

Podczas montażu w stojaku należy upewnić się, że wentylacja nie jest ograniczona przez sąsiednie urządzenia.

Urządzenie nie zawiera żadnych części, które mogą być naprawiane przez użytkownika. Serwisowanie należy zlecić lokalnemu centrum serwisowemu Blackmagic Design.



Stosować wyłącznie na wysokościach nie większych niż 2000 m n.p.m.

Kalifornijskie ostrzeżenie Prop 65

Niniejszy produkt może narażać użytkownika na działanie substancji chemicznych, takich jak śladowe ilości polibromowanych bifenyli w częściach plastikowych uznanych w stanie Kalifornia za powodujące raka i uszkodzenia płodu lub działające szkodliwie dla rozrodczości.

Więcej informacji na stronie www.P65Warnings.ca.gov.

Gwarancja

36 miesięcy ograniczonej gwarancji

Firma Blackmagic Design gwarantuje, że urządzenie Blackmagic Web Presenter będzie wolne od wad materiałowych i produkcyjnych przez okres 36 miesięcy od daty zakupu, z wyłączeniem złączy, kabli, modułów światłowodowych, bezpieczników i akumulatorów, które będą wolne od wad materiałowych i produkcyjnych przez okres 12 miesięcy od daty zakupu. Jeśli produkt okaże się wadliwy w okresie gwarancyjnym, Blackmagic Design, według własnego uznania, albo naprawi wadliwy produkt bez opłat za części i koszty naprawy, albo zapewni wymianę na produkt zastępczy w zamian za wadliwy produkt.

W celu uzyskania usługi w ramach niniejszej gwarancji, klient musi powiadomić Blackmagic Design o wadzie przed upływem okresu gwarancyjnego i dokonać odpowiednich przygotowań do wykonania usługi. Klient jest odpowiedzialny za zapakowanie i opłacenie wysyłki wadliwego produktu do wyznaczonego centrum serwisowego wskazanego przez Blackmagic Design. Klient jest odpowiedzialny za opłacenie wszystkich kosztów wysyłki, ubezpieczenia, ceł, podatków i innych opłat za produkty zwrócone do nas z jakiegokolwiek powodu.

Niniejsza gwarancja nie obowiązuje w przypadku wad, awarii lub uszkodzeń spowodowanych niewłaściwym użytkowaniem lub niewłaściwą lub niedostateczną konserwacją i pielęgnacją. W ramach niniejszej gwarancji firma Blackmagic Design nie jest zobowiązana do świadczenia następujących usług serwisowych: a) naprawy uszkodzeń wynikających z prób instalacji, naprawy lub serwisowania produktu przez personel inny niż przedstawiciele Blackmagic Design, b) naprawy uszkodzeń wynikających z niewłaściwego użytkowania lub podłączenia do niekompatybilnego sprzętu, c) naprawy wszelkich uszkodzeń lub nieprawidłowego działania spowodowanego użyciem części lub materiałów eksploatacyjnych innych niż Blackmagic Design, lub d) serwisowania produktu, który został zmodyfikowany lub zintegrowany z innymi produktami, jeśli w wyniku takiej modyfikacji lub integracji zwiększa się czas lub trudność serwisowania produktu. NINIEJSZA GWARANCJA UDZIELANA PRZEZ BLACKMAGIC DESIGN ZASTĘPUJE WSZELKIE INNE GWARANCJE, WYRAŹNIE OKREŚLONE LUB DOROZUMIANE. BLACKMAGIC DESIGN I JEJ DOSTAWCY WYŁĄCZAJĄ WSZELKIE DOROZUMIANE GWARANCJE PRZYDATNOŚCI HANDLOWEJ LUB PRZYDATNOŚCI DO OKREŚLONEGO CELU. ODPOWIEDZIALNOŚĆ BLACKMAGIC DESIGN ZA NAPRAWĘ LUB WYMIANĘ WADLIWYCH PRODUKTÓW JEST JEDYNYM I WYŁĄCZNYM ZADOŚĆUCZYNIENIEM ZAPEWNIONYM KLIENTOWI ZA WSZELKIE SZKODY POŚREDNIE, SZCZEGÓLNE, PRZYPADKOWE LUB WYNIKOWE, NIEZALEŻNIE OD TEGO, CZY BLACKMAGIC DESIGN LUB DOSTAWCA ZOSTALI WCZEŚNIEJ POWIADOMIENI O MOŻLIWOŚCI WYSTĄPIENIA TAKICH SZKÓD. BLACKMAGIC DESIGN NIE PONOSI ODPOWIEDZIALNOŚCI ZA JAKIEKOLWIEK NIELEGALNE UŻYCIE SPRZĘTU PRZEZ KLIENTA. FIRMA BLACKMAGIC NIE PONOSI ODPOWIEDZIALNOŚCI ZA JAKIEKOLWIEK SZKODY WYNIKAJĄCE Z UŻYTKOWANIA NINIEJSZEGO PRODUKTU. UŻYTKOWNIK OBSŁUGUJE TEN PRODUKT NA WŁASNE RYZYKO.

© Copyright 2023 Blackmagic Design. Wszelkie prawa zastrzeżone. „Blackmagic Design”, „DeckLink”, „HDLink”, „Workgroup Videohub”, „Multibrige Pro”, „Multibrige Extreme”, „Intensity” i „Leading the creative video revolution” są zarejestrowanymi znakami towarowymi w Stanach Zjednoczonych i innych krajach. Wszystkie inne nazwy firm i produktów mogą być znakami towarowymi odnośnych przedsiębiorstw, z którymi są powiązane.

Thunderbolt i logo Thunderbolt są znakami towarowymi Intel Corporation w Stanach Zjednoczonych i/lub innych krajach.